



Prestigio

THE ART OF HI-TECH



MultiPad 4 Quantum 9.7

PMP5297C_QUAD_COL

Tablet PC

User Manual

Version 1.0

www.prestigio.com

About this user manual

This user manual is specially designed to detail the device's functions and features.

- Please read this manual before using the device to ensure safe and proper use.
- Descriptions are based on the device's default settings.
- Images and screenshots may differ in appearance from the actual product.
- Prestigio continuously strives to improve its products. Due to software upgrading, some contents in this user manual may be different from your product. Prestigio reserves the rights to revise this user manual or withdraw it at any time without prior notice. Please take your product as standard.
- The Android Applications which are provided by your device have been developed by Android's users or other companies, not by Prestigio and are provided at no charge. Unless indicated, otherwise, Prestigio makes no promises nor representations and takes no responsibilities about their performance, quality, content or intellectual property rights.

Conventions used in this manual

In this user manual, we use the following symbols to indicate useful and important information:



Caution: provides safety precaution and important information.



Note: gives additional information.



Tips: usage tips.

> The order of options or menus you must select to perform a step.

Contents

1. Unboxing	1
Open your package	1
Your tablet at a glance	1
Buttons.....	1
2. Getting started.....	2
Insert a memory card.....	2
Power on your tablet	2
Home screens.....	3
List menu.....	4
3. Basics	5
Finger tips.....	5
Motion gesture	6
Charge the battery	6
Connect to your PC	7
Lock and unlock the screen.....	7
Voice control	9
Recently used apps	9
Notifications panel	9
Enter text	11
Use widgets.....	12
System upgrade	12
Status icons	13
4. Web & network.....	14
Connect to Internet.....	14
VPN.....	16
Web browse	17
5. Apps.....	19
Play store.....	19
Manage your apps.....	19
6. Mail	20
Set up an email account.....	20
Send a mail.....	20
View your mails.....	20
Reply to a mail.....	21
Delete mails	21
Gmail	21
7. Camera	23

Your camera at a glance	23
Take a photo	24
Take a photo of yourself	24
Take a panoramic photo	24
Record a video	24
Camera scenes	24
Camera settings	24
8. Multimedia	25
Gallery	25
Video player	28
Music player	28
Sound recorder	30
9. Bluetooth	31
Turn on or off Bluetooth	31
Pair with a Bluetooth device	31
Unpair with a Bluetooth device	31
Send data via Bluetooth	31
Receive data via Bluetooth	31
10. eReader Prestigio	32
Your eReader at a glance	32
Download an eBook	32
Read an eBook	32
eReader settings	33
11. Travel & maps	34
Find a location	34
Get directions	34
Use Google maps	35
12. My files and storage	36
My files	36
Storage	36
13. Utilities	37
Clock	37
Calendar	38
Calculator	38
Google search	38
14. Set up your tablet	40
Wireless & Networks	40
Device	40
Personal	41

Accounts.....	41
System.....	41
15. Specifications	43
16. Troubleshooting.....	44

1. Unboxing

1





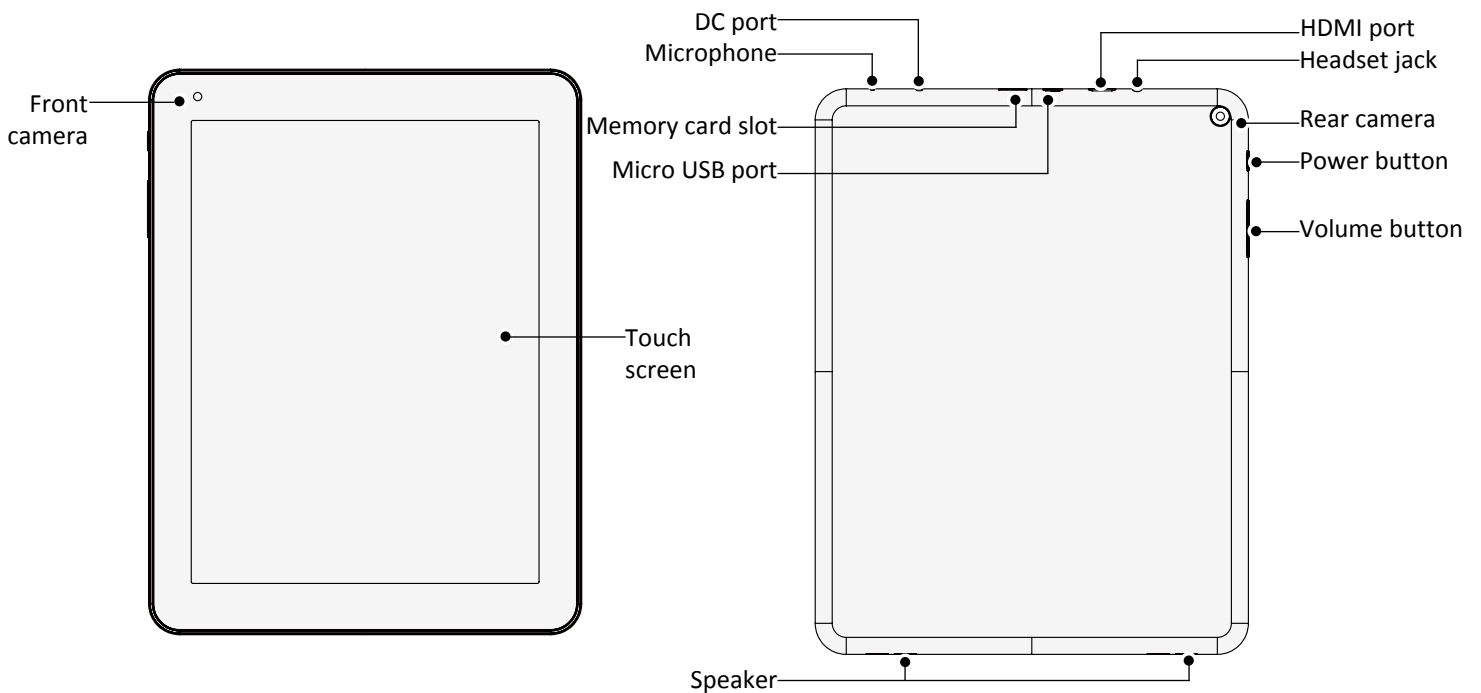

Open your package

- Prestigio MultiPad
- Travel charger
- Carrying case
- USB cable
- OTG cable
- Quick start guide
- Legal and safety notices
- Warranty card

Your tablet at a glance



Buttons

Button	Definition	Function
	Power	<ul style="list-style-type: none">• Press and hold to power on or off your tablet.• Press to lock or unlock the screen display.
	Volume	<ul style="list-style-type: none">• Press to adjust the volume.
	Back	<ul style="list-style-type: none">• Tap to return to the previous screen.• Tap to hide the onscreen keyboard when it is opened.
	Home	<ul style="list-style-type: none">• Tap to return to home screen.
	Recent app	<ul style="list-style-type: none">• Tap to open the list of recent apps.
	List menu	<ul style="list-style-type: none">• Tap to open the list menu.

2. Getting started

2

Congratulations on your purchase and welcome to Prestigio. To get the most from your product and enjoy all Prestigio has to offer, please access:

<http://www.prestigio.com/catalogue/MultiPads>

More details about your product, please access:

<http://www.prestigio.com/support>



Please read the "Legal and safety notices" on your package before use.



- Do not cover the antenna area with your hands or other objects. This may cause connectivity problems.
- Do not allow water to contact the touch screen. The touch screen may malfunction in humid conditions or when exposed to water.

Insert a memory card

You can expand the memory of your tablet and store more additional multimedia files by adding a micro-SD card. Depending on the memory card manufacturer and type, some memory cards may not be compatible with your device.

1. Insert a memory card with the gold-coloured contacts facing downwards.
2. Push the memory card into the slot until it locks in place.

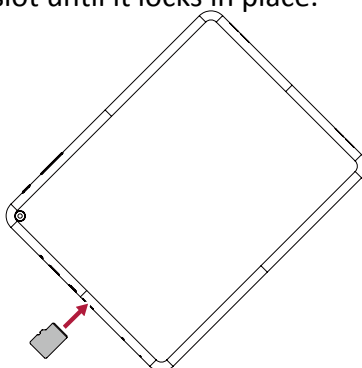

Some memory cards may not be fully compatible with the device. Using an incompatible card may damage the device or the memory card, or corrupt the data stored in it.



- Frequent writing and erasing of data shortens the lifespan of memory cards.
- When inserting a memory card into the device, the memory card's file directory appears in the **Explorer > SD card**.



Remove the memory card: push the memory card until it disengages from the device, and then pull it out.

Power on your tablet

Press and hold the Power button for a few seconds to power on your tablet.

1. When turning on the device for the first time, follow the on-screen instructions to set up your device.
2. After setting up your tablet, there is an Installer Prestigio wizard appears on the screen. It offers

you some third-party apps, tap the apps you want to install on your tablet. Follow the on-screen instructions to install the apps.

3. It might take a certain time for your tablet to install the apps.

 To turn off your tablet, press and hold the Power button, and then tap **Power off** on the pop up screen.

 If you do not install the apps provided by the Installer Prestigio wizard for the first time, you can tap **Installer Prestigio** on the home screen to install the apps next time.

Home screens

Your Home screen is the starting point to access all of the tablet's features. The Home screen can have multiple panels. To view other panels, swipe left or right. Tap  to return to the center home screen. You can add your favorite applications, shortcuts, folders and widgets, so they're always just a tap away. Your tablet's home screen consists of the following areas:

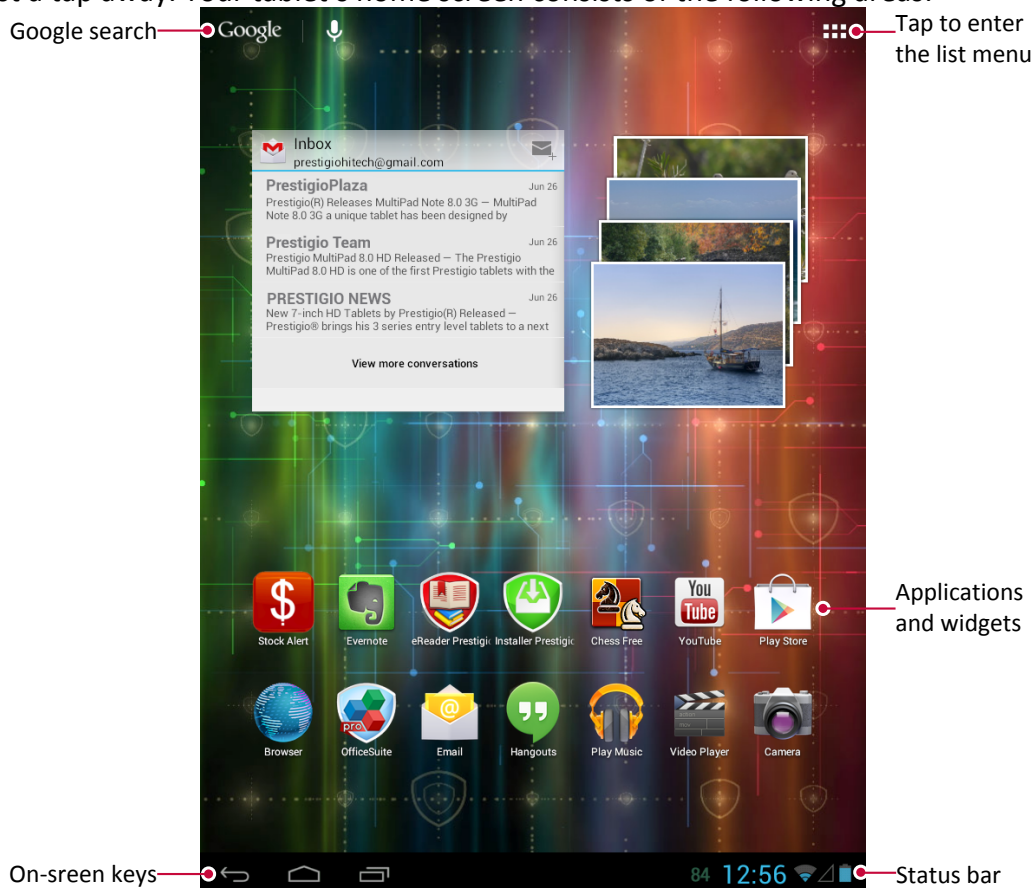

Set wallpaper

Pick your favorite photo as your Home wallpaper. Choose from the available wallpapers, or use any photo you've taken with the camera.

1. Tap and hold the blank area on the Home screen.
2. Select one of the following: **Gallery**, **Live wallpapers** or **Wallpapers**.
3. Select an image and tap **Set wallpaper**. Or, select an image, resize it by dragging the frame, and then tap **OK**.



Add an app icon to home screen

1. On the Home screen, tap  to open the list menu.
2. Tap and hold an application icon.
3. Drag it into a panel preview.

Remove an item on the Home screen

1. Tap and hold an item to remove.
2. The **Remove** option appears at the top of the Home screen.
3. Drag the item to the **Remove** option.
4. When the **Remove** option turns red, release the item.

List menu

All yours apps' icons can be found on the list menu. You also can find all the widgets of the apps on the list menu. On home screen, tap  to open list menu. The list menu can have multiple panels. To view other panels, swipe left or right. Tap  or  to return to the home screen. Your tablet's list menu consists of the following areas:

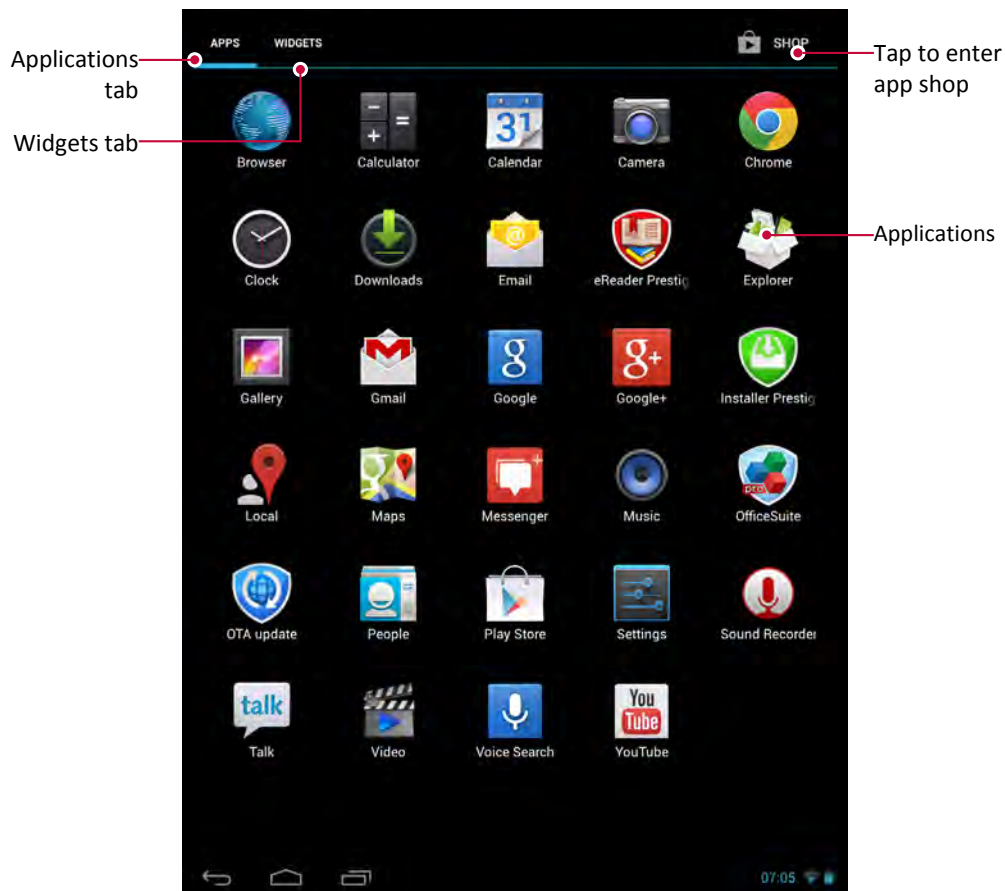

3. Basics

3

Finger tips

Only use your fingers to use the touch screen.

Tap

To open an application, to select a menu item, to press an on-screen button, or to enter a character using the on-screen keyboard, tap it with a finger.

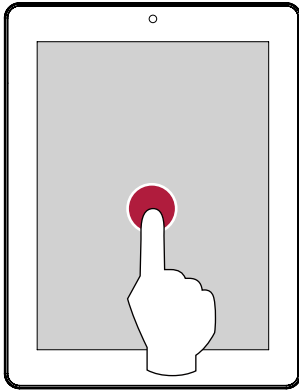

Tap and hold

Tap and hold an item for more than 2 seconds to access available options.

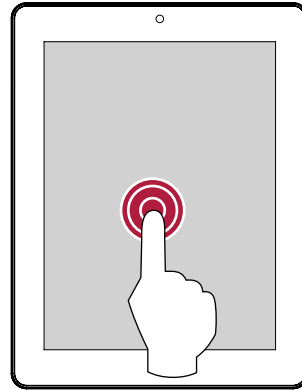

Swipe

Quickly swipe your finger vertically or horizontally across the screen to go to other Home pages, scroll through documents, and more.

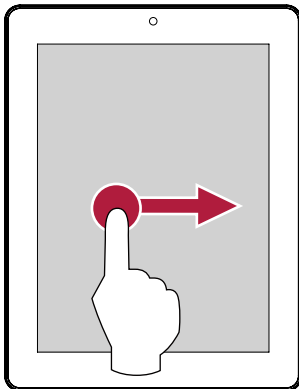

Slide

Slide your finger vertically across the screen to open drop-down menu.

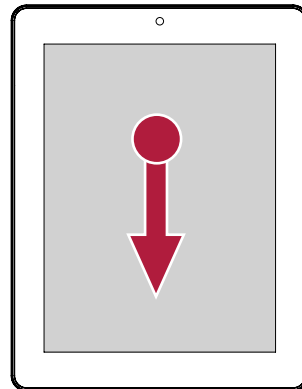

Zoom in

Spread two fingers apart on a webpage, map, or image to zoom in a part.

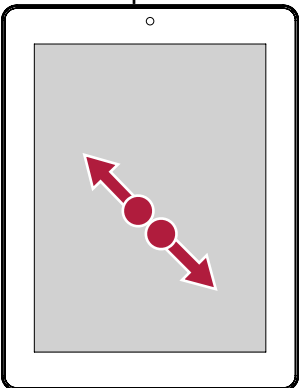

Zoom out

Pinch two fingers together on a webpage, map, or image to zoom out a part.

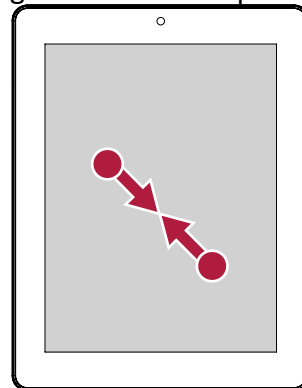

Scroll

Drag up or down to scroll. On some screens, such as webpages, you can also scroll side to side.

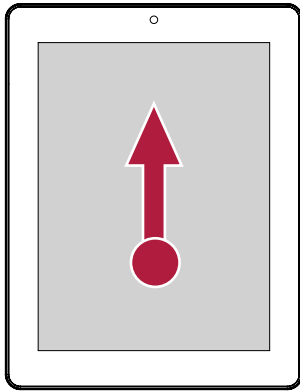

Flick

Flick left or right on the Home screen or the Applications screen to see another panel. Flick up or down to scroll through a webpage or a list, such as contacts.

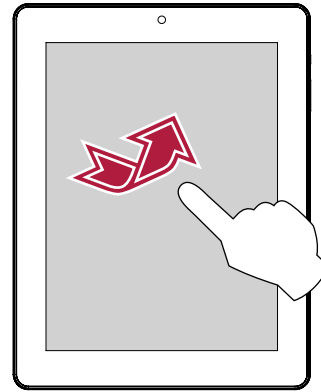

Motion gesture

Rotate your tablet for a better view

For many screens, you can automatically change the screen orientation from portrait to landscape by turning your tablet sideways. When entering text, you can turn your tablet sideways to bring up a bigger keyboard.

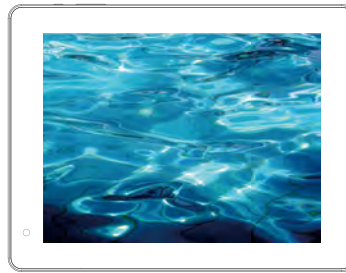
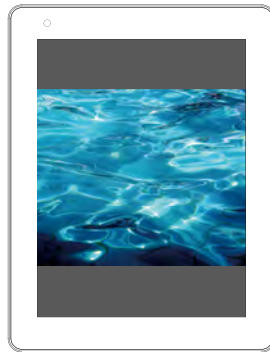

To prevent the display from rotating automatically, open the notifications panel and deselect **Auto rotation**.



- Some applications do not allow screen rotation.
- Some applications display a different screen depending on the orientation.

Charge the battery

A new battery is partially charged. The battery icon in the lower-right corner shows the battery level of charging status.

1. Plug the small end of the charger into the micro USB port of the device, and plug the large end of the charger into an electric socket.

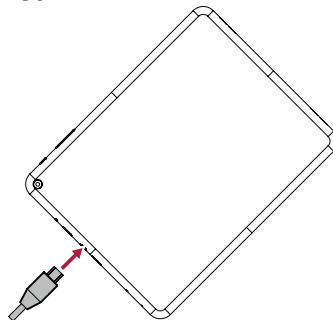

2. After fully charging, disconnect the device from the charger. First unplug the charger from the device, and then unplug it from the electric socket.



Always use authentic accessories as they enable your tablet to perform at its peak. Nonauthentic accessories (eg. chargers) may damage your tablet.



- You can use the tablet while it is charging.
- The only way to turn off the charger is to unplug it, so it is advisable to use an easily accessible power socket.

Optimize your battery performance

Here are some steps to help you optimize your battery performance.

- Always ensure that your tablet profile is appropriately set to meet your actual usage. Profile setting significantly impacts the tablet's battery performance. In general, Outdoor Mode is the most power-draining setting while Silent Mode consumes the least amount of power.
- If you're not using applications like Bluetooth, WIFI, GPS and Apps, turn them off. And be sure to lock your tablet to prevent accidental pressing of the keys with the auto-lock feature.
- Adjust the intensity and duration of your display screen's backlight to low or medium level and for the shortest duration. In general, the lower the backlight level and the shorter the duration, the more power you will save.
- Avoid using or placing your tablet near magnetic objects (eg. a radio or television) or on metal surfaces, which will impact the network connection and ultimately drain power from your battery.

Connect to your PC

Your tablet's micro USB port allows you exchange media and other files with a connected computer.

- Connect your tablet to the PC using the supplied USB cable.

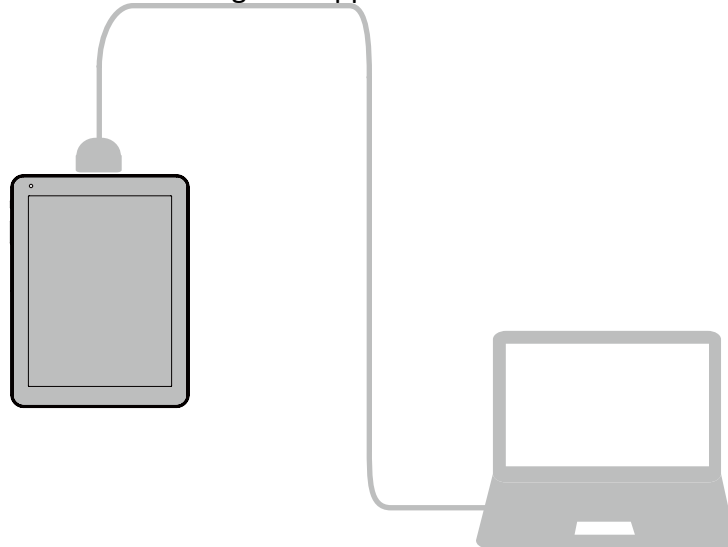

Load files from your PC

1. Connect your tablet to the PC by using the USB cable.
2. Slide to open notification panel, tap **Connected as Media device**.
3. Tap to select **Mass storage** in Storage settings screen.
4. Slide to open notification panel again, tap **USB connected**.
5. Tap to turn on USB storage.
6. Transfer files between your tablet and the PC.

Lock and unlock the screen

When not in use, lock your tablet to prevent unwanted operation and save the battery.

- Lock: press the power button.



When your tablet is locked, nothing happens if you touch the screen.

Your tablet can still:

- Receive messages, and other updates.
- Play music.
- Adjust the volume.

You can use the headset to listen to music.

- Unlock: press the power button, and then slide the lock icon to unlock your screen.

Auto lock

You can set an time span for the screen to be locked automatically.

1. On home screen, tap  to open list menu.
2. Tap **Settings > Display > Sleep**.
3. Select your desired time span.

Set screen lock pattern

Protect your personal information and prevent others from using your tablet without your permission by setting a screen lock pattern, face unlock, PIN, or password. You'll be asked to unlock the screen every time your tablet is powered on or when it's idle for a certain period of time.

1. On home screen, tap  to open list menu.
2. Tap **Settings > Security > Screen lock**.

Setting a slide unlock

1. On home screen, tap  to open list menu.
2. Tap **Settings > Security > Screen lock > Slide**.

Setting a face unlock

1. On home screen, tap  to open list menu.
2. Tap **Settings > Security > Screen lock > Face Unlock**.
3. Fit your face in the frame to be captured.

Setting a pattern

1. On home screen, tap  to open list menu.
2. Tap **Settings > Security > Screen lock > Pattern**.
3. Draw a pattern by connecting four dots or more, and then draw the pattern again to verify it.

Setting a PIN

1. On home screen, tap  to open list menu.
2. Tap **Settings > Security > Screen lock > PIN**.
3. Enter at least four numbers, and then enter the password again to verify it.

Setting a password

1. On home screen, tap  to open list menu.
2. Tap **Settings > Security > Screen lock > Password**.
3. Enter at least four characters including numbers and symbols, and then enter the password again to verify it.

Unlock your tablet

Turn on the screen by pressing the Power button, and enter the unlock code.

If you've forgotten your screen lock pattern, you have up to five attempts to try and unlock your tablet. If this fails, take the device to dealer to reset it.

Voice control

Voice Control lets you make phone calls and control music playback using voice commands.

Use Voice Control: press the volume button to adjust the volume. Press the top of the button to volume up, and press the bottom of the button to volume down.



Recently used apps

You can easily access apps you've just recently opened.

1. Tap  to open the list of recently-used apps.
 2. Slide your finger to see recently-opened apps.
 - To switch back to an app, just tap it.
 - To remove an app from the list, swipe it.
-



Notifications panel

To help make sure you don't miss important events, many apps can provide alerts. An alert can appear briefly as a banner at the bottom of the screen, which goes away if you don't respond to it. When you get a new notification, you can open the Notifications panel to see what event notification or new information you have received. You can also quickly access settings from the Notifications panel.

- To open the Notifications panel, drag up the status bar on the bottom of the screen.
- To close the Notifications panel, tap the page screen or drag up the status bar again.
- To dismiss the notification, tap .
- To enter quick settings list, tap .

Using Quick Settings

The Quick Settings tab provides a quick shortcut to turn on Airplane mode, Wi-Fi, set the brightness, auto rotation and lets you easily access Settings.

- Tap  or  to switch between notifications and quick setting list.

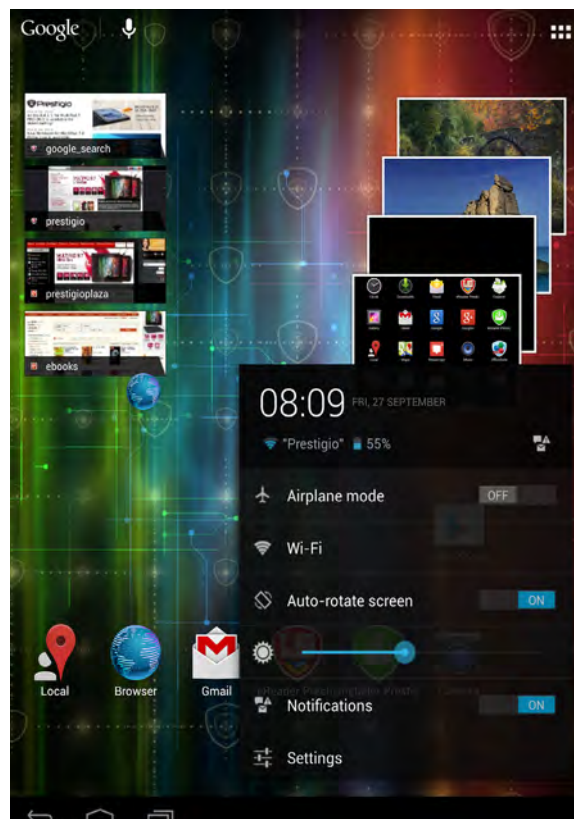

You can view your tablet's current status and use the following options:

- Airplane mode: turn on or off your tablet's wireless radios.
- Wi-Fi: activate or deactivate the Wi-Fi feature.
- Auto-rotate screen: allow or prevent the interface from rotating when you rotate the device.
- Brightness: adjust the brightness of the screen.
- Notifications: turn on or off your tablet's notifications.
- Settings: enter system settings to set up your tablet.

Enter text

Use the onscreen keyboard to enter text, such as contact information, mail, and web addresses. Depending on the app and the language you're using, the keyboard may correct misspellings, predict what you're typing, and even learn as you use it.

Change the input method

You can download an input app or use the input method pre-installed on your tablet. To change the input method, follow the steps:

1. On home screen, tap  to open list menu.
2. Tap **Settings > Language & input > Default**.
3. Choose the desired input method.



Use the Prestigio keyboard

Tap a text field to bring up the keyboard, then tap keys on the keyboard. You can enter the text in QWERTY keyboard.



Enter the text

As you type, each letter appears above your thumb or finger. The letter isn't entered until you choose your desired word.

- Type uppercase: tap the Shift key  before tapping a letter. Or touch and hold the Shift key, then tap a letter.
- Type lowercase: tap the Shift key again and then tap a letter.
- Enter numbers, symbols or punctuation: tap .

Enter text by voice

You also can enter the text by activating the voice input feature and then speak into the microphone. Your phone displays what you speak.

Voice typing: open the Prestigio keyboard, tap and hold .

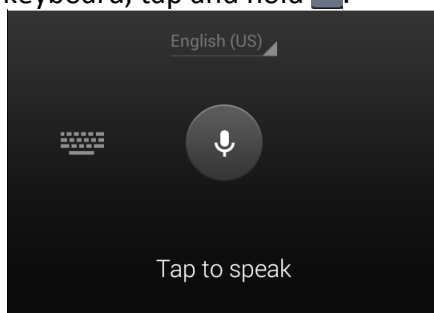

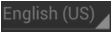
- If the device does not recognise your words correctly, tap the underlined text and select an alternative word or phrase from the dropdown list.
- To change the language or add languages for the voice recognition, tap  and select **Add more languages**.

Copy and paste text

1. After you have selected the text you want to copy, tap . The selected text is then copied to the clipboard.
2. In a text entry field, press at the point where you want to paste the text.
3. Tap **Paste**.

Move a text

1. After you have selected the text you want to cut, tap . The selected text is then cut to the clipboard.
2. In a text entry field, press at the point where you want to paste the text.
3. Tap **Paste**.

Use widgets

Widgets put at-a-glance important information and media content up front on your Home screen. Some widgets are already added to your Home screen for your convenience. You can add more from the available selections of widgets.

Add a widget to the Home screen

1. On home screen, tap  to open the list menu.
2. Tap **WIDGETS** to open widgets list.
3. Scroll left or right on the widgets panel.
4. Tap and hold the desired widgets to add it to the home screen.



- Some widgets connect to web services. Using a web-based widget may result in additional charges.
- The widgets available may vary depending on the region or service provider.

System upgrade

Your tablet can check and notify you if there's a new upgrade available. You can also manually check if there's an available update.

You can set this option in **Settings > About tablet > System updates**.

















Do not press any buttons while the device is upgrading.

Status icons

The icons in the status bar at the bottom of the screen give information about your tablet:



Icons	What it means	Icons	What it means
	Silent mode activated.		3G network connected.
	Vibration mode activated.		Wi-Fi connected.
	Flight mode activated.		Bluetooth is activated.
	Battery power level.		Connected to PC.
	GPRS network connected.		Wired microphone headset connected.
	EDGE network connected.		Wired headset connected.
	HSPA network connected.		Alarm is set.

4. Web & network

4

You can connect your tablet to Internet and browse a webpage on the website.

Connect to Internet

Your tablet connects to the Internet whenever necessary, using a Wi-Fi connection (if available) or 3G Dongle's data connection.



Connect your tablet with 3G Dongle by OTG cable.

Data connection

You can use 3G Dongle's data connection. Some apps and services may transfer data over your 3G Dongle's cellular network, which may result in additional fees. Contact your network operator for details.

Turn on or off data connection

1. On the home screen or list menu, tap **Settings**.
 - Or, tap  on Quick Setting list.
2. Tap **More...** > **Mobile networks** > **Data connection**.
3. Tap to turn on or off data connection.





If you don't have the data connection turned on and you're also not connected to a Wi-Fi network, you won't receive automatic updates to your email, social network accounts, and other synced information.

Add a new access point

Access Point Names (APNs) connect your tablet to data networks for services such as web browsing.



Before you add another data connection, have the access point name and settings from your network operator ready (including username and password if required).

1. On the home screen or list menu, tap **Settings**.
 - Or, tap  on Quick Setting list.
2. Tap **More...** > **Mobile networks** > **Access Point Names**.
3. On the APNs screen, tap  > **New APN**.
4. Enter the APN settings.
5. Tap  > **Save**.
6. Select the new APN on the APNs screen.

Turn on or off data roaming

Connect to your operator's partner networks and access data services when you're out of your network operator's coverage area.



Using data services while roaming may be costly. Check with your network operator for data roaming rates before you use data roaming.

1. On the home screen or list menu, tap **Settings**.

- Or, tap  on Quick Setting list.
2. Tap **More...** > **Mobile networks** > **Data roaming**.
 3. Tap to turn on or off data roaming.

Keep track of your data usage

If you're on a limited data allowance, it's important to keep track of the activities and apps that usually send and receive data, such as browsing the web, syncing online accounts, and sending email or sharing status updates.



To help you save on data usage, connect to a Wi-Fi network whenever possible and set your online accounts and emails to sync less frequently.



Data usage measured by your tablet may vary with your actual data usage.

1. On the home screen or list menu, tap **Settings**.
 - Or, tap  on Quick Setting list.
2. Tap **Data usage**.
3. Turn on data connection, select **Set mobile data limit** to automatically disable your data connection when you reach the set limit.
4. Tap **Data usage cycle**, you can set a particular time interval to see how much data you've used.
5. Drag the red line marker to set your monthly data limit.



• If you're connecting your tablet to another portable Wi-Fi hotspot, tap  > **Mobile hotspots** to restrict background data from downloading that may incur extra data fees.

Check the data usage of apps

1. On the home screen or list menu, tap **Settings**.
 - Or, tap  on Quick Setting list.
2. Tap **Data usage**.
3. Drag the vertical line markers to see how much data you've used during a particular time interval.
4. Scroll down the screen to see a list of apps and their data usage info.
5. Tap an app to see more details.

Wi-Fi

Connect the device to a Wi-Fi network to use the Internet or share media files with other devices. To use Wi-Fi, you need access to a wireless point or hotspot.



The availability and strength of the Wi-Fi signal will vary depending on objects, such as buildings or simply a wall between rooms, the Wi-Fi signal has to pass through.

Turn on or off Wi-Fi

Do the following method:

- Open notification panel, switch to quick setting list, and then tap **WI-FI**.
- On the home screen or list menu, tap **Settings**, and then tap **Wi-Fi** to turn it on or off.

Connect to a wireless network

1. On the home screen or list menu, tap **Settings**, and then tap **Wi-Fi** to turn it on.
2. Detected Wi-Fi networks will be listed in the Wi-Fi networks section.

3. Tap the desired Wi-Fi network you want to connect.
 - If you selected a secured network, you'll be asked to enter the network key or password.



The next time your tablet connects to a previously accessed secured wireless network, you won't be asked to enter the key or other security information again.

Forget the wireless network

Any network that has ever been used, including the current network, can be forgotten so your tablet will not automatically connect to it.

1. On the home screen or list menu, tap **Settings**, and then tap **Wi-Fi**.
2. Tap the wireless network you've been connected.
3. Tap **Forget**.

Use your tablet as a wireless router

Share your data connection with other devices by turning your tablet into a wireless router.



- Make sure the data connection is turned on.
- You must have an approved data plan associated with your account from your service provider to use this service.

1. On the home screen or list menu, tap **Settings**.
2. Tap **More...> Portable hotspot**.
3. Tap **Set up Wi-Fi hotspot**, choose the default router name.
4. Choose the type of security and set the password (key) for your wireless router.
 - If you selected **Open** in Security, you don't need to enter a password. The password is the key other people need to enter on their device so they can connect and use your tablet as a wireless router.
5. Tap to turn on Wi-Fi hotspot.

VPN

You can connect and access resources inside a secured local network, such as your corporate network. Depending on the type of VPN you're using at work, you may be asked to enter your login credentials and install security certificates before you can connect to your company's local network. You can get this information from your network administrator. You must first establish a Wi-Fi before you can start a VPN connection.

Add a VPN connection

You must first set a lock screen PIN or password before you can use credential storage and set up the VPN.

1. On the home screen or list menu, tap **Settings**.
2. Tap **More... > VPN**.
3. Tap  to add VPN profile.
4. Enter the VPN settings and set them up according to the security details your network administrator gave you.
5. Tap **Save**.

Connect to a VPN

1. On the home screen or list menu, tap **Settings**.
2. Tap **More... > VPN**.
3. Tap the VPN that you want to connect to.
4. Enter your log in credentials, and then tap **Connect**. When you're connected, the VPN

connected icon appears in the notification area of the status bar. You can then open the web browser to access resources such as your corporate network intranet.









Disconnect from a VPN

1. On the home screen or list menu, tap **Settings**.
2. Tap **More... > VPN**.
3. Tap the VPN connection to disconnect from it.

Web browse

You can use your tablet to browse the websites. Before browsing a website, please confirm that you have turn on data connection or Wi-Fi.

Browse a webpage

1. On the home screen or list menu, tap **Browser**.
2. Enter your search keywords or a webpage address.
3. While browse a webpage, you can:
 - Tap  to go to the previous webpage.
 - Tap  to go to the next webpage.
 - Tap  to reload the current web page; while the device is loading web pages, this icon changes to .
 - Tap  to bookmark the current web page.
 - Tap  to search for information.
 - Tap  to browse webpages from Bookmarks, History and Saved pages.
 - Tap  to close the current tab.
 - Tap  to open a new tab.

Add bookmarks

1. On the home screen or list menu, tap **Browser**.
2. Enter your search keywords or a webpage address.
3. Browse a webpage.
4. Tap .

Open a bookmark

1. While viewing a webpage, tap .
2. Tap **Bookmarks**.
3. On the Bookmarks tab, tap the bookmark you want to open.

Edit a bookmark

1. While viewing a webpage, tap .
2. Tap **Bookmarks**.
3. On the Bookmarks tab, tap and hold the webpage you want to edit.
4. Tap **Edit bookmark** on the pop up screen.
5. Enter your changes, and then tap **OK**.

View Browsing history

1. While viewing a webpage, tap .
2. Tap **History**.
3. On the History tab, view your Internet history today or most visited websites.

Download files

You can download files and apps directly from your favorite websites.



Files and apps downloaded from the Web can be from unknown sources. To protect your tablet and personal data, we strongly recommend that you download and open only the files you trust.

1. On the home screen or list menu, tap **Browser**.
2. Go to the website where you can download the file you want.
3. Follow the website's download instructions for apps.



Before you can install the downloaded app, you need to set your tablet to allow installation of third-party apps in **System settings > Security > Unknown sources**.

View your downloads

1. On the list menu, tap **Downloads**.
2. Tap the file to open it.

Browser settings

Customize the web browser to suit your browsing style. Set display, privacy, and security options when using the web browser.

- From the browser screen, tap  > **Settings**.

Set homepage

1. On the home screen or list menu, tap **Browser**.
2. On the browser screen, tap  > **Settings**.
3. Tap **General > Set homepage**.
4. Select the homepage you want to use.

5. Apps

5

Play store



Use the Google Play store to purchase and download applications and games that are able to run on your tablet. Choose from a wide variety of free and paid apps ranging from productivity apps, entertainment, to games.

- On the home screen or list menu, tap .



- A Google Wallet™ payment service is required to purchase a paid app. You will be asked to confirm method of payment when you purchase an app.
- The name of the Play Store app may differ depending on your region.
- The ability to purchase apps varies by region.



Search and install an app

1. On the home screen or list menu, tap .
2. Browse applications by category, or tap  to search with a keyword.
3. Select an application to view information.
4. To download it, tap **Install**.
 - If there is a charge for the application, tap the price, and follow on-screen instructions to complete the purchase process.



- When a new version is available for any installed application, an update icon appears at the bottom of the screen to alert you to the update. Open the notifications panel and tap the icon to update the application.
- To install applications that you downloaded from other sources, you need to set your tablet to allow installation of third-party apps in **System settings > Security > Unknown sources**.

Uninstall an app in Play store

1. On the home screen or list menu, tap .
2. Tap .
3. Select an app you want to uninstall.
4. Tap **Uninstall**.

Manage your apps

Check the running apps

1. On the home screen or list menu, tap **Settings > Apps**.
2. Go to Running tab, you can check all the apps running now.

Stop an app

1. On the home screen or list menu, tap **Settings > Apps**.
2. Tap the app you want to stop.
3. Tap **Stop**.

Uninstall an app

1. On the home screen or list menu, tap **Settings > Apps**.
2. Tap the app you want to uninstall.
3. Tap **Uninstall**.



- For different apps, the options may be vary.
- You can not uninstall the essential apps and system app, such as Installer Prestigio, Settings and etc.

6. Mail

6

Use this application to send or view email messages. Learn to send or view email messages via your personal or company email account.

Set up an email account

1. On the home screen or list menu, tap **Email**, do one of the following:
 - If this is your first time to add an email account in Mail, just move to the next step.
 - If you've already added an email account in Mail, then tap  > **Settings** > **ADD ACCOUNT**.
2. Enter the email address and password for your email account.
3. Tap **Next** for a private email account, or tap **Manual setup** for a company email account.
4. Follow on-screen instructions to complete the setup.





When you are finished setting up the email account, the email messages are downloaded to your device.



Consult your mail service provider for the mail server configuration.

Send a mail

1. On the home screen or list menu, tap **Email**.
2. Switch to the email account that you want to use.
3. Tap .
4. Fill in one or more recipients.
 - If you want to loop in more recipients in a carbon copy (Cc) or blind carbon copy (Bcc) of the email message, tap **+CC/BCC**.
5. Enter the subject, and then compose your mail.
 - Add an attachment: tap  and then choose what you want.
6. Tap  to send the mail.

View your mails

1. On the home screen or list menu, tap **Email**.
2. Switch to the email account that you want to use.
3. The mail inbox displayed on the screen.
4. Tap  to check whether there is a new mail.
5. Tap the desired mail to read it.



Unread email messages display in bold in your inbox and color bars appear next to them.

Search for a mail

1. On the home screen or list menu, tap **Email**.
2. Switch to the email account that you want to use.
3. Tap  to display the search bar.
4. Choose a search option in the drop-down list.
5. Enter the first few letters of the mail sender or subject in the search bar.
6. Select the mail from the list.

Reply to a mail

1. On the home screen or list menu, tap **Email**.
2. Switch to the email account that you want to use.
3. In the email account inbox, tap the email message.
4. Tap ↩, and then compose your mail.
5. Tap ➤ to send the mail.

Delete mails

1. On the home screen or list menu, tap **Email**.
2. Switch to the email account that you want to use.
3. Tap the desired mail, and then tap 🗑.

Gmail

Use this application to quickly and directly access the Google Mail service.

View your Gmail Inbox

All your received email messages are delivered to your Inbox.

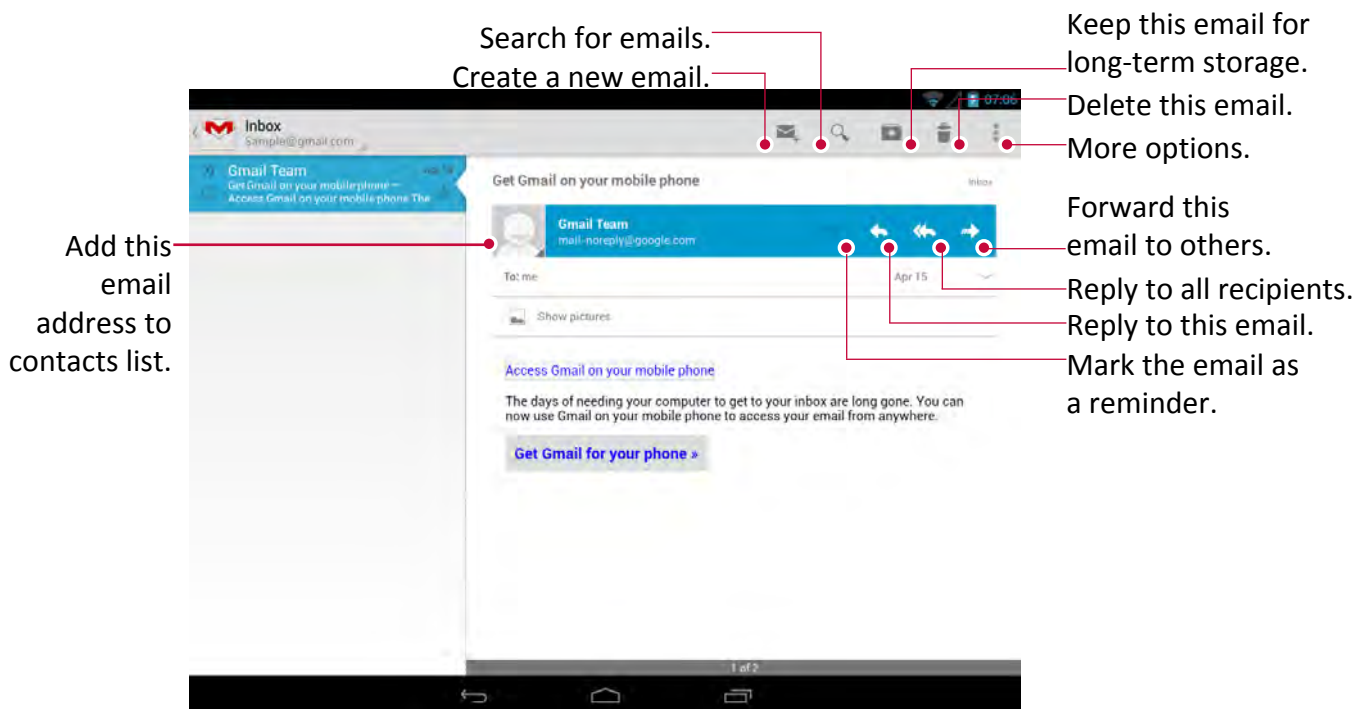

1. On the home screen or list menu, tap **Gmail**.
2. The mail inbox displayed on the screen.
3. Tap ↻ to check whether there is a new mail.
4. Tap the desired mail to read it.
5. Swipe left or right to view the previous or next mail.





Search for a mail

1. On the home screen or list menu, tap **Gmail**.
2. Tap 🔍 to display the search bar.
3. Enter the first few letters of the mail sender or subject in the search bar.
4. Select the mail from the list.

Send a mail by Gmail

1. On the home screen or list menu, tap **Gmail**.
2. Tap .
3. Fill in one or more recipients.
 - If you want to loop in more recipients in a carbon copy (Cc) or blind carbon copy (Bcc) of the email message, tap **+CC/BCC**.
4. Enter the subject, and then compose your mail.
 - Add a picture or video: tap .
5. Tap  to send the mail.

Reply to a mail by Gmail

1. On the home screen or list menu, tap **Gmail**.
2. In the email account inbox, tap the email message.
3. Tap , and then compose your mail.
4. Tap  to send the mail.

Delete mail by Gmail

1. On the home screen or list menu, tap **Gmail**.
2. Tap the desired mail, and then tap .

7. Camera

7

With your tablet, you can take both photos and videos as desired. In addition to the rear camera on the back, there's a camera on the front for video calls and self-portraits. The LED flash on the back gives you extra light when you need it.

- To use the camera, on the home screen or list menu, tap **Camera**.

Your camera at a glance

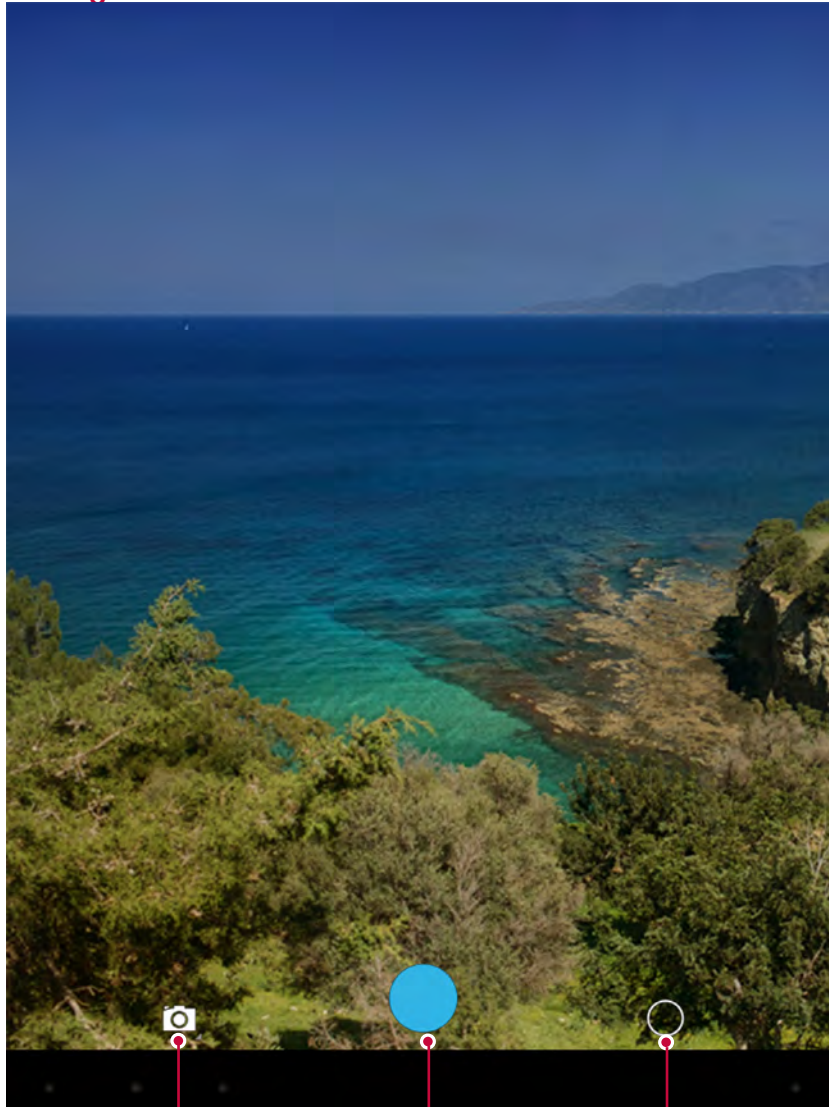

Tap to select capture mode.

Capture a photo.

Tap to switch cameras and change settings.

Select capture mode

While using your camera, you can select your desired capture mode. You can choose the following capture modes:



Take a single photo.



Record a video.





Take a panoramic photo. You can take a photo composed of many photos strung together.

Take a photo



1. Tap **Camera** to turn on the camera.
2. Spread or pinch the screen to zoom in or out.
3. Change the camera setting if necessary.
4. Just point the camera at what you want to capture. The camera adjusts the focus automatically as you move it.
5. Tap  to capture the photo.

Take a photo of yourself



1. Tap **Camera** to turn on the camera.
2. On the screen, tap  > .
3. Tap  to capture the photo.

Take a panoramic photo

You can capture anything wide or tall in a single photo by using your tablet.



1. Tap **Camera** to turn on the camera.
2. Tap , and then tap .
3. When you're ready to take the first shot, tap . Directional arrows appear, prompting you to pan left or right in landscape view (or pan up or down in portrait view).
4. Pan your tablet as smoothly as you can, and then pause when you see a complete frame on the Viewfinder screen. The camera automatically captures the shot.
5. Repeat the previous step to take the remaining shots.
6. The camera stitches the shots into a single photo.

Record a video

1. Tap **Camera** to turn on the camera.
2. Tap , and then tap .
3. While recording, use the following actions:
 - Freely zoom in or out.
 - To capture an image from the video while recording, just tap the screen.
4. To stop recording, tap .





Camera scenes

A scene is a collection of settings to suit the lighting and environment. Use Normal and let the camera automatically determine optimal settings, or choose from a wide selection of scenes before you start taking photos. Predefined settings make point-and-shoot photos easier to take.

1. Tap **Camera** to turn on the camera.
2. Choose , and then tap  >  > **Scene mode**.

Camera settings

Before taking photos/recording videos, customise your camera settings.

1. Tap **Camera** to turn on the camera.
2. Choose / , and then tap  >  to customize your camera.
 - **Scene mode:** Change the scene mode.
 - **Store location:** Store the picture taking location or not.
 - **Picture size:** Select the size of picture.
 - **Time lapse:** Turn it on to set time interval.

8. Multimedia

8

Your tablet provides you several entertainment ways. You can view the photos taken by the camera. You can also enjoy music and video playing.

Gallery

Use Gallery to view all your photos and videos that are on your tablet.

- To open your gallery, on the home screen or list menu, tap **Gallery**.



- Some file formats are not supported depending on the software installed on the device.
- Some files may not play properly depending on how they are encoded.

View your photos

View photos in the album

1. On the home screen or list menu, tap **Gallery**.
2. Tap  to open drop-down list, and then tap **Albums**.
3. Browse to an album or a group of photos.
4. Tap a photo to view it in full screen.

View photos by locations

1. On the home screen or list menu, tap **Gallery**.
2. Tap  to open drop-down list, and then tap **Locations**.
3. Pinch the screen or pan across the map until (location indicator) appears. The location indicator shows how many photos are taken in that area. Only photos with geo-tag info appear on the map.
4. Tap the location indicator. The photos taken in the same area are displayed.

View photos by time

View photos and videos based on when they were taken.

1. On the home screen or list menu, tap **Gallery**.
2. Tap  to open drop-down list, and then tap **Times**. Photos and videos stored on your tablet are displayed according to the time they were taken.
3. Tap the sorted photos by a time. All the photos taken around that time are displayed.

Zoom in and out

Use one of the following methods to zoom in an image:

- Double-tap anywhere to zoom in.
- Spread two fingers apart on any place to zoom in. Pinch to zoom out, or double-tap to return.

Start a photo slideshow

1. On the home screen or list menu, tap **Gallery**.
2. Browse to an album or a group of photos.
3. Tap  > **Slideshow**.

Watch a video

1. On the home screen or list menu, tap **Gallery**.
2. In the Gallery app's Album, go to the video that you want to watch.
3. Tap the on-screen controls to control the video playback.



4. Press the volume button to adjust the volume.
5. Tap  to select more options.

Edit your photos

When viewing a photo, tap  and use the following functions:

- **Delete:** Delete the photo.
- **Slideshow:** Start a slideshow with the images in the current folder.
- **Edit:** Launch Paper Artist to edit the photo.
- **Rotate left:** Rotate anticlockwise.
- **Rotate right:** Rotate clockwise.
- **Crop:** Resize the orange frame to crop and save the photo in it.
- **Set picture as:** Set the photo as a wallpaper or a contact image.
- **Details:** Check information of the photo.

Crop a photo



1. On the home screen or list menu, tap **Gallery**.
2. Browse to the photo that you want to edit.
3. Tap  > **Edit**, and then tap  > **Crop**. You'll see a crop box around the photo.
 - Drag the crop box over the part of the photo you want to crop.
 - Press the edge of the crop box, and drag your finger inward or outward to resize the crop box.
4. Tap **Save**.

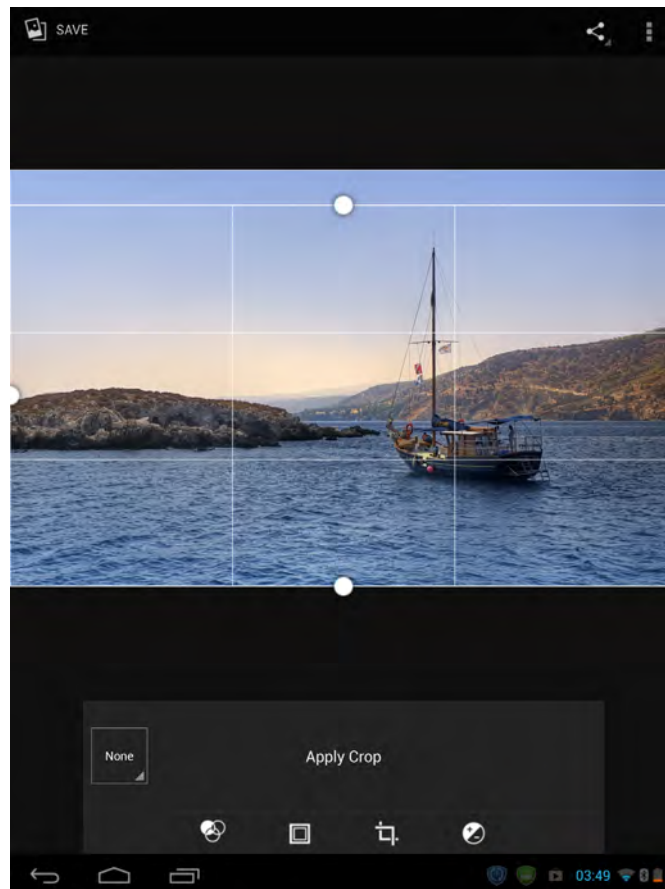

The cropped photo is saved as a copy. The original photo remains unedited.



Add photo effects

1. On the home screen or list menu, tap **Gallery**.
2. Browse to the photo that you want to edit.
3. Tap  > **Edit**, and then tap .
4. Tap an effect to apply to the photo.
5. Tap **Save**.





The enhanced photo is saved as a copy. The original photo remains unedited.

Share your photos

You can share your photos with another device via email, MMS or Bluetooth.



Share photos by Email

1. On the home screen or list menu, tap **Gallery**.
2. Browse to the photo that you want to share.
3. Tap  to open the drop-down list, and then tap **Email**.
4. Choose an Email account.
5. Compose your message.
6. Tap  to send the mail.



If you have multiple email accounts, the default email account will be used.

Share a photo by MMS

1. On the home screen or list menu, tap **Gallery**.
2. Browse to the photo that you want to share.
3. Tap  to open drop-down list, and then tap **Messaging**.
4. Enter a phone number or add a contact from your phonebook.
5. Compose your message.
6. Tap  to send the message.

Share photos via Bluetooth

1. On the home screen or list menu, tap **Gallery**.
2. Browse to the photo that you want to share.
3. Tap  to open drop-down list, and then tap **Bluetooth**.



You'll be asked to turn on Bluetooth and connect to the receiving Bluetooth device, so the files can be sent.

Delete photos

1. On the home screen or list menu, tap **Gallery**.
2. Browse to the photo that you want to delete.
3. Tap , and then tap **delete**.

Set as wallpaper or contact photo

1. On the home screen or list menu, tap **Gallery**.
2. Browse to the photo that you want to set as wallpaper.
3. Tap , and then tap **Set picture as**.
4. Select Wallpaper or Contact photo.
5. You'll see a crop box around the photo.
 - Drag the crop box over the part of the photo you want to crop.

- Press the edge of the crop box. When directional arrows appear, drag your finger inward or outward to resize the crop box.
6. Tap **OK** to set the photo as your wallpaper or contact photo.

Video player

You can use the video player on your tablet to watch the videos.



Watch a video by using video player

1. On the home screen or list menu, tap **Video**.
2. Tap the video that you want to watch.
3. Tap the on-screen controls to control the video playback.
4. Press the volume button to adjust the volume.
5. Tap  to select more options.

Share your videos

You can share your photos with another device via email, MMS or Bluetooth.



Share videos by Email

1. On the home screen or list menu, tap **Video**.
2. Tap the video that you want to share.
3. Tap  to open drop-down list, and then tap **Email**.
4. Choose an Email account.
5. Compose your message.
6. Tap  to send the mail.



If you have multiple email accounts, the default email account will be used.

Share a video by MMS

1. On the home screen or list menu, tap **Video**.
2. Tap the video that you want to share.
3. Tap  to open drop-down list, and then tap **Messaging**.
4. Enter a phone number or add a contact from your phonebook.
5. Compose your message.
6. Tap  to send the message.

Share videos via Bluetooth

1. On the home screen or list menu, tap **Video**.
2. Tap the video that you want to share.
3. Tap  to open drop-down list, and then tap **Bluetooth**.



You'll be asked to turn on Bluetooth and connect to the receiving Bluetooth device, so the files can be sent.

Music player

You can listen to your favourite music with the music player. The Music app is a central hub for your favorite music whether it is on your tablet or streamed through a music service.

- To use the music player, on the home screen or list menu, tap **Music**.



- Some file formats are not supported depending on the device's software version.
- Some files may not play properly depending on the encoding used.

Browse music

1. From the Home screen, tap **Music**.
2. You can:
 - Tap **Artists/Albums/Playlists**, you can browse songs sorted by artists, albums, or playlists.
 - Tap **Songs**, browse all songs.
 - Tap **Now playing**, check the song is playing now.

Listen to music

1. On the home screen or list menu, tap **Music**.
2. Tap a song from the category.
3. Use the following keys to control playback:

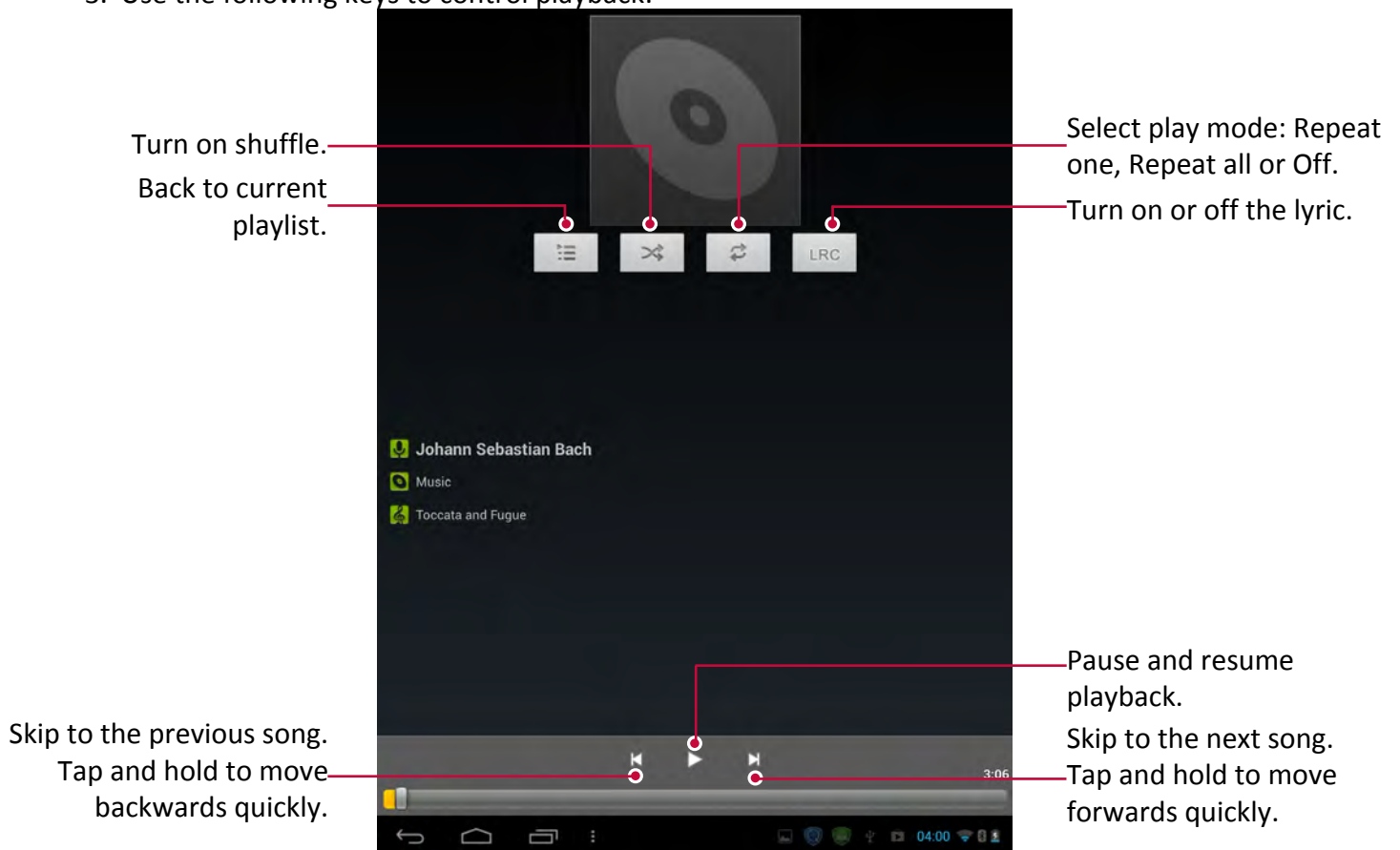

Set a song as ringtone

1. On the home screen or list menu, tap **Music**.
2. Tap a song from the category.
3. Tap  to select **Use as ringtone**.

Your playlist

Create a playlist

You can make your own playlist.

1. On the home screen or list menu, tap **Music**.
2. Tap a song from the category.
3. Tap  to select **Add to playlist**.
4. On the pop up screen, tap **New** to create a new playlist.
5. Enter a title and tap **Save**.

Rename the playlist

1. On the home screen or list menu, tap **Music**.
2. Tap **Playlists** to view all your playlists.
3. Tap and hold the playlist you want to rename.
4. Select **Rename** on the pop up screen.

Delete a playlist

1. On the home screen or list menu, tap **Music**.
2. Tap **Playlists** to view all your playlists.
3. Tap and hold the playlist you want to delete.
4. Select **Delete** on the pop up screen.



Delete a song

1. On the home screen or list menu, tap **Music**.
2. Tap a song from the category.
3. Tap  to select **Delete**.

Sound recorder

Use Sound Recorder to capture information during lectures, interviews, or even to create your own audio log.

Record a voice memo

1. On the home screen or list menu, tap **Sound Recorder**.
2. Hold the microphone near the sound source.
3. Tap  to start recording a voice clip.
4. Tap  to stop recording.
5. Tap **Save**.





Sound Recorder can run in the background while you do other things on your tablet, except when you open other apps that also use audio functions.

Play a voice memo

1. On the home screen or list menu, tap **Sound Recorder**.
2. Tap  to open recording file list.
3. Select your voice memo and tap it.

Delete a voice memo

1. On the home screen or list menu, tap **Sound Recorder**.
2. Tap  to open recording file list.
3. Tap and hold the voice memo you want to delete.
4. Tap  to delete the file.

9. Bluetooth

9

Your tablet can connect to a compatible Bluetooth device for exchanging data. Bluetooth creates a direct wireless connection between two devices over short distances.



Do not use the Bluetooth feature for illegal purposes (for example, pirating copies of files or illegally tapping communications for commercial purposes).

Turn on or off Bluetooth

1. On the home screen or list menu, tap **Settings**.
2. Tap to turn on or off **Bluetooth**.

Pair with a Bluetooth device

1. On the home screen or list menu, tap **Settings**.
2. Tap to turn on or off **Bluetooth**.
3. A list of available Bluetooth devices appears.
4. Select the device you wish to connect.
5. Tap **Pair**. The pairing is made if your pairing request is accepted by the other part.

Unpair with a Bluetooth device

1. On the home screen or list menu, tap **Settings**.
2. Tap **Bluetooth**.
3. Select the device you want to unpair and then tap
4. Tap **Unpair**.

Send data via Bluetooth

1. On the home screen or list menu, tap **Settings**.
2. Tap to turn on or off **Bluetooth**.
3. Pair with a Bluetooth device.
4. Tap **Explorer** on the home screen or list menu.
5. Tap the file you want to share.
6. Tap and select Bluetooth.
7. Select a device to start sending the file.

Receive data via Bluetooth

1. On the home screen or list menu, tap **Settings**.
2. Tap to turn on or off **Bluetooth**.
3. Tap your tablet model to make it visible to all nearby Bluetooth devices.
4. Accept the request and pair with the other Bluetooth device.
5. Slide to open notifications panel, tap **Accept**.



- If you do not use the Bluetooth feature for some time, you should deactivate it in order to conserve battery power.
- The files received via Bluetooth are stored in the Bluetooth folder.

10. eReader Prestigio

10

With the eReader Prestigio, you can easily and quickly download and read eBooks on your tablet.

- On the home screen or list menu, tap **eReader Prestigio**.

Your eReader at a glance

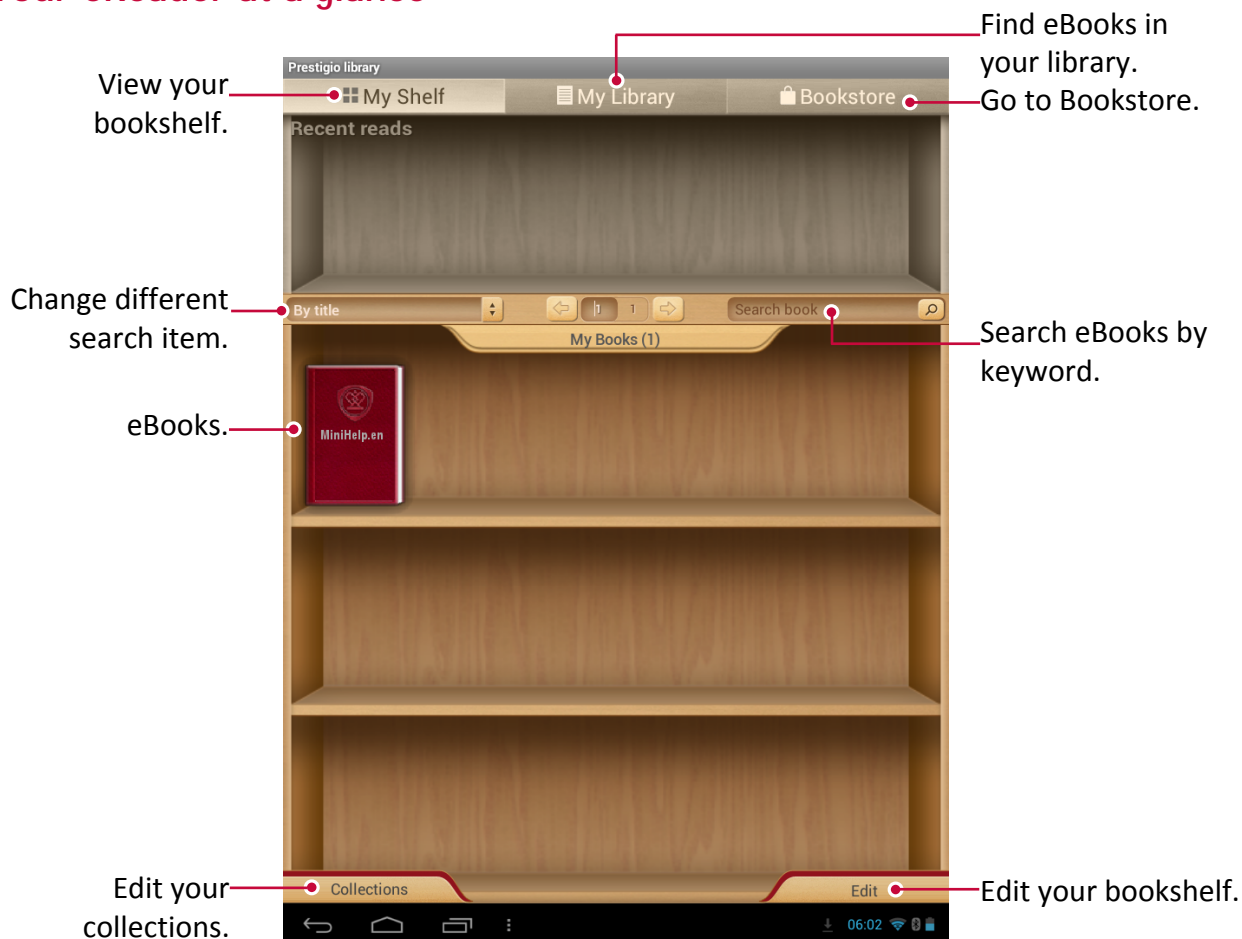

Download an eBook

You can download eBooks by using eReader Prestigio. Some eBooks are free to download, and some eBooks need a payment.





You will be asked to confirm method of payment when you purchase a paid eBook.

1. On the home screen or list menu, tap **eReader Prestigio**.
2. Tap **Bookstore** tab.
3. Select your language, and then find your desired eBook.
4. Tap  to download the eBook.

Read an eBook



1. On the home screen or list menu, tap **eReader Prestigio**.
2. Tap **My shelf** or **My library** tab.
3. Find your desired eBook.
4. Tap the eBook to read it.

Add a bookmark

1. While reading an eBook, tap .
2. Tap , and then tap **New bookmark**.
3. The certain page is added to bookmark.



Open the bookmark

You can continue reading your eBook from the certain page which you have added to bookmark.

1. While reading an eBook, tap .
2. Tap .
3. In **This book** or **All books** tab, tap your desired bookmark.



Search for a content

You can search for certain content in the eBook, for example, a word, a sentence or a paragraph, etc.

1. While reading an eBook, tap .
2. Tap .
3. Enter a word, a sentence or a paragraph, etc.
4. Tap **Go** in the virtual keyboard to search for the content page by page.

Zoom in and out

While reading an eBook, you can zoom in or out the screen to fit your reading.

1. While reading an eBook, tap .
2. Tap .
3. Tap **Zoom in** or **Zoom out**.

eReader settings

You can set up your eReader Prestigio while reading an eBook.

1. On the home screen or list menu, tap **eReader Prestigio**.
2. Tap **My shelf** or **My library** tab.
3. Find your desired eBook.
4. Tap the eBook to read it.
5. While reading an eBook, tap .
6. Tap **Settings**.
7. Select your desired options.

11. Travel & maps

Use this application to pinpoint the location of your tablet, search for places, or get directions.

11

Find a location

About Locations

Use this application to search for nearby restaurants, banks, bus stops, and more.

- On the home screen or list menu, tap **Local**.



- If you are in an area where there are a lot of surrounding buildings, locations may have a hard time pinpointing your location.
- This application may not be available depending on the region or service provider.

Turn on or off location service

In order to find your location on your tablet, you need to enable location sources.



1. On the home screen or list menu, tap **Settings**.
2. Tap **Location access**.
3. Turn on **Access to my location**.

Find your location

1. On the home screen or list menu, tap **Local**.
2. Your tablet will pinpoint your location.
3. Select a category that you're interested in to see the places that are nearby.



Add a new category

You can add a new category to search for more places nearby quickly.

1. On the home screen or list menu, tap .
2. Tap  > **Add a search**.
3. On the category list, enter a keyword to search into the text field.

Search for a place



You can search for a name of an establishment, street, or city. Suggested matches will be shown while you type.

1. On the home screen or list menu, tap **Local**.
2. Tap .
3. Enter the place you want to search for.
4. Select the desired place in the result list.
 - Tap  to get directions to the place.

Get directions

Get detailed directions to where you want to go.

Get directions from your location

1. On the home screen or list menu, tap **Local**.
2. Tap .
3. Enter the place you want to search for.
4. Select the desired place in the result list.
5. Tap  to get directions to the place.

6. Choose how you want to get to your destination.
7. The map opens showing the route to your destination.

Get directions by setting a start and end location

1. On the home screen or list menu, tap **Local**.
 - Or, tap **Maps** on the home screen or list menu.
2. Tap  to get directions.
3. Choose your start point and end point.
4. The map opens showing the route to your destination.

Use Google maps

About Google Maps

Google Maps lets you track your current location and receive detailed directions to your destination. It also provides a search tool where you can locate places of interest or an address on a map, or view locations at street level.



- On the home screen or list menu, tap **Maps**.





- To find your location with Google Maps, you need to enable location sources.
- The Google Maps app does not cover every country or city.

Use Google maps

You can do the following:

- Tap  to search for a place.
- Tap  to get directions.
- Tap  to find your location on the map.

Get help

If you need help or have questions about Maps or Latitude, tap  > **Help** (or  > **Latitude**).

Maps settings

You can set up the Google maps, tap  > **Settings** while viewing the maps.

12. My files and storage

12

My files

Use this application to access all kinds of files stored on your tablet, including photos, videos, songs, and sound clips.

- On the home screen or list menu, tap **Explorer**.

View my files

1. On the home screen or list menu, tap **Explorer**.
2. Tap to choose a source storage.
3. Select a folder to open it.

Add a new folder

1. While viewing a folder or file, tap **New Folder** on the top.
2. Enter a name for the new folder.
3. Tap **OK** to add the folder to the file list.

Manage your files and folders

While viewing a folder, tap and hold the file or folder, you can share, copy, move or delete a file or a folder.

Storage

If you connect a Micro SD card to your tablet, there are two source storages: your tablet and the Micro SD card.

Check your storage usage

1. On the home screen or list menu, tap **Settings**.
2. Tap **Storage**.
3. You can check the total space of your tablet's memory and SD card.

Erase SD card

1. On the home screen or list menu, tap **Settings**.
2. Tap **Storage**.
3. Select **Erase SD card**.



Formatting a memory card permanently deletes all data from it.



The actual available capacity of the internal memory is less than the specified capacity, because the operating system and default applications occupy part of the memory.

13. Utilities

13

Clock

Use the clock app to set alarms, check the time in any location in the world, measure the duration of an event, or set a timer.

- On the home screen or list menu, tap **Clock**.

World clock



You can add a city to the world clock screen.

1. On the home screen or list menu, tap **Clock**.
2. Tap .
3. Scroll through the list and tap the city that you want to add.

Alarm

You can set up one or more alarms.

Set an alarm



1. On the clock screen, tap .
2. Tap  to add a new alarm.
3. Use the virtual digit keyboard to set the alarm time.
4. Tap **OK**.
5. If you want the alarm for multiple days, tap **Repeat**.

Turn off an alarm



1. On the clock screen, tap .
2. Select the alarm you want to turn off.
3. Drag the check button to Off.

Stop an alarm

When the alarm rings,

- Slide to : The alarm stops.
- Slide to : The alarm will sound again after a specified length of time.



Delete an alarm

1. On the clock screen, tap .
2. Tap and hold the alarm you want to delete.
3. Tap .

Timer

1. On the clock screen, tap .
2. Set the duration, and then tap **Start**.

Stopwatch

- On the clock screen, tap 
 - Tap **Start** to time an event.
 - Tap  to record lap times.
 - Tap  to clear lap time records.

Calendar

You can create your event and make a plan on your calendar.

- On the home screen or list menu, tap **Calendar**.

View the calendar

On the home screen or list menu, tap **Calendar** to check the calendar. Tap  to change your calendar to Day, Week, Month or Agenda view.



Create an event

1. Go to **Calendar**, select a date.
2. Tap  to create a new event.
3. Edit reminder settings.
4. Tap **Done** to save the event.

Manage your events

Edit an event



You can only edit events you have created.

1. While viewing the calendar, tap  to change your calendar to Agenda view.
2. Tap the event you want to edit, and then tap .
3. Make your changes to the event.
4. Tap **Done**.



If you're editing an event that repeats, you'll be asked whether you want to edit just that occurrence or all occurrences of that event.

Delete an event

1. While viewing the calendar, tap  to change your calendar to Agenda view.
2. Tap the event you want to delete, and then tap .



If the event repeats, you'll be asked whether you want to delete just that occurrence or all occurrences from Calendar.

Calculator

Use this app for simple or complex calculations.

On the home screen or list menu, tap **Calculator**.

- To clear history, tap **CLR**.

Google search

Use this application to search not only the Internet, but also apps and their contents on your tablet as well.

- On the home screen or list menu, tap **Google**.



Some apps, such as Contacts or Emails, have their own search function, which you can use to search only within those apps.

Search on the web or your tablet

1. Tap the search field, and then enter a keyword.
2. Select one of the suggested keywords that appear.



If no results are returned from the apps, the web browser appears, displaying the search results.

Search with your voice

Use Google Voice Search to find information on the Web just by speaking to your tablet.

1. On the home screen or list menu, tap **Voice Search**.
 - If the Google search bar is available on the Home screen, you can also tap .
2. Speak a keyword or phrase when **Speak now** appears on the screen.
3. Select one of the suggested keywords that appear.
4. If what you're searching for is in the list, tap the item to open it in its compatible app. Otherwise, tap **Retry** to search again.



This application may not be available depending on the region or service provider.

14. Set up your tablet

14

Use this app to control and customize tablet settings.

- On the home screen or list menu, tap **Settings**.

Wireless & Networks

Wi-Fi

Activate the Wi-Fi feature to connect to a Wi-Fi network and access the Internet or other network devices.

Bluetooth

Activate the Bluetooth feature to exchange information over short distances.

Data usage

Keep track of your data usage amount, and customise the settings for the limitation.

More...

Set up the following items.

- **Airplane mode**

Activate Flight mode to disable all wireless functions on your device. You can use only nonnetwork features.

Airplane mode disables the wireless features in order to reduce potential interference with aircraft operation and other electrical equipment.

- **VPN**

Set up and manage virtual private networks (VPNs).

- **Portable hotspot**

- Set to use your device as a wireless access point for other devices.

- **Mobile networks**

- Data enabled: Use to allow packet switching data networks for network services.
- Data roaming: Use the device to connect to another network when you are roaming or your home network is not available.
- Use only 2G networks to save battery.
- Access Point Names: Set up access point names (APNs).
- Network operators: Search for available networks and select a network for roaming.

Device

Sound

- Turn on or off system sound.
- Set the volume for media files, ringtone and notification.

Display

Change the settings to control the display and backlight on your device.

HDMI

Turn on HDMI and connect HDMI cable to show tablet screen on TV. You can adjust output resolution, zoom in or out screen, and set screen timeout.

Screenshot

Set up screenshot capture, storage, and display.

Storage

View memory information for your device and memory card. You can also format the memory card.



Formatting a memory card permanently deletes all data from it.



The actual available capacity of the internal memory is less than the specified capacity because the operating system and default applications occupy part of the memory.

Battery

View the amount of battery power consumed by your device.

Apps

Manage running applications, move applications to or from the storage card, and install or uninstall programs.

Users

Set up tablet users' information.

Personal

Location access

Select the sources to use when determining your location.

- Access to my location: Set to use Wi-Fi and/or mobile networks for finding the current location.
- GPS satellites: Set to use the GPS satellite for finding the current location.
- Wi-Fi & mobile network location: Let apps use Google's location service to estimate your location faster.

Security

Set a screen lock or manage the credential storage.

Language & input

Set the operating system language and region. You can also set on-screen keyboard options.

Backup & reset

Change the settings for managing settings and data.

- Back up my data: Set to back up settings and application data to the Google server.
- Backup account: Set up or edit your Google backup account.
- Automatic restore: Set to restore settings and application data when the applications are reinstalled on the device.
- Factory data reset: Reset settings to the factory default values and delete all data.

Accounts

Add and manage your Email, Google, Facebook and Twitter accounts.

System

Date & time

Access and alter the following settings to control how the device displays the time and date.

- Automatic date & time: Automatically update the time and date when moving across time

zones.

- Automatic time zone: Set to receive time zone information from the network when you move across time zones.
- Set date: Set the current date manually.
- Set time: Set the current time manually.
- Select time zone: Set the home time zone.
- Use 24-hour format: Display time in 24-hour format.
- Choose date format: Select a date format.

Accessibility

Use these settings when you've downloaded and installed an accessibility tool, such as a screen reader that provides voice feedback. You can turn accessibility functions or services on or off.

Developer options

Change the settings for application development.

About tablet

Access device information and update device software. View different information about the tablet, such as the battery, legal information, model number, software version, baseband version and build number.

15. Specifications

15

Item	Specification
Processor	Quad core cortex-A9
Memory	16GB eMMC+2GB DDR3, Micro SD slot supports up to 32GB
OS	Android 4.2
Frequency	1.6GHz
GPU	Mali 400 MP, 533 MHz
Display	9.7" Ratio 16:10 IPS, Capacitive multi-touch panel (support up to 5 points)
Resolution	2048*1536 Pixels
Interfaces	Micro USB 2.0, Micro SD (micro SDHC compatible)
Communications	WiFi (802.11 b/g/n)
Bluetooth	Support Bluetooth 4.0
Camera	Front 2MP, Rear 5MP
G-sensor	Support
HDMI interface	HDMI 1.4
Supported multimedia	Video playback, Audio playback, Picture, eBook
Dimension	241.5*185*9.3mm
Weight	626g

16. Troubleshooting

16

The tablet does not switch on

Remove/reinstall the battery. Then charge the tablet until the battery icon stops scrolling. Unplug the charger and try to switch the tablet on.

The network symbol is not displayed

The network connection is lost. Either you are in a radio shadow (in a tunnel or between tall buildings) or you are outside the network coverage area. Try from another place, try to reconnect to the network (especially when abroad), or contact your network operator for assistance/information.

The touch screen responds slowly or improperly

If your device has a touch screen and the touch screen is not responding properly, try the following:

- Remove any protective covers from the touch screen. Protective covers may prevent the device from recognising your inputs and are not recommended for touch screen devices.
- Ensure that your hands are clean and dry when tapping the touch screen.
- Restart your device to clear any temporary software bugs.
- Ensure that your device software is upgraded to the latest version.
- If the touch screen is scratched or damaged, take it to your local dealer.

Your battery seems to over heat

You might be using a charger that was not intended for use with your tablet. Make sure you always use the authentic accessory shipped with your tablet.

You can't receive and/or store JPEG pictures

A picture may not be accepted by your tablet if it is too large, if its name is too long, or if it doesn't have the correct file format.

When charging, the battery icon shows no bar and the outline is flashing

Only charge the battery in an environment where the temperature does not go below 0°C (32°F) or above 45°C (113°F). In other cases please contact your tablet supplier.

Your tablet doesn't work well in your car

A car contains many metallic parts that absorb electromagnetic waves which can affect the tablet's performance. A car kit is available to provide you with an external antenna and enables you to make and receive phone calls without handling the handset.

Check with the local authorities whether or not you are allowed to use the tablet while driving.

Your tablet is not charging

If the battery is completely flat, it might take several minutes of precharge (up to 5 minutes in some cases) before the charging icon is displayed on the screen.

The picture captured with the tablet camera is not clear

Make sure that the camera lens on both sides is clean.

Your device freezes or has fatal errors

If your device freezes or hangs, you may need to close programs or reset the device to regain functionality. If your device is frozen and unresponsive, press and hold the Power button for 8-10 seconds. The device reboots automatically.

If this does not solve the problem, perform a factory data reset. On the list menu, tap Settings > Back up & reset > Factory data reset > Reset device > Erase everything.

Another Bluetooth device is not located

- Ensure that the Bluetooth wireless feature is activated on your device.
- Ensure that the Bluetooth wireless feature is activated on the device you wish to connect to, if necessary.
- Ensure that your device and the other Bluetooth device are within the maximum Bluetooth range (10 m).

A connection is not established when you connect the device to a computer

- Ensure that the USB cable you are using is compatible with your device.
- Ensure that you have the proper drivers installed and updated on your computer.
- If you are a Windows XP user, ensure that you have Windows XP Service Pack 3 or higher installed on your computer.
- Ensure that you have Windows Media Player 10 or higher installed on your computer.