

acer
explore beyond limits™

Iconia One 7



Sign up for an Acer ID and enable Acer Remote Files

Open the Acer Portal from the Home screen to sign up for an Acer ID or sign in if you already have an Acer ID.

There are three great reasons for you to get an Acer ID:

- Remotely access your PC from your other devices with our free Acer Remote Files app
- Get the latest offers and product information
- Register your device for warranty service



For more information, please visit the AcerCloud website: www.acer.com/acercloud



Important

This manual contains proprietary information that is protected by copyright laws. The information contained in this manual is subject to change without notice. Images provided herein are for reference only and may contain information or features that do not apply to your computer. Acer Group shall not be liable for technical or editorial errors or omissions contained in this manual.

Acer Iconia B1-730 / B1-730HD

Model number: _____

Serial number: _____

Date of purchase: _____

Place of purchase: _____

TABLE OF CONTENTS

Getting started with your tablet	4	Google services	24
Features and functions	4	Playing music	29
Unpacking your tablet.....	4	Multimedia playback	29
Getting to know your tablet.....	5	Managing people and contacts	30
Using your tablet	7	Using the camera and camcorder	33
Charging your tablet	7	Camera/camcorder icons and indicators	33
Turning on for the first time.....	9	Settings	35
Using the touchscreen.....	10	Taking a photo	35
The Home screen	10	Shooting a video	36
The onscreen keyboard.....	16	Advanced settings	37
Editing text.....	17	Wireless & Networks.....	37
Shutting down your tablet.....	19	Device	39
Connecting devices to your tablet	20	Personal.....	40
Connecting to AC power.....	20	System.....	41
Inserting a microSD card	20	Updating your tablet's operating system	42
Transferring files between your tablet and a PC.....	20	Resetting your tablet.....	42
Connecting a Bluetooth device.....	21	FAQ and troubleshooting	43
Accessories	21	Other sources of help	45
Going online	22	Specifications	46
Managing Wi-Fi connections	22	End user license agreement	49
Browsing the Internet.....	22		
Setting up the Email application	23		

GETTING STARTED WITH YOUR TABLET

Features and functions

Your new tablet offers leading, easy-to-access multimedia and entertainment features. You can:

- Connect to the Internet via Wi-Fi.
- Access your email while on the move.
- Keep in touch with your friends via your People and social networking applications.

Unpacking your tablet

Your new tablet comes packed in a protective box. Carefully unpack the box and remove the contents. If any of the following items are missing or damaged, contact your dealer immediately:

- Acer Iconia B1-730 / B1-730HD tablet
- Product setup and safety information
- USB cable
- AC adapter
- Warranty card

Getting to know your tablet

Views

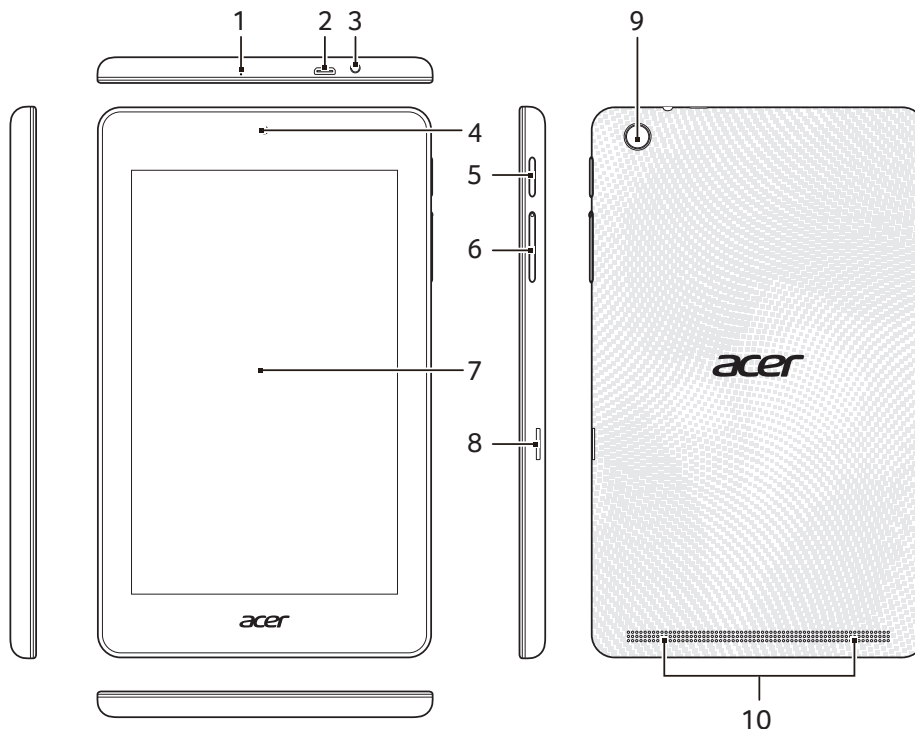

No.	Item	Description
1	Microphone	Receives audio for video chats and Internet calls.
2	Micro USB port (Slave)	Connects to a computer via a USB cable. Also serves as the charging port for the AC adapter. For more information, see Charging your tablet on page 7 .
3	3.5 mm headphone jack	Connects to stereo headphones.
4	Front-facing camera	A 0.3-megapixel camera for video chats and self-portrait images.
5	Power button	Long press to turn the tablet on, press briefly to turn the screen on/off or enter sleep mode; press and hold to turn the tablet off.
6	Volume control key	Increases and decreases the tablet volume.

No.	Item	Description
7	Touchscreen	7", 1280 x 800 pixel capacitive touchscreen.
8	microSD card slot	Insert a microSD card into the slot.
9	Rear-facing camera	A 2-megapixel camera for taking high-resolution images.
10	Speakers	Emit audio.

USING YOUR TABLET

Charging your tablet

For first-time use, you need to charge your tablet for four hours. After that you can recharge the battery as needed.

Assembling the power adapter

Your tablet is bundled with one of two types of USB power adapters: a fixed-prong type or a removable-prong type. Both types are described in this manual.

Fixed-prong type

The prongs and power adapter body form a complete piece, no assembly required. Simply slide the large end of the USB cable into the power adapter body (it will fit in only one direction). You cannot remove or switch the prongs with this type of adapter.

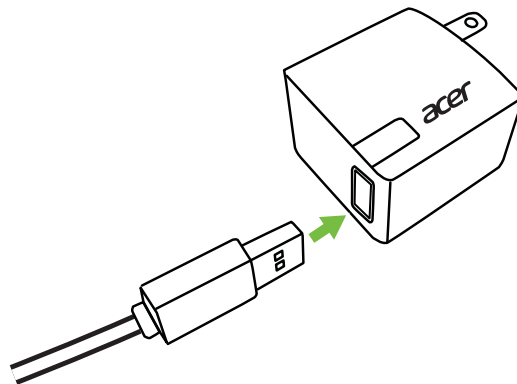

Removable-prong type

Align arrows on the power adapter head and body. Insert the head onto the power adapter body and turn the head towards "CLOSE" printed on the head until it clicks into place. Simply slide the large end

of the USB cable into the power adapter body (it will fit in only one direction).

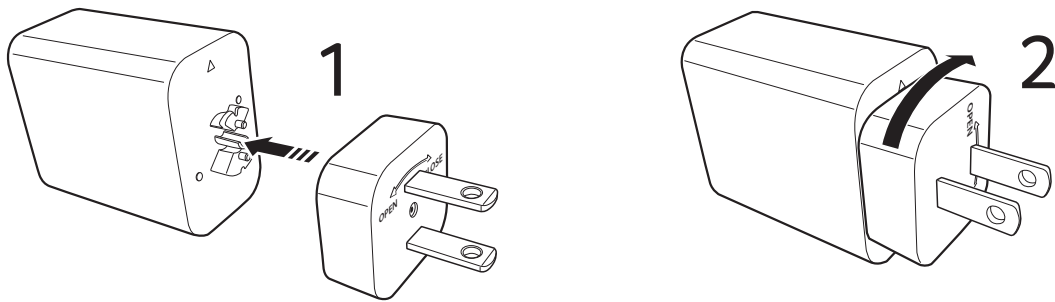

Connecting power

Connect the power connector to your tablet and plug the AC adapter into any AC outlet.

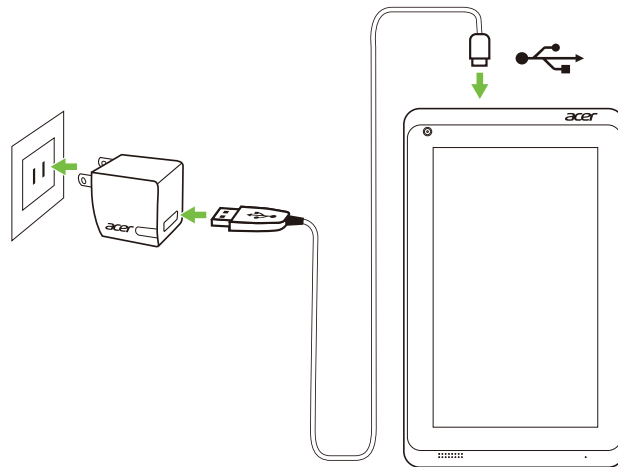

Warning

Only use the bundled power adapter to charge your device.



Note

It is normal for the tablet surface to become warm during charging or long periods of use.

Turning on for the first time

To turn on your tablet, press and hold the power button until you see the Acer logo. Wait a moment for your tablet to boot up. You will then be asked some questions before you can use your tablet.

To start, tap to select your language then tap **Start**. Follow the rest of the instructions as they are displayed.



If the tablet's screen turns off, it has entered sleep mode. Briefly press the power button to wake it up. For more information [see **Waking your tablet on page 18**](#).

Sign in to or create a Google account

If you have Internet access, your tablet allows you to synchronize information with a Google account.

During the start-up process, you may create or sign in to an account, which will be used to synchronize your contact list, email, calendar

and other information. If you do not yet have Internet access, or do not want to use this feature, then tap **Skip**.



Important

You must sign in to a Google Account to use Gmail, Hangouts, Google Calendar, and other Google Apps; to download applications from Google Play; to back up your settings to Google servers; and to take advantage of other Google services on your tablet.

If you want to restore existing settings from another device with Android 2.0 (or later) installed, you must sign in to your Google account during setup. If you wait until after setup is complete, your settings will not be restored.

If you have multiple Google accounts, such as separate accounts for personal and business contacts, you can access and synchronize them from the Accounts settings section. [See Multiple Google accounts on page 41](#)

Using the touchscreen

Your tablet uses a touchscreen for selecting items and entering information. Use your finger to tap the screen.

Tap: Touch the screen once to open items and select options.

Drag: Hold your finger on the screen and drag across the screen to select text and images.

Tap and hold: Tap and hold an item to see a list of actions available for that item. On the pop-up menu that appears, tap the action you want to perform.

Scroll: To scroll up or down the screen, simply drag your finger up or down the screen in the direction that you want to scroll.

The Home screen

When you start your tablet, or wake it from power saving, it will display the Home screen. This screen gives you quick access to information and simple controls with widgets or shortcuts to apps. Widgets display information such as the time and weather, or provide additional controls and direct access to applications. Some have been pre-

installed on your tablet, while others may be downloaded from Google Play.

The Home screen already features some useful controls and information.

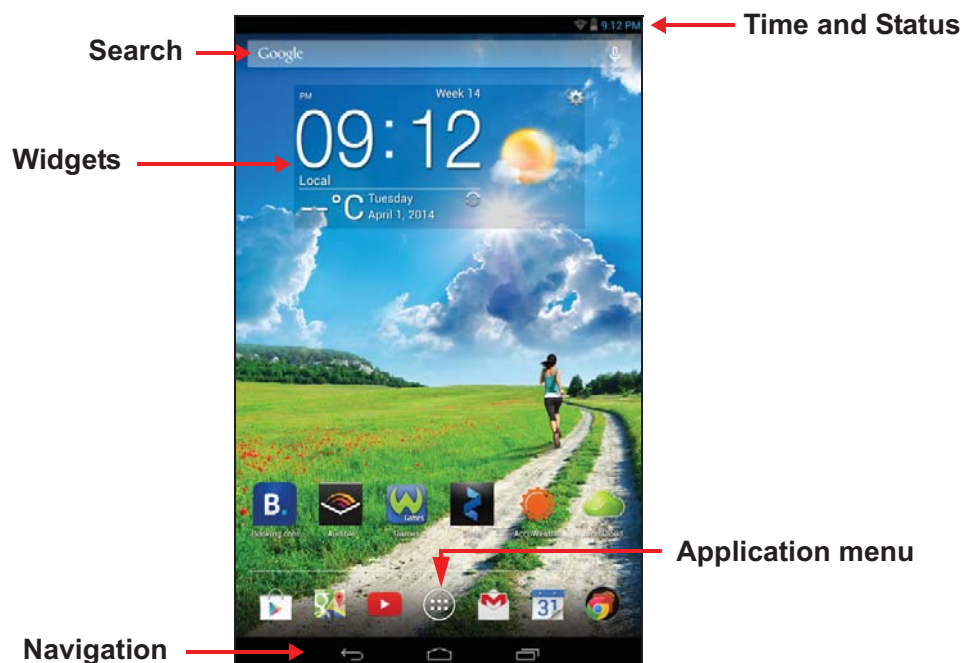

Note

Bundled apps differ depending on region and configuration.

Search

To search for applications, files or for information on the Internet, tap the **Google** icon in the top-left corner.



Simply enter the text you want to find. Tap the arrow or Enter key to search the Internet, or tap one of the suggestions, applications or files shown in the list.

In order to search or browse the Internet, you must be connected to a wireless network. **See Going online on page 22.**

You can also choose what Google Search searches for. Within search, tap the **Back** button to hide the keyboard. Then tap the **Menu** icon > **Settings** > **Tablet search**. Select the applications you want Google Search to search.

Voice search

If voice search is available, tap the microphone and speak your search request. [See Voice Search on page 24.](#)



Navigation

To navigate through menus and options, three (or more) icons are shown at the bottom.

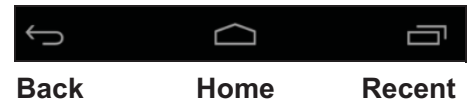

Back

Tap this icon to go to the previous page, or to go up one level in a menu. This icon may be replaced with the *hide* icon in certain cases (such as if the keyboard or list of recent applications is shown).



Home

Tap this icon to go directly to the Home screen.

Recent

Tap this icon to see recently opened applications. Tap an application to open it, or tap anywhere on the screen to return to the Home screen.

The extended Home screen

The Home screen extends to either side of the initial Home screen, giving you more room to add widgets or organize shortcuts. To view the extended Home screen, swipe your finger to the left or right.

A total of five pages are available, two to the left and two to the right. To change or add widgets on any of the screens [see Personalizing the Home screen on page 15.](#)

The application menu

The application menu displays applications and widgets available on your tablet.

Applications are displayed in alphabetical order. Swipe to the left to see more applications. When you are on the last page of applications,

swipe to the left to see widgets available on your tablet. **See Personalizing the Home screen on page 15.**

Adding an application to a Home screen

Tap and hold an icon to add a shortcut to one of your Home screens. When you select an icon, you are taken to the initial Home screen. You can drag the selected icon to any extended home screen.

Status and notification area

Status and notification icons are shown at the top of the screen. The top-right area displays a variety of information, such as time, battery status, and connectivity. The top-left area displays event icons, such as a new message.

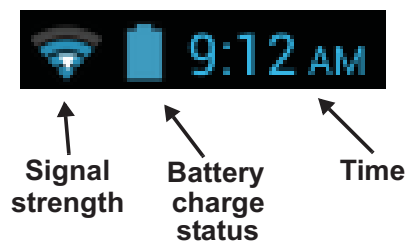

Swipe down from the top-left side to display notification details such as current downloads and media controls such as "play/pause" and "next track" when music is playing. Swipe down from the top-right side to display system controls.

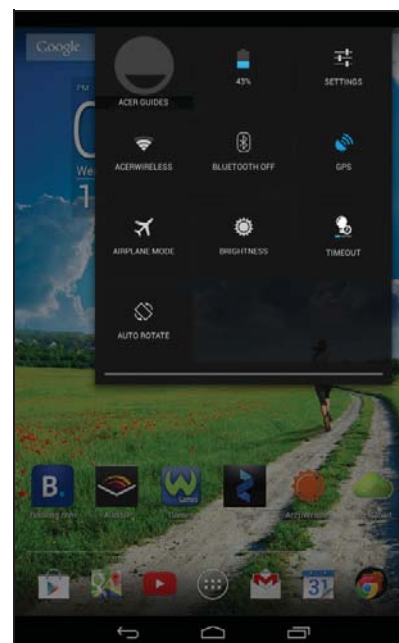
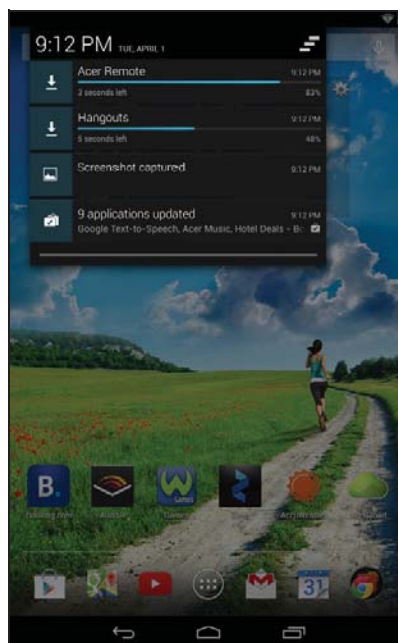





Status and notification icons

Connection icons







Note

The icons displayed on your device vary depending on your connection.

Icon	Description	Icon	Description
	Connected to a wireless network (waves indicate signal strength)		Bluetooth is on
	Airplane mode (wireless connectivity disconnected)		Connected to a Bluetooth device

Battery status icons













Icon	Description	Icon	Description
	Battery is very low		Battery is full
	Battery is low		Battery is charging
	Battery is partially drained		









Note

If your device's battery is getting too hot, you will be notified and advised to turn off the device. If you fail to turn it off, it will shut down automatically.

Notification icons

Icon	Description	Icon	Description
	Alarm is set		Speaker is silenced
	New Gmail message		Tablet microphone is off
	New Hangouts message		GPS is on
	Upcoming event		Receiving location data from GPS
	Song is playing		Syncing data
	SD card or USB storage is full		Sync is on

Icon	Description	Icon	Description
	Tablet is connected to PC via USB		Problem with sign-in or sync
	Application update available		Uploading data
	System update available		Downloading data
	Virtual private network (VPN) status		

Personalizing the Home screen

You may personalize your Home screen by adding or removing application shortcuts or widgets, and by changing the wallpaper.

Adding or removing shortcuts or widgets

To add shortcuts or widgets, tap the **APPS** icon in the bottom-center of the Home screen.

The **APPS** menu contains a list of shortcuts to applications you can drag to a Home screen.

Tap **WIDGETS** to see small applications and links (such as custom shortcuts, contacts or bookmarks) that you can add to a Home screen. Widgets are small applications that display constantly-updated information or quick shortcuts to applications or special functions.

To move an app or widget to the Home screen, tap and hold an item until it is selected. The Home screen will open. Drag the item to any free area on the screen. To view information about the app or widget, drag it to the icon at the top of the screen.

To move the item to a different Home screen, drag it to the side of the screen, the Home screen will switch to the screen in that direction. Release the item when it is positioned correctly.

Resizing a widget

Most widgets can be made larger, so you can give more space to information that is important to you. After placing a widget on the *Home* screen, tap and hold to select it. Four circles will appear, one

on each side; tap and drag a circle to change the size of the widget. Tap **Back** to finish.



Note

Not all widgets can be resized.

Removing an item from the Home screen



To remove an item from the Home screen, tap and hold the item until the **Remove** option appears at the top of the screen. Simply drag the item to the **Remove** option.

Changing the Home screen image

Tap and hold any open space on the Home screen. You can choose from a set of pre-formatted wallpapers, images stored in the Gallery or Photos, selected Wallpapers, or Live wallpapers that feature animated or interactive backgrounds.

The onscreen keyboard

When you tap a text box to enter text, an onscreen keyboard will appear. Simply tap on keys to enter text.

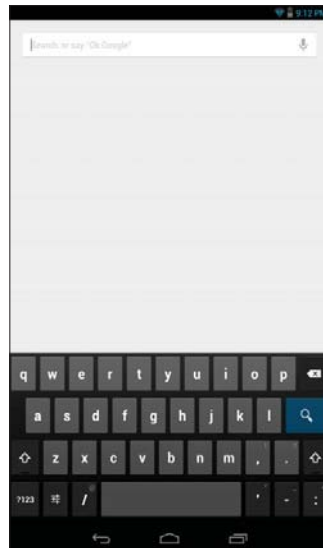

Note

The layout of the keyboard varies slightly, depending on the application and information that is required.

Tap the **?123** button to see numbers and special characters, and then tap the **~\{** key to see more options. Tap and hold a key to select alternative characters (if available for that key), such as letters with accents or related symbols.

Changing Google keyboard settings

To use a different keyboard language or change settings, tap the **Input options** key, then select either **Input languages** or **Google keyboard settings**. These settings include Auto-correction and keyboard sounds. 

Predictive text or auto correction

The Google keyboard can provide predictive text input. As you tap the letters of a word, a selection of words are displayed above the keyboard that continue the sequence of letters tapped, or are a close match allowing for errors. The word list changes after every key press. If the word you need is displayed, you can tap on it to insert it into your text.

To turn predictive text on or off with the Google keyboard, tap the **Input options** key, and then **Google keyboard settings**. Tap **Auto correction** or **Show correction suggestions** and select one of the options.

Editing text

You can select and edit text in certain applications, such as text you have entered in a text field. Selected text can be cut or copied and later pasted within the same application, or to a different application.



Note

Certain applications may not support text selection, or only support it in certain areas. Other applications may offer specialized commands to select text.

Selecting text

To select text that you want to cut, copy, delete or replace:

1. Tap the text you want to select. If you can select this text, a cursor is inserted below the text.
2. Tap and hold the text or word you want to select. The selected text is highlighted, with a tab at each end of the selection.
3. Drag either tab to expand or reduce the amount of selected text, or tap **SELECT ALL**.
4. To cut or copy the text, tap the **CUT** or **COPY** button.

Inserting text

To type new text or add text that you have copied:

1. Tap where you want to insert text. If you can select this text, a cursor is inserted below the text. To replace a word, double tap the word. In both cases, if you previously copied text, a PASTE button displays.
2. If the cursor is not in the desired position, simply drag it to the correct position.



3. Modify the text by typing or deleting text or tapping the PASTE button.

Waking your tablet

If the screen is off and the tablet does not react to any taps on the screen, then it has been locked and is in sleep mode.

To wake your tablet, press the power button. Your tablet will display the Lock screen. To unlock the screen, press the lock button and follow the lock to the right side of the circle.

Security Options

For additional security, you may set a code or number that must be entered to access the tablet, such as an unlock pattern (a set of dots that must be tapped in the correct order). Open the Home screen and tap **APPS > Settings > Security > Screen lock**. If you forget your unlock pattern, please refer to [Unlock pattern on page 44](#).

Shutting down your tablet

If you won't use your tablet for an extended period of time, turn it off to save battery power. To turn off your tablet (even when locked), press and hold the power button for one second. Tap **Power off** and confirm the shut down. To force a shutdown, press and hold the power button for four seconds.

CONNECTING DEVICES TO YOUR TABLET

Connecting to AC power

See [Charging your tablet on page 7](#)

Inserting a microSD card

You may install a microSD card to expand your device's storage space. Ensure that the microSD card is inserted all the way into the card slot.



Note

Your tablet only supports microSD cards that use the FAT or FAT32 file system.

Check card capacity in the **SD CARD** section of **APPS > Settings > Storage**.

Transferring files between your tablet and a PC

Your tablet and any connected storage devices can be accessed from a PC with a USB connection.

Connecting to a PC as a USB storage device

If you wish to transfer information between your device and your computer (either the microSD card in your device or the device's internal memory), you can connect your device to a PC using the supplied USB cable.

1. Plug the USB sync cable into the micro USB connector on your device.

2. Plug the USB client connector into an available USB port on your computer.

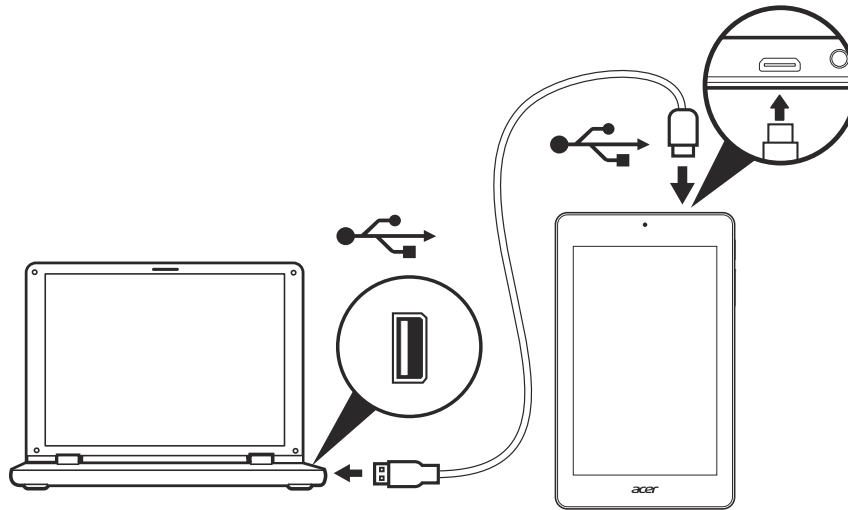

3. Swipe down the top-left notification area and tap **Connected as a media device** to choose whether to connect as a *Media device (MTP)* (the default option) or *Camera (PTP)*.

Your device will now be available as a drive in your computer's file explorer.

Connecting a Bluetooth device

Only A2DP stereo headsets (playback only, no microphone) are supported. Please check for updates to the tablet's software which may add support for additional Bluetooth devices.

For Bluetooth settings, tap **APPS > Settings**, then under **WIRELESS & NETWORKS** tap Bluetooth.

Turn Bluetooth on and tap **Search for devices** to scan for nearby devices.

Accessories

For a complete list of accessories, visit store.acer.com.

GOING ONLINE

Managing Wi-Fi connections

If you did not connect to a Wi-Fi network when you first started your tablet, or want to connect to a new network, tap **APPS** > **Settings** > **Wi-Fi** to manage your connection settings. Alternatively, swipe down from the top-right of the screen and tap the Wi-Fi button to toggle on and off the Wi-Fi connection.

If Wi-Fi is not on, tap the Wi-Fi **ON** switch and wait for your tablet to detect nearby networks. Tap the name of your network and enter a security password, if needed.

Browsing the Internet

In order to browse the Internet with your tablet, you must be connected to a network with a connection to the Internet.

Using the browser

To start browsing, tap the **Chrome** icon on the Home screen, or open the application menu and select **Chrome**. To enter a website address, tap the address box at the top of the page. Enter the address using the keyboard and tap **Go**.



To navigate forward and backward in your browser's history, view your bookmarks, adjust browser settings, and perform other tasks, tap the **Menu** icon.



Chrome enables you to open multiple tabs. When a page is open, tap the small **New tab** button. Simply tap one of the open tabs across the top of the screen to switch pages.



Pinch to zoom in or out of pages. Tap and hold an item on a page to open a contextual menu.

Setting up the Email application

The Email application enables you to access email from most popular email providers. Most accounts can be set up in two steps. Open the application menu and then tap **Email** to start setting up your email access.

Enter your email address and password tap **Manual setup** to enter the parameters manually or simply tap **Next** to finish the setup process.

The combined inbox feature of your tablet allows you to view emails from multiple accounts in a single inbox.

Google services



Note

Applications may not be available in all countries and regions.

You must activate a Google account before using Google services. The first time you access Google services, you must read and accept the Terms of Service.

The contents and design of Google Play varies by region. For example, in some regions, you can also browse for and purchase movies, books, magazines, or music. Updates may add new categories or change how to navigate Google Play at any time.

Setting up your Google email

1. Make sure your tablet is connected to the Internet.
2. From the application menu tap **Gmail**.

If you did not enter a Gmail account address and password when you first started your tablet, follow the instructions.

Composing an email

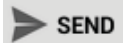
1. Make sure your tablet is connected to the Internet.
2. Open the application menu and tap **Gmail**.
3. Tap .
4. Enter the recipient's email address, the subject and message.
5. When you are finished composing your message, tap .

When you are finished composing your message, tap **Send**.

Voice Search



Note

Voice Search is available only in selected regions.

With voice actions, you can send emails, find directions to locations, search the Internet and even send a note to yourself using your voice. In Chrome, tap the microphone icon in the address bar for voice searches. When the **Speak now** prompt displays, state your

command or query then press the red microphone button. Your command displays in the search box. Tap **Go** on the keyboard to complete the command or query.

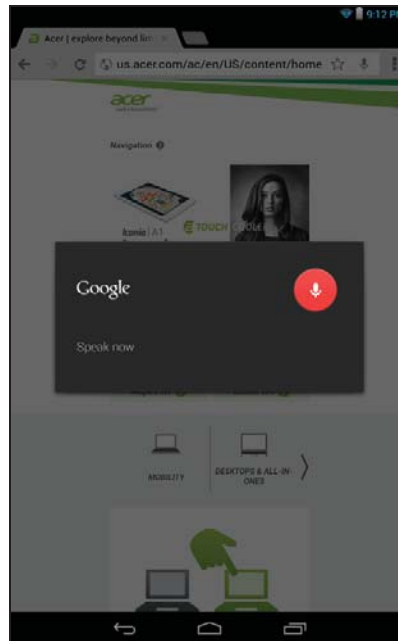

Play Store

Tap **Play Store** from the home screen or application menu to open *Google Play*. Here you can obtain a variety of add-on programs and applications to enhance the functionality of your tablet.

You can browse Google Play by category or tap the search icon to search for a specific application.

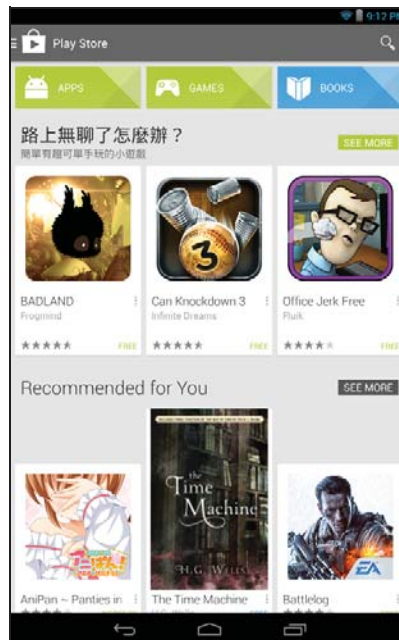

For the best user experience, you are advised to not download apps that use 3D graphics.

Once you have selected an application, tap the **Install** button to download and install the application. You will be told which services (contact information, wireless access, GPS, etc.) the application requires access in order to function correctly. If none of these services seem unusual, tap **Accept & download** to proceed with the installation.

You may keep track of the download progress from both the app's page and the tablet's notification area.

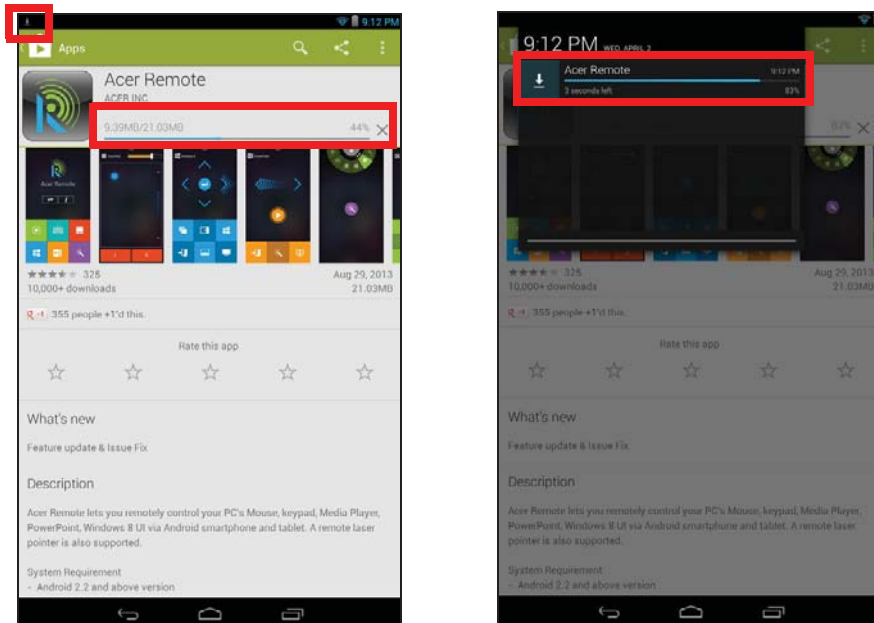

Important

Some applications may require payment before you can download them. You will need to have a Google Wallet account in order to pay for these applications.

Using downloaded applications

Once you've downloaded and installed an application, you may find it in the **APPS** or **WIDGETS** sections of the application menu.

Certain applications provide both an app and widget, or only provide a widget (with no application icon). See [Personalizing the Home screen on page 15](#).

Uninstalling downloaded applications

Once you've downloaded and installed an application, you may uninstall the application from **APPS** > **Settings** > **Apps**, then select the the app you wish to uninstall and tap **Uninstall**. Deleting an app icon from the Home screen only deletes the shortcut.

Google Hangouts

Tap **Hangouts** from the application menu to open Google Hangouts. Here you can see a list of your contacts connected to Google

Hangouts services. Tap on a contact to open a chat session. After you have connected, you can open a video chat session.

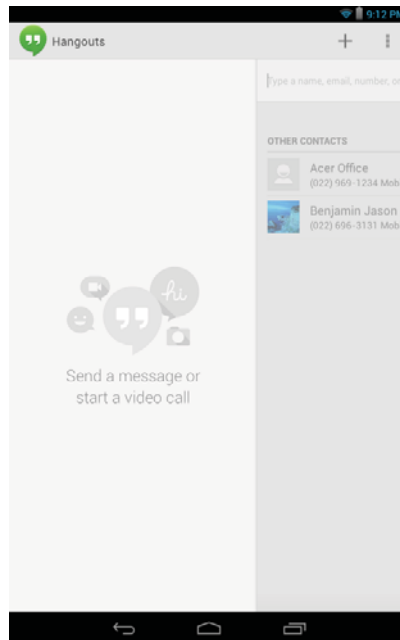

PLAYING MUSIC

Multimedia playback

Your tablet comes supplied with a variety of programs that you can use to enjoy multimedia content.



Note

The available option of Google Play Music varies by region. For example, in some regions, Google Play Music can serve as cloud storage for your personal music collection and make it available on all your devices. Updates may change how to navigate these media apps at any time.

Play Music

Use **Play Music** to listen to music and other audio files that you download or copy from your computer, USB drive, mass storage device, etc.



Tap **APPS > Play Music** to open the application.



Swipe in from the left side (or tap the headphones icon in the top-left corner of the screen) to display a menu. The menu contains a list of views, such as Listen Now, My Library, and Playlists and also Settings, Help, and Send feedback. You can return to the Home page while playing music. The current track along with basic music control functions appear in the notification area. **See Status and notification area on page 13.**

MANAGING PEOPLE AND CONTACTS

Your tablet features an address book that allows you to save contacts to the internal memory or your Google account.

Tap **People** from the application menu to view your contacts.

If you don't have any contacts stored on your tablet, you can sync with your Google account contacts, import contacts from a contact data file (vCard or csv) or add a new contact.

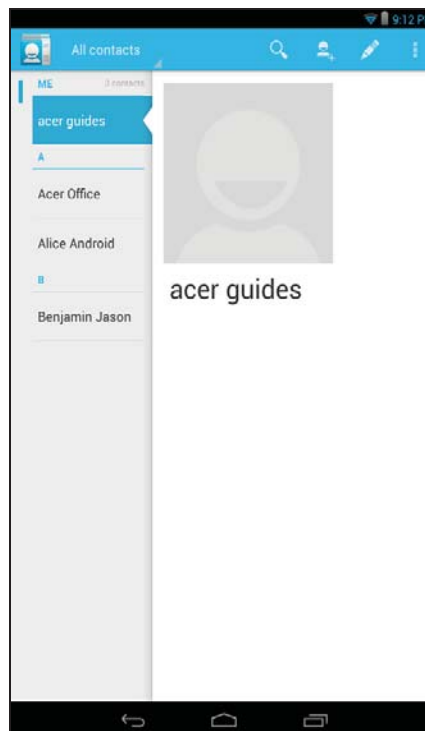

If you have activated a Google account that includes contacts, your contacts will be synchronized automatically. [See Synchronization on page 40.](#)

Importing contacts

Tap the **Menu** button and select **Import/export** > **Import from storage**. Your contacts will download to your tablet.



Adding a new contact

Tap  to add a new contact. If you have multiple accounts, you will be asked which account you want to use to store the contact. The contact will be synchronized with that account.

You may now edit the new contact entry.

Editing a contact

If you have opened a new contact, you can enter information about the contact. To modify an existing contact, from the main screen select the contact in the list on the left. Then tap . Now simply tap on a box and type the appropriate information.

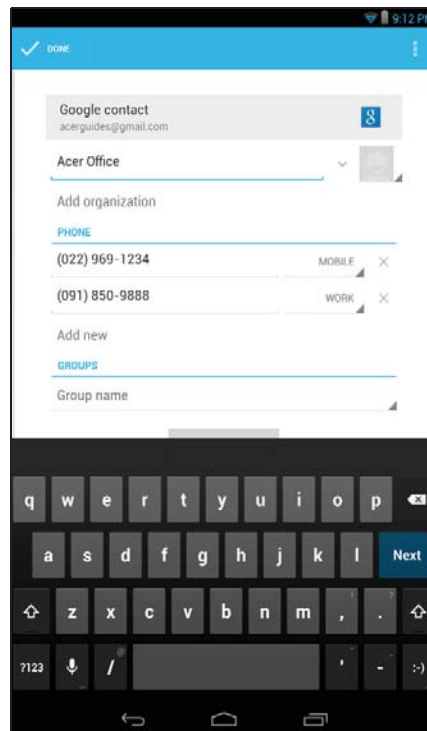

Click on the arrow next to the name entry to see options, such as adding a name prefix or phonetic name.

To enter multiple entries, such as separate entries for mobile and home phone numbers, tap the **Add new** to create a second entry. Tap the **X** to remove an entry.

Tap **Add another field** for more categories.

To assign an image to your contact, tap the silhouette and either select an image from your tablet's picture gallery (select **Choose photo from Gallery**). You may also take and crop a new photo.

Tap **Done** (top-left corner) to finish and save the contact.



Note

Set each phone number to match the type of network as this can determine some functions, i.e. certain applications only recognize 'Mobile' numbers as they require a function only available on a mobile network.

Opening a contact

To see the information stored for a contact, tap on the contact's name in the list on the left.

Tap on an entry (such as an email address) to open the application linked to that type of entry. For example, tap an email address to open the **Email** application.

Starred contacts

You may quickly access your favorite contacts by adding a *star*. First open the contact, then tap the star next to the contact's name. Tap **All contacts** and select **Favorites** to see only your favorite contacts.

Editing a contact on your computer

If you have synchronized your Google account and contacts, you can use your computer to access and edit your contact list. Open the internet browser on your computer and go to **contacts.google.com**. Sign in to your account then select and edit contacts from the list; the next time your tablet synchronizes with your computer, these changes will also be made to your tablet's contact list.



Important

Back up your contacts before making any changes. Tap the *Menu* button and select Import/Export. You may then Export your contact list to your tablet's internal memory, or other options depending on installed applications.



USING THE CAMERA AND CAMCORDER

Your tablet features a front- and rear-facing digital camera. This section will take you through all the steps in taking photos and videos with your tablet.



Note

It is recommended that you insert a microSD card into the microSD slot before using the camera.

You can only save photos and videos to internal memory or a microSD card, not an external USB storage device.

To activate the camera or camcorder, open the application menu and tap **Camera**.

Camera/camcorder icons and indicators

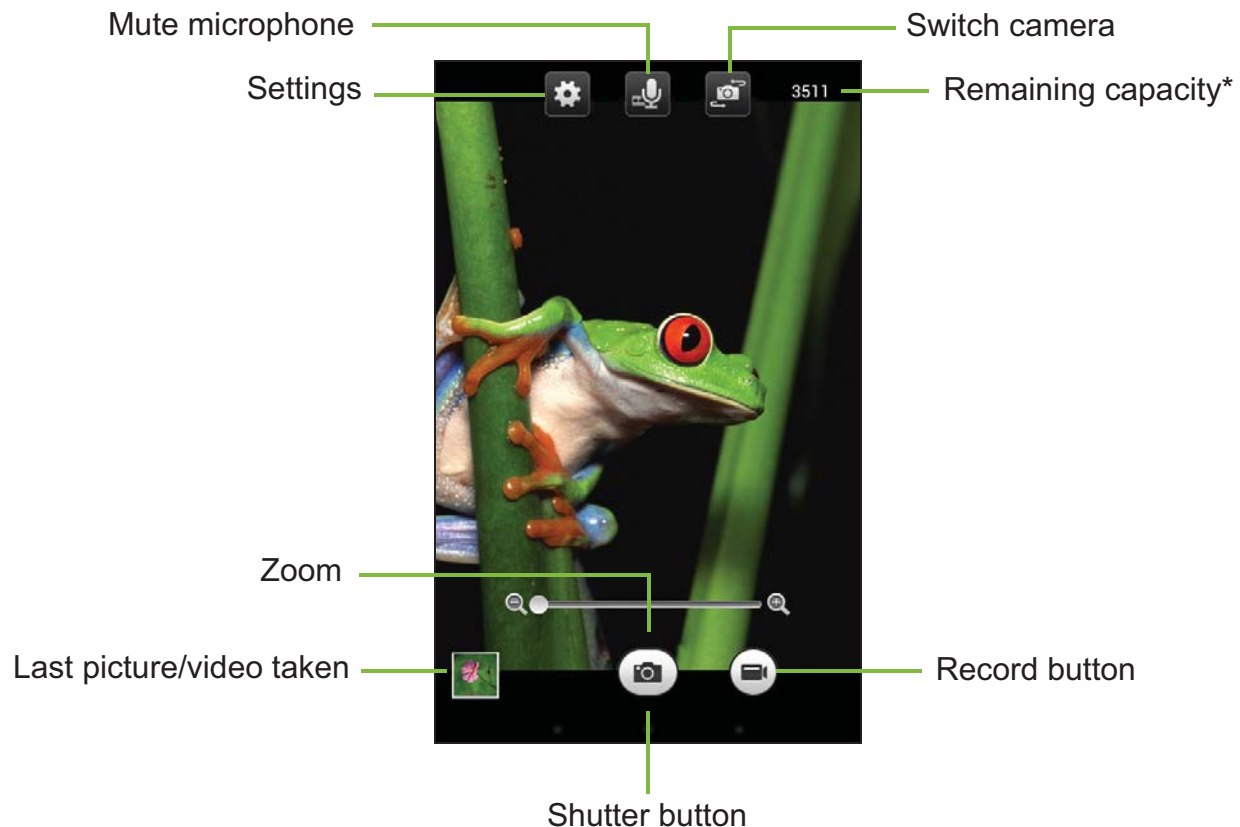



* The listed capacity is the approximate number of images that can be taken at the current resolution.

In the camera window, the controls at the top of the screen allow you to change settings. The controls at the bottom allow you to take a picture, select camera or camcorder, zoom in or out, and view the last picture/video taken.

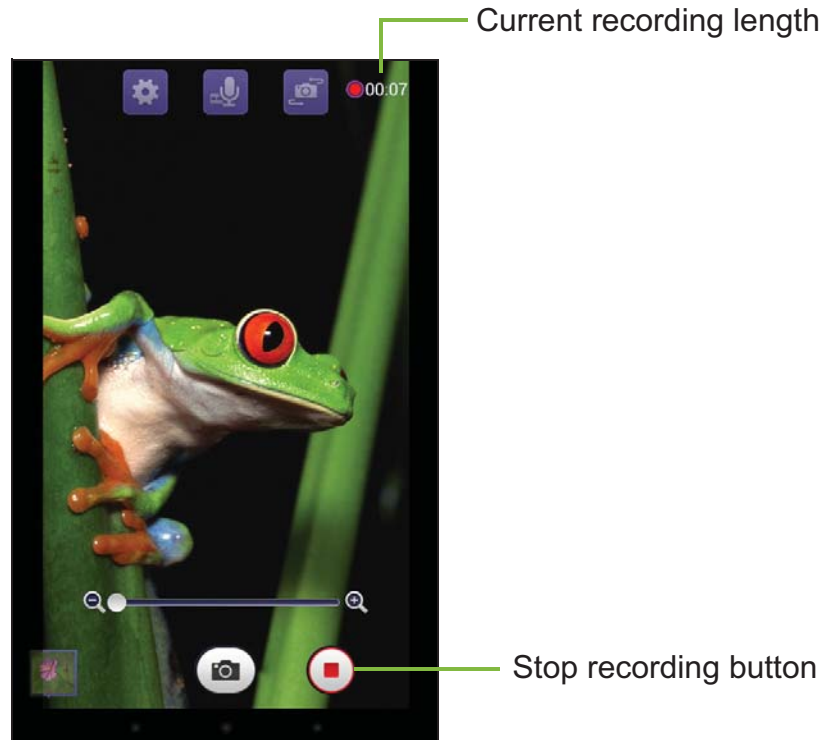
Tap the **Record** button and the camcorder immediately begins filming. While filming, you are unable to access camera/camcorder settings; however, you can still take pictures. Tap the red **Stop recording** button to stop filming.



Settings

Icon	Description
Settings 	<p>Camera settings</p> <ul style="list-style-type: none"> • Exposure: Increase or decrease image exposure: -1, 0, +1. • White balance: Change the color balance to match the lighting: Auto, Daylight, Cloudy, Fluorescent lamp, or Incandescent. • Timer: Set the automatic timer for 2, 5, or 10 seconds. • Grid: Toggle 9x9 grid squares on or off. <p>Camcorder settings</p> <ul style="list-style-type: none"> • Time lapse interval: Set the time lapse interval from 1, 2, 5, or 10 seconds. <p>General settings</p> <ul style="list-style-type: none"> • Location: Set if the location (from GPS) is stored in the image information. A satellite icon appears on the screen when active. • Reset to default: Return camera settings to the original conditions.
Mute microphone 	Before recording a video, tap the icon to turn the microphone on or off (the icon is disabled while recording.)
Switch camera 	Toggle between front and rear cameras.

Taking a photo

1. Ensure the options described above are set to your preferences.
2. Frame your subject and steady your tablet.
3. Zoom in or out as needed using the zoom slider.



Note

When using zoom, the image on the screen does not represent the quality of the final image.

4. Tap the shutter button to take the photo.



Shooting a video

1. Ensure the options described above are set to your preferences.
2. Frame your subject and steady your tablet and zoom in or out as needed.
3. Tap the record icon to begin recording.
4. Tap the record icon again to stop recording.

Supported formats

Type	Formats
Image	JPEG
Video	H.264 BP, MPEG-4 SP, H.263
Audio	AAC-LC, AMR-WB, AMR-NB

Viewing photos and videos

1. After you have taken your photo or video, it is automatically saved; normally to internal memory. You can view it by tapping the thumbnail in the corner of the screen. Alternatively, open the application menu and tap **Gallery**, then **Camera**. Select the photo or video you want to view (videos are marked with a small play symbol). From the Gallery you can share the file using various services and edit the image using various options. Tap  to see which sharing options are available for the file or tap  to display image editing options.

ADVANCED SETTINGS

Access Settings from the application menu. Tap **APPS**, then **Settings**.



Wireless & Networks

Activating or deactivating connections

Tap **APPS > Settings**, then under **WIRELESS & NETWORKS** each connection has an ON/OFF switch that controls the connection. Tap an entry to manage your connection settings.

Alternatively, swipe down from the top-right side of the screen to manage connection settings.

Adjusting Bluetooth settings

You can use Bluetooth to exchange information between your tablet and other mobile devices.

Bluetooth connections

For all Bluetooth settings, tap **APPS > Settings**, then under **WIRELESS & NETWORKS** tap **Bluetooth**. Here you can switch

Bluetooth on or off, set the tablet name and discoverability. Tap **SEARCH FOR DEVICES** to scan for nearby devices.

To connect to a device, tap the device in the list of available devices. You may be asked to enter a PIN on both devices to establish the connection.



Note

Only A2DP stereo headsets (playback only, no microphone) are supported. Please check for updates to the tablet's software which may add support for additional Bluetooth devices.

Data Usage

The *Data Usage* section shows how much data has been transmitted to your tablet, either in total or for each app. This information is useful if you are using a metered service.

Putting your tablet in Airplane mode

You can enter Airplane mode (also known as flight mode) to turn off network and Bluetooth functions and use your tablet during a flight. Check with your airline to make sure this is permitted onboard.

Switch your tablet off during takeoff and landing as it may interfere with aircraft electronic systems.



Note

When Airplane mode is active, the ✈ icon is displayed in the status area.

To turn Airplane mode on or off, tap **Settings**, then under **WIRELESS & NETWORKS** tap **More... > Airplane mode**.

Alternatively, swipe down from the top-right side of the screen to toggle airplane mode on or off.

Virtual Private Network (VPN)

This option enables you to connect to a private network, such as a secure work or office environment.

Add a VPN by tapping **Settings**, then under **WIRELESS & NETWORKS** tap **More... > VPN > Add VPN network**.

Device

Sound

Adjust the volume of your tablet using the volume buttons on the side of the tablet. Alternatively, you can adjust your tablet sound settings by tapping **APPS > Settings > Sound**.

Item	Description
Volumes	Sets volume for Media, Alarm, and Notifications.
Default notification sound	Sets a ringtone for Notifications.
Touch sounds	Plays a sound whenever a screen selection is made.
Screen lock sound	Plays a sound when locking and unlocking the screen.

Display

You can adjust your tablet screen settings by tapping **APPS > Settings > Display**.

Item	Description
Brightness	Adjusts screen brightness.
Wallpaper	Set the Home screen background image.
Sleep	Sets a delay before the screen will be turned off.
Daydream	Controls what happens when the tablet is docked and/or sleeping.
Font size	Sets the font size so either more text is visible or the text is easier to read.



Note

You can enable or disable the screen rotation function by swiping down from the top-right side of the screen and tapping the **AUTO ROTATE** button.

Apps

Closing an application

To close an active application, go to **Settings > Apps**. Swipe over to the **RUNNING** tab, then tap the program you wish to close. Select **Stop** to close the program.

Uninstalling an application

You can remove programs installed on your tablet to free up extra storage memory. Tap and hold a program icon from the application menu and drag it into the **Uninstall** area in the top-left corner.



Note

You cannot uninstall applications that were pre-loaded on your tablet.

Alternatively, you can go to **APPS > Settings** and select **Apps**. Tap the application you wish to uninstall, tap **Uninstall** and confirm the uninstall.



Important

You should only remove programs if you are familiar with the Android operating system.

Personal

Synchronization

You can configure synchronization options for many applications on your tablet. You can also configure what types of data you synchronize for each account.

Some applications, such as People, Gmail, and Calendar, can sync data from multiple accounts. Others sync data only from the first Google Account you sign in to on your tablet, or from an account associated specifically with that application.

For some applications, such as People or Calendar, all changes that you make on your tablet are made to the synchronised copy on the Internet. Other applications only copy information from account on the

Internet; the information on your tablet cannot be changed directly, you must change the information stored in the Internet account.

Tap **APPS > Settings > [Account]** to manage the synchronization of individual accounts.

Some applications, such as Gmail and Calendar, have additional synchronization settings. Open the application and tap the *Menu* button (three dots) and then tap **Settings**.



Multiple Google accounts

If you have multiple Google accounts, such as separate accounts for personal and business contacts, you can access and synchronize them from the Accounts settings section. Tap **APPS > Settings > Add account**.

Changing language and text options

Set your location and language input preferences by tapping **APPS > Settings > Language & input**.

System

Setting the date and time

To set the date and time, tap **APPS > Settings > Date & time**.



Note

*If you travel frequently or live in an area that uses daylight saving time, and have mobile network access, activate **Automatic date & time** from this menu. Your tablet will set the date and time based on information it receives from the network.*

Setting alarms

There are two predefined alarms on your tablet by default. To add or edit alarm settings, tap **Clock** in the application menu and tap . Tap the ON/OFF switch next to a preset alarm to turn it on or off or tap the **+** button to create a new alarm.

Tap a preset alarm to edit it. You can:

- Set the alarm time.
- Give it a label (i.e., a name).
- Set which days to repeat the alarm.
- Set a ringtone.

Updating your tablet's operating system

Your tablet can download and install system updates, adding support for new devices or expanding software options.

To check for updates, tap **APPS > Settings > About tablet > System updates > Check now**.



Note

Downloading new firmware can take up to 40 minutes, depending on your network speed. Do not press the power or reset button or access your tablet in any way during a system upgrade to prevent firmware installation failure.

Resetting your tablet

A clean boot restores your tablet to the factory settings.



Important

This will erase all your personal information, any contacts stored on your tablet and any programs you installed.

To perform a clean boot, open **Settings** from the application menu, then tap **Backup & reset > Factory data reset**; tap **Reset tablet** and then **Erase everything** to format your tablet.

FAQ AND TROUBLESHOOTING

This section lists frequently asked questions that may arise during the use of your tablet, and gives easy answers and solutions to these questions.

Aspect	Question	Answer
Audio	Why is there no sound coming from the device?	If the headset is plugged into the device, the speaker is automatically shut off. Disconnect the headset. Check that the device volume setting is not muted. Check that the volume control is not at its lowest setting.
Memory	Why do I have less storage than the specifications say?	A small amount of memory is reserved for system security.
Multimedia files	Why can't I view my picture files?	You may be trying to view an image that is not supported. See Supported formats on page 36 for more information.
	Why can't I view my video files?	You may be trying to view a video that is not supported. See Multimedia on page 46 for more information.
	Why can't I play my music files?	You may be trying to play a file that is not supported. See Multimedia on page 46 for more information.

Aspect	Question	Answer
System information and performance	How do I check the OS version of my device?	Tap APPS > Settings > About tablet to check the OS version (Kernel/build number) and other hardware and software information.
	Where can I find my serial number ID?	Tap APPS > Settings > About tablet > Device Information .
Power	I couldn't turn on the device.	The battery power may be depleted. Recharge the device. See Charging your tablet on page 7 for more information.
Storage	How do I check memory status?	To check storage status, go to Settings > Storage .
	What do I do when my device's internal storage is full or almost full?	You may need to delete installed apps or move media files to the microSD card.
Unlock pattern	I forgot my unlock pattern.	After five wrong entries, you can reset your unlock pattern. Tap Forgotten pattern? and enter your Google account username and password. <i>You must have an active Google account on the tablet and an Internet connection.</i> If this option is not available, please contact your local Acer service center.

Aspect	Question	Answer
Heat	The tablet heats up when charging or operating for a long period.	<p>It is normal for the device to heat up when charging. When charging is complete, it will return to its normal temperature.</p> <p><i>It is also normal for the tablet to heat up during long periods of use, such as watching a video or playing a game.</i></p> <p><i>All Acer tablets are factory-tested before release.</i></p>

Other sources of help

For information on:	Refer to:
Up-to-date information regarding your tablet	www.acer.com
Service enquiries	support.acer.com

SPECIFICATIONS

Performance

- Intel® Atom™ processor 1.6 GHz processor
 - System memory:
 - 1 GB of RAM
 - 8 or 16 GB of flash memory
- Google Android™ operating system

Display

- 7" TFT-LCD capacitive multi-touch screen
- 1280 x 800 resolution (for B1-730HD models)
- 1024 x 600 (for B1-730 models)

Multimedia

- Dual speakers
- Built-in microphone

Formats supported:

Type	Formats
Audio recording	AAC-LC, AMR-WB
Audio playback	AAC-LC, AAC, AAC+ (not raw AAC), AMR-NB, AMR-WB, MP3, OGG Vorbis, WAV
Video recording	H.264 BP, MPEG-4 SP, H.263 BP
Video playback	H.264 BP, H.264 MP, H.264 HP, MPEG-4 SP, H.263 BP

USB connector

- Micro USB port

Power

- DC power-in (5.35 V, 2 A)

Connectivity

- Bluetooth 3.0
- Wi-Fi IEEE 802.11b/g/n
- GPS

Camera

- Front camera
 - 0.3-megapixel
 - Fixed focus
- Rear camera
 - 2-megapixel
 - 720p HD audio/video recording

Expansion

- microSD card slot (up to 32 GB)

Battery

- 14 Wh 3680 mAh 3.8 V 1-cell Li-polymer battery pack
Battery life: Up to 7.0 hours (based on video playback test results)



Note

Length of battery operation will depend on power consumption which is based on system resource use. For example, constantly using the backlight or using power-demanding applications will shorten battery life between charges.

Dimensions

Height	197.5 mm
Width	120 mm
Thickness	9.10 mm (for B1-730 models) 8.95 mm (for B1-730HD models)
Weight	320 g

Environment

Temperature

Operating: 0° C to 35° C

Non-operating: -20° C to 60° C

Humidity (non-condensing)

Operating: 20% to 80%

Non-operating: 20% to 80%

END USER LICENSE AGREEMENT

IMPORTANT - READ CAREFULLY: THIS END USER LICENSE AGREEMENT ("AGREEMENT") IS A LEGAL AGREEMENT BETWEEN YOU (EITHER AN INDIVIDUAL OR A SINGLE ENTITY), AND ACER INC. INCLUDING ITS SUBSIDIARIES ("ACER") FOR THE SOFTWARE (WHETHER PROVIDED BY ACER OR BY ACER'S LICENSORS OR SUPPLIERS) THAT ACCOMPANIES THIS AGREEMENT, INCLUDING ANY ASSOCIATED MEDIA, PRINTED MATERIALS AND RELATED USER ELECTRONIC DOCUMENTATION WHICH MAY BE BRANDED "ACER", "GATEWAY", "PACKARD BELL", OR "EMACHINES" ("SOFTWARE"). AGREEMENTS RELATING TO ANY OTHER PRODUCT OR TOPIC ARE NEITHER INTENDED NOR SHOULD THEY BE IMPLIED. BY INSTALLING THE ACCOMPANYING SOFTWARE OR ANY PORTION THEREOF, YOU AGREE TO BE

BOUND BY THE TERMS AND CONDITIONS OF THIS AGREEMENT. IF YOU DO NOT AGREE TO ALL OF THE TERMS AND CONDITIONS OF THIS AGREEMENT, DO NOT CONTINUE THE INSTALLATION PROCESS AND IMMEDIATELY DELETE ALL INSTALLED FILES, IF ANY, OF THE ACCOMPANYING SOFTWARE FROM YOUR DEVICE.

IF YOU DO NOT HAVE A VALIDLY-LICENSED COPY OF THE APPLICABLE SOFTWARE, YOU ARE NOT AUTHORIZED TO INSTALL, COPY OR OTHERWISE USE THE SOFTWARE, AND HAVE NO RIGHTS UNDER THIS AGREEMENT.

The Software is protected by U.S. and international copyright laws and conventions as well as other intellectual property laws and treaties. The Software is licensed, not sold.

GRANT OF LICENSE

Acer grants to you the following non-exclusive and non-transferable rights with respect to the Software. Under this Agreement, you may:

1. Install and use the Software only on a single designated device. A separate license is required for each device on which the Software will be used;

2. Make one copy of the Software solely for backup or archival purposes;
3. Make one hard copy of any electronic documents included in the Software, provided that you receive the documents electronically.

RESTRICTIONS

You may NOT:

1. Use or copy the Software except as provided in this Agreement;
2. Rent or lease the Software to any third party;
3. Modify, adapt, or translate the Software in whole or in part;
4. Reverse engineer, decompile, or disassemble the Software or create derivative works based upon the Software;
5. Merge the Software with any other program or modify the Software, except for your personal use; and

6. Sublicense or otherwise make the Software available to third parties, except that you may, after prior written notification to Acer, transfer the Software as a whole to a third party so long as you do not retain any copies of the Software and such third party accepts the terms of this Agreement.
7. Transfer your rights under this Agreement to any third parties.
8. Export the Software in contravention of applicable export laws and regulations, or (i) sell, export, re-export, transfer, divert, disclose technical data, or dispose of, any Software to any prohibited person, entity, or destination including, without limitation,

Cuba, Iran, North Korea, Sudan and Syria;
or (ii) use any Software for any use

prohibited by the laws or regulations of the
United States.

SUPPORT SERVICES

Acer is not obligated to provide technical or
other support for the Software.

ACER LIVE UPDATE

Certain software contains elements that
enable the use of the Acer Live Update
service, which allows for updates for such
software to be automatically downloaded and
installed on your device. By installing the
software, you hereby agree and consent that

Acer (or its licensors) may automatically check
the version of such software that you are using
on your device and may provide upgrades to
such software that may be automatically
downloaded on to your device.

OWNERSHIP AND COPYRIGHT

Title, ownership rights and intellectual property
rights in and to the Software and all copies
thereof shall remain with Acer or Acer's
licensors or suppliers (as applicable). You do
not have or shall not gain any proprietary
interest in the Software (including any
modifications or copies made by or for you) or
any related intellectual property rights. Title
and related rights in the content accessed
through the Software is the property of the
applicable content owner and may be

protected by applicable law. This license gives
you no rights to such contents. You hereby
agree:

1. Not to remove any copyright or other
proprietary notices from the Software;
2. To reproduce all such notices on any
authorized copies you make; and
3. To use best efforts to prevent any
unauthorized copying of the Software.

TRADEMARKS

This Agreement does not grant to you any
rights in connection with any trademarks or
service marks of Acer or of Acer's licensors or
suppliers.

DISCLAIMER OF WARRANTIES

TO THE MAXIMUM EXTENT PERMITTED BY
APPLICABLE LAW, ACER, ITS SUPPLIERS,
AND ITS LICENSORS, PROVIDE THE
SOFTWARE "AS IS" AND WITH ALL FAULTS,
AND HEREBY DISCLAIM ALL OTHER
WARRANTIES AND CONDITIONS, EITHER
EXPRESS, IMPLIED OR STATUTORY,
INCLUDING, BUT NOT LIMITED TO, ANY
IMPLIED WARRANTIES, DUTIES OR
CONDITIONS OF MERCHANTABILITY, OF
FITNESS FOR A PARTICULAR PURPOSE,
OF ACCURACY OR COMPLETENESS OF
RESPONSES, OF RESULTS, OF
WORKMANLIKE EFFORT, OF LACK OF
VIRUSES, AND OF LACK OF NEGLIGENCE,
ALL WITH REGARD TO THE SOFTWARE
AND THE PROVISION OF OR FAILURE TO
PROVIDE SUPPORT SERVICES. ALSO,

THERE IS NO WARRANTY OR CONDITION
OF TITLE, QUIET ENJOYMENT, QUIET
POSSESSION, CORRESPONDENCE TO
DESCRIPTION OR NON-INFRINGEMENT
WITH REGARD TO THE SOFTWARE.

EXCLUSION OF INCIDENTAL,
CONSEQUENTIAL AND CERTAIN OTHER
DAMAGES

TO THE MAXIMUM EXTENT PERMITTED BY
APPLICABLE LAW, IN NO EVENT SHALL
ACER, ACER'S SUPPLIERS, OR ACER'S
LICENSORS, BE LIABLE FOR ANY
SPECIAL, INCIDENTAL, INDIRECT,
PUNITIVE, OR CONSEQUENTIAL
DAMAGES WHATSOEVER (INCLUDING,
BUT NOT LIMITED TO, DAMAGES FOR
LOSS OF PROFITS OR CONFIDENTIAL OR
OTHER INFORMATION, FOR BUSINESS

INTERRUPTION, FOR PERSONAL INJURY, FOR LOSS OF PRIVACY, FOR FAILURE TO MEET ANY DUTY INCLUDING OF GOOD FAITH OR OF REASONABLE CARE, FOR NEGLIGENCE, AND FOR ANY OTHER PECUNIARY OR OTHER LOSS WHATSOEVER) ARISING OUT OF OR IN ANY WAY RELATED TO THE USE OF OR INABILITY TO USE THE SOFTWARE, THE PROVISION OF OR FAILURE TO PROVIDE SUPPORT SERVICES, OR OTHERWISE UNDER OR IN CONNECTION WITH ANY PROVISION OF THIS AGREEMENT, EVEN IN THE EVENT OF THE FAULT, TORT (INCLUDING NEGLIGENCE), STRICT LIABILITY, BREACH OF CONTRACT OR BREACH OF WARRANTY OF ACER OR ITS SUPPLIERS OR LICENSORS, AND EVEN IF ACER AND ITS SUPPLIERS AND LICENSORS HAVE BEEN ADVISED OF THE POSSIBILITY OF SUCH DAMAGES.

LIMITATION OF LIABILITY AND REMEDIES NOTWITHSTANDING ANY DAMAGES THAT YOU MIGHT INCUR FOR ANY REASON WHATSOEVER (INCLUDING, WITHOUT

LIMITATION, ALL DAMAGES REFERENCED ABOVE AND ALL DIRECT OR GENERAL DAMAGES), THE ENTIRE LIABILITY OF ACER, ITS SUPPLIERS, AND ITS LICENSORS, UNDER ANY PROVISION OF THIS AGREEMENT, AND YOUR EXCLUSIVE REMEDY FOR ALL OF THE FOREGOING, SHALL BE LIMITED TO THE AGGREGATE AMOUNT PAID BY YOU FOR THE SOFTWARE. THE FOREGOING LIMITATIONS, EXCLUSIONS AND DISCLAIMERS (INCLUDING DISCLAIMER OF WARRANTIES AND EXCLUSION OF INCIDENTAL, CONSEQUENTIAL AND CERTAIN OTHER DAMAGES ABOVE) SHALL APPLY TO THE MAXIMUM EXTENT PERMITTED BY APPLICABLE LAW, EVEN IF ANY REMEDY FAILS ITS ESSENTIAL PURPOSE; PROVIDED, HOWEVER, THAT BECAUSE SOME JURISDICTIONS DO NOT ALLOW THE EXCLUSION OR LIMITATION OR LIABILITY FOR CONSEQUENTIAL OR INCIDENTAL DAMAGES, THE ABOVE LIMITATION MAY NOT APPLY TO YOU.

TERMINATION

Without prejudice to any other rights, Acer may immediately terminate this Agreement without notice if you fail to comply with any terms and conditions of this Agreement.

In such event, you must:

1. Cease all use of the Software;

2. Destroy or return to Acer the original and all copies of the Software; and
3. Delete the Software from all devices on which it was resident.

All disclaimers of warranties and limitation of liability set forth in this Agreement shall survive termination of this Agreement.

GENERAL

This Agreement represents the complete agreement between you and Acer relating to this license for the Software and supersedes all prior agreements, communications, proposals and representations between the parties and prevails over any conflicting or additional terms of any quote, order, acknowledgement or similar communication.

This Agreement may only be modified by a written document signed by both parties. If any provision of this Agreement is held by a court of competent jurisdiction to be contrary to law that provision will be enforced to the maximum extent permissible and the remaining provisions of this Agreement will remain in full force and effect.

ADDITIONAL PROVISIONS APPLICABLE TO THIRD PARTY SOFTWARE AND SERVICES

Software provided hereunder by Acer's licensors or suppliers ("Third Party Software") is made available to you for your personal, non-commercial use only. You may not use the Third Party Software in any manner that could damage, disable, overburden, or impair

the services provided by Acer's licensors or suppliers hereunder ("Third Party Services"). Furthermore, you may not use the Third Party Software in any manner that could interfere with any other party's use and enjoyment of the Third Party Services, or the services and

products of Acer's licensors' or suppliers' third party licensors. Your use of the Third Party Software and Third Party Services is also

subject to additional terms and conditions and policies which can be accessed through our global website.

Privacy policy

During registration you will be asked to submit some information to Acer. Please refer to Acer's privacy policy at www.acer.com/worldwide/support/swa.htm or your local Acer website.