

# Contents

CONTENTS .....	1
THE ANDROID ADVANTAGE .....	3
READ ME FIRST .....	3
DISCLAIMER .....	3
GETTING STARTED.....	5
UNDERSTAND YOUR PHONE .....	5
SIM CARD INSERTION .....	5
MEMORY CARD INSERTION .....	7
HANDSET KEYS .....	8
CHARGING THE BATTERY .....	9
BASIC PHONE FEATURES .....	10
GOOGLE™ ACCOUNT.....	10
HOME SCREEN .....	11
APPLICATION LAUNCHER .....	11
NOTIFICATIONS.....	12
GRAVITY SENSOR .....	13
PHONE LOCKING TECHNIQUES.....	14
USE GOOGLE™ SEARCH.....	17
USING THE TOUCH SCREEN .....	18
TAP AND HOLD .....	18
DRAG AN ITEM.....	18
SCROLL .....	18
SWIPE.....	19
USING THE PINCH ZOOM.....	19
DOUBLE-TAP.....	19
GESTURES .....	<b>ERROR! BOOKMARK NOT DEFINED.</b>
USING THE ONSCREEN KEYBOARD.....	20

RECENT APPLICATIONS .....	21
CALLING AND MESSAGING .....	22
MAKE A CALL.....	22
CONTACTS .....	22
AIRPLANE MODE .....	23
SEND MESSAGE.....	24
MULTIMEDIA .....	25
CAMERA .....	25
GALLERY .....	25
MUSIC PLAYER.....	26
FM RADIO .....	27
VIDEO PLAYER.....	27
.....	28
SETTINGS, NETWORKS, AND APPLICATIONS.....	29
CONNECT TO THE INTERNET .....	29
TETHERING & PORTABILITY .....	30
PAIR WITH BT DEVICES.....	31
CONFIGURING E-MAIL.....	32
GOOGLE™ MAPS.....	33
MANAGE APPLICATIONS .....	34
SAFETY PRECAUTIONS .....	34
TAKING CARE OF YOUR DEVICE.....	36
BATTERY RECOMMENDATIONS .....	37
RECYCLE YOUR PHONE.....	37
COPYRIGHT.....	38

# The Android Advantage

Micromax A290 comes with KitKat 4.4.2 that is capable of performing various functions just like your personal computer and can be personalized according to your own needs. For example, you can add and remove applications or upgrade existing applications to improve the functions. At the Android market, an ever growing range of applications, games, movies, and books are available for you to download.

## Read Me First

- Please read all safety precautions and this manual carefully before using your device to ensure safe and proper use.
- The descriptions in this manual are based on the default settings of your device.
- Available features and additional services may vary by device, software, or service provider.
- Applications and their functions may vary based on the country, region, software or hardware specifications. Micromax is not liable for performance issues caused by third-party applications.

## Disclaimer

- The colors, specifications, functions and graphics shown/mentioned in the user manual may differ from the actual product. In such a case, the latter shall govern. Images shown are for representation purpose only. Specifications are subject to change without prior

notice. Micromax keeps the right to modify the content in this user guide without prior notice.

- Upon first use of your device, your device will send information related to your mobile, IMEI numbers, location details and other software details through SMS\* automatically. This information may be used as further specified in Micromax privacy policy\*\*.
- Talk and standby times are affected by network preferences, type of SIM cards, connected accessories and individual usage patterns. Services and some features may be dependent on the network, service/content providers, SIM cards, compatibility of the devices used and the content formats supported.
- Other product logos and company names mentioned herein may be trademarks or trade names of their respective owners.

\*Operator tariff shall be applicable for SMS.

\*\*Micromax privacy policy is available at [www.micromaxinfo.com](http://www.micromaxinfo.com).

# Getting Started

## Understand Your Phone

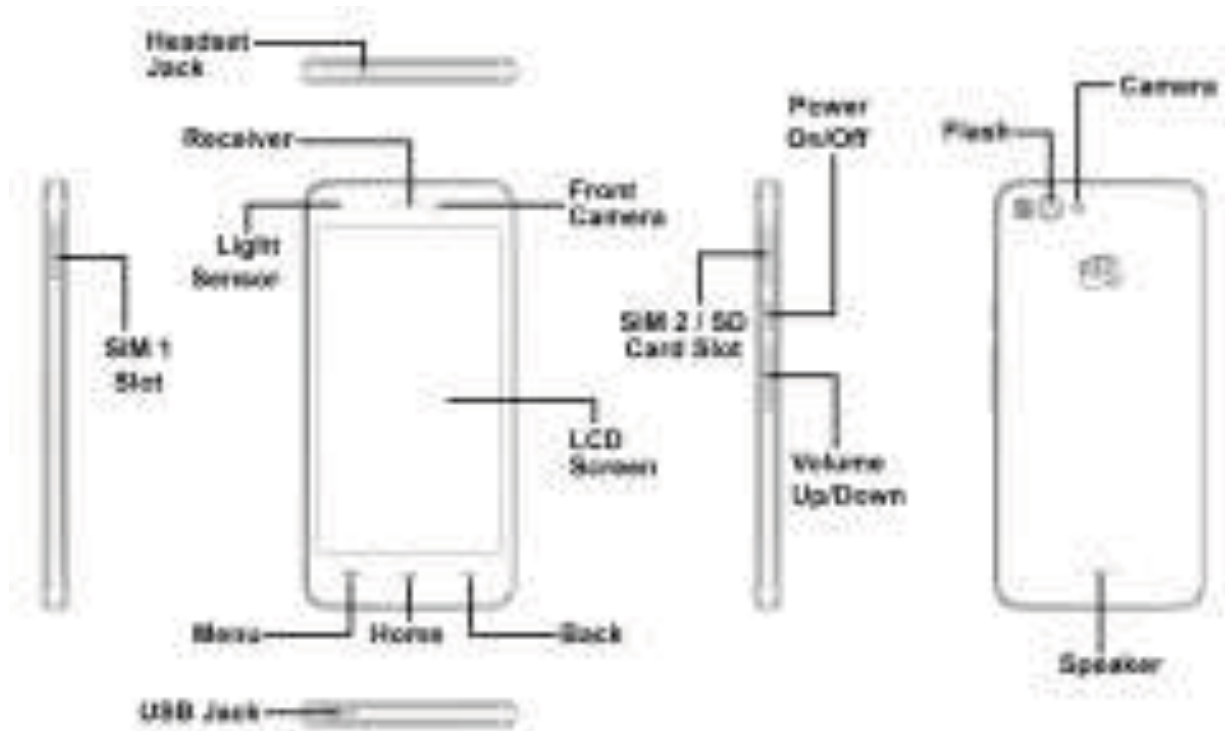

## SIM Card Insertion

Your A290 is a dual-SIM phone that supports micro SIM and nano SIM. Switch off your phone before SIM insertion/removal and insert the SIM card in the SIM slots as shown in the following images:

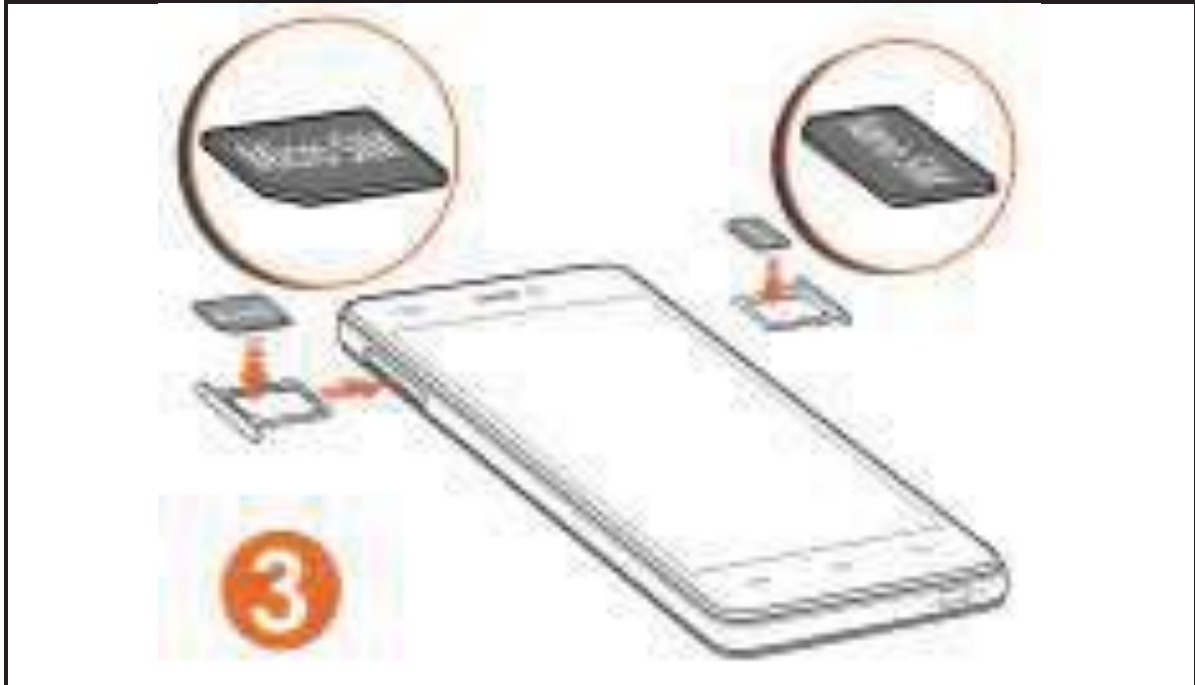

ⓘ	Please keep the SIM card out of the reach of children.
ⓘ	The card and the contacts are vulnerable to damage due to scratching or bending. Therefore, be careful when using, inserting or removing the cards.

## Memory Card Insertion

To store additional multimedia files, you must insert a memory card. Insert the memory card as shown in the following image:



**Note:** The slot for nano-SIM card and memory card is the same in this device. You can insert either the SIM card or the memory card at one time.



Use only compatible memory cards approved by Micromax with this device. Incompatible memory cards may damage the card or the device and

---



---

corrupt the data stored in the card.

---

## Handset Keys

---

Keys	Functions
	<ul style="list-style-type: none"><li>• Long press to switch on or switch off the phone.</li><li>• Press once to turn off the screen or to wake up the screen.</li><li>• Press for 2 seconds to view quick options to turn off the phone, reboot the device, switch to airplane mode, or adjust the sound profiles.</li></ul>
	<ul style="list-style-type: none"><li>• Adjust the phone volume from the volume keys available on the right side of the device.</li></ul>
	<ul style="list-style-type: none"><li>• Opens a menu with items that affect the current screen or application.</li><li>• If tapped when on the home screen, opens options to personalize the home screen.</li><li>• On long tap, opens the most</li></ul>

---



---

recently used applications.

---



- Opens the Home screen.
  - On long tap, opens Google™ Now.
- 



- Opens the previous screen you were working on.
  - If the onscreen keyboard is open, closes the keyboard.
- 

## Charging the Battery

Before using the device for the first time, you must charge the battery. You can charge the device with a travel adapter or connecting the device to a PC with a USB cable.

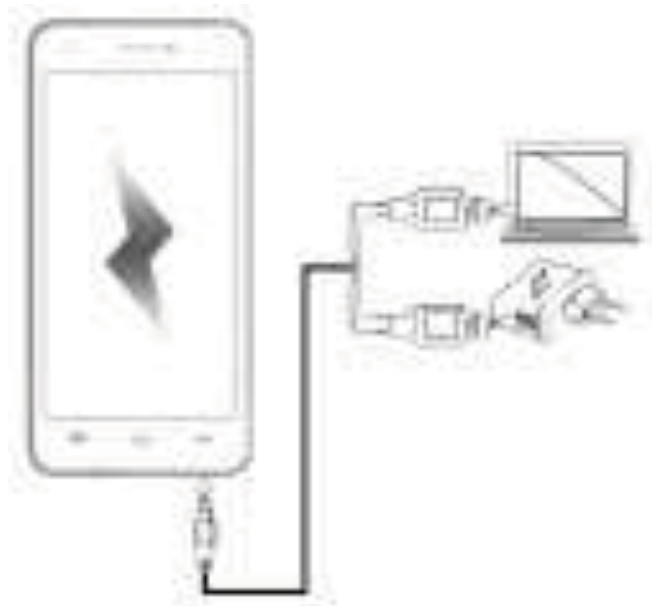

You can also use a compatible USB charger to charge your battery.

---



Use only Micromax approved chargers and cables. Unapproved chargers or cables can cause battery to

---

---

explode or damage your device.

---



We suggest you charge the battery for 4 hours continuously for the first time.

---



## Basic Phone Features

### Google™ Account



Your Google™ Account lets you take full advantage of applications and services offered by Google™ Android market. Configure your Google™ account on this handset to get access to your Google™ mails, Google™ Play Store, Google™ Maps, and much more.

Google™ account setup will be prompted when you turn on your handset for the first time.



Network connection will be required for the Google™ account setup step to appear.

---

However, you may configure your Google™ account at any later stage from  →  → **Add account** → **Google**. Follow the registration steps to successfully configure your mail account on the device.



If you do not have an existing Google™ account, you may create one from the account configuring step.

---



You may add various other accounts, depending on your applications.

---

## Home Screen

You can personalize your home screen with shortcuts, widgets, wallpapers and other items. To view quick options to change wallpaper, add widgets, or open settings section, tap the  key. You can add extensions to the home screen by placing widgets or application shortcuts on the extended home screen. Your A290 will show only those extended home screens which have some shortcut/widget placed on them. Swipe left or right on the home screen to view the next extended home screen.

In the bottom pane, there will be five launcher icons for you to open different sections in the phone. Except the application launcher in the middle of the pane, you can rearrange and manage the other four icons. Tap and hold to select a launcher icon and then you can rearrange, change, or remove them with ease.

### **Know More About Widgets...**

Widgets allow placing application shortcuts on your home screen. You can place analog clock, your recent call logs, and other such sections of your phone on the home page and access them directly! View all available widgets by tapping the  key and then tapping **Widgets**.

## Application Launcher

Application launcher or Application menu is available right in the middle of the home screen bottom pane.



Tap  to view all inbuilt and installed applications. In the application menu, tap and hold any application to take it to the home screen; release the hold to place at any desired location on the home screen.

## Notifications

Notification icons inform you of new messages and events as and when it appears in the device.

### Open Notification Panel



**Open the Toolkit**

### Close Notification Panel



**Clear all Notifications**



|

When you receive a notification, its icon appears in the status bar, along with a brief summary. You may clear each notification separately by swiping it towards left or right.

Toolkit provides you shortcuts to manage basic phone features, such as Airplane Mode, Wi-Fi, Display Brightness, and many more.

## Gravity Sensor

Your phone has gravity sensor to detect gravity and display correct orientation based on the motion.

You can enable/disable the auto-rotate feature by dragging down the notification panel, tapping , and then select **AUTO ROTATION**.

Or

You can enable/disable the auto-rotate feature from  →  → **Display** → **Auto-rotate screen**.

## Phone Locking Techniques

You may need to provide PIN, password, draw a pattern, take your face in front of the phone screen, speak something for voice recognition, or simply slide to unlock your phone.

Slide unlock will be the default unlocking method in the phone.  
To unlock the screen:

1. Press the power key to wake up the phone.
2. Hold and drag the lock icon upwards.

---

### Face Recognition



Allows you to keep your face as screen unlocking password. You just need to look at your phone to unlock it.

Look at your phone to unlock it!

---

### Voice Recognition



Allows you to provide your voice as the screen unlocking password. You need to speak something for the phone to recognize your voice and unlock the screen.

Speak your password to unlock!

---

### PIN

You may enter a PIN

---



and set it as your screen unlocking password.

Enter your PIN to unlock your phone!

---

### **Pattern**

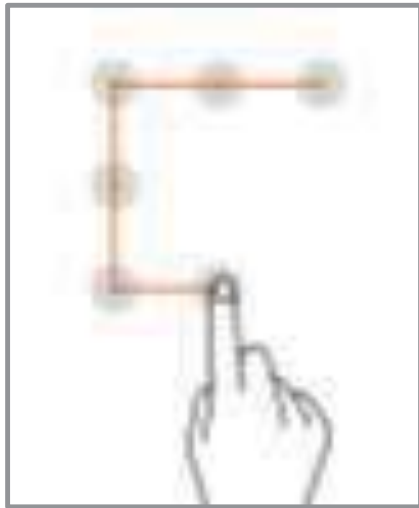

You can set your own pattern by connecting the dots to prevent your phone from unauthorized access.

Set and draw your desired pattern!

---

### **Password**

You may enter any desired password and set it as your screen unlocking password.

---



Enter your password to unlock!

---

### Slide

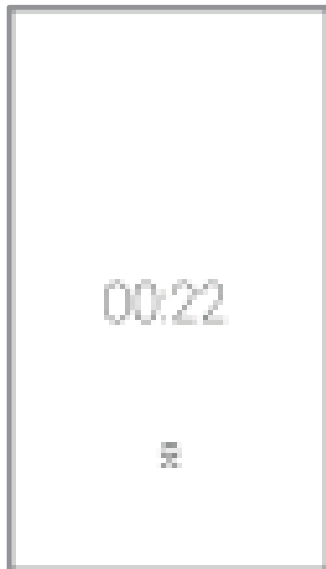

Just wake up the screen and slide the icon upwards to unlock your phone.

Slide the lock icon upwards!



You may set any desired locking technique from 

→  → **Security** → **Screen lock.**



It is important to remember your screen lock password/pattern/PIN.

---

You can disable all unlocking methods from your handset by selecting the **None** option.



## Use Google™ Search

Search anything in your phone or in the outside world from Google™ Search. You can type your search keywords or can even speak it up as your search supports voice recognition also. Use voice commands to access various useful sections on your handset.

Google™ Search is available on the home screen and in the application menu too.

# Using the Touch Screen

## Tap and Hold

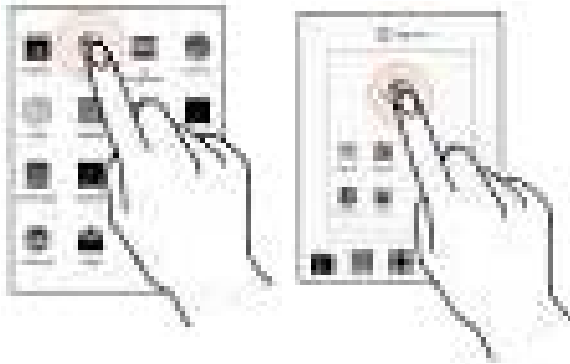

Tap and hold an item to view the list of actions based on the selected item and condition. Also, you can move an item from the Apps screen to the home screen using this method.

## Drag an Item

Tap and hold an item and move your finger on the screen until you reach the target position. The item follows your finger.

You can generally drag items from one location to another on the home screen. Also, you can delete items from the home screen by holding the item and dragging it to the **Remove** label that becomes available only when you hold the item on the Home screen.

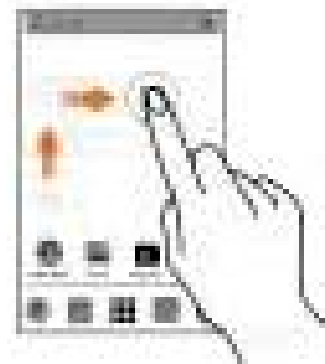

## Scroll

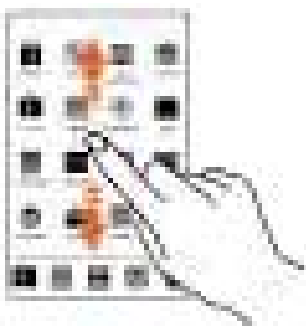

To scroll a list, slide your finger across the surface of the screen upwards or downwards (without dragging an item).

## Swipe

Place a finger on the screen and steadily slide your finger in the desired direction.

For example, when you are viewing a picture, to view the next picture, swipe left.

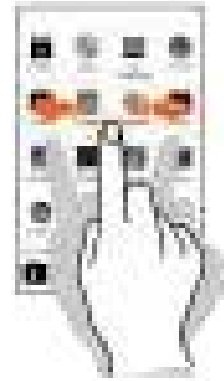

## Using the Pinch Zoom

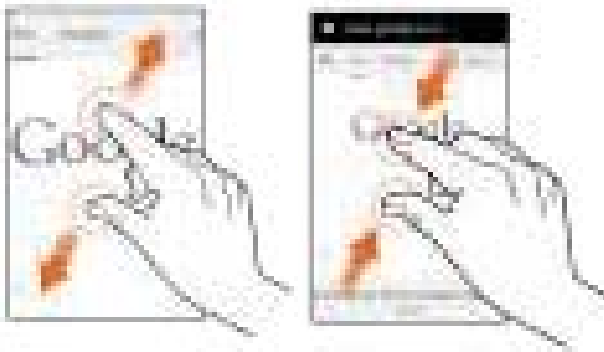

You can open any image or web page and then use your thumb and index finger to zoom the display through the pinch gesture.

## Double-tap

Tap quickly twice on a webpage, map, or other screen to zoom. For example, double-tap a section of a webpage in the browser to zoom that section.

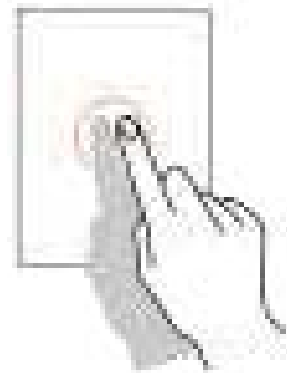

## Using the Onscreen Keyboard

Some applications display the keyboard by default. In others, you will be required to tap a text field, where you want to enter text, to open the keyboard.

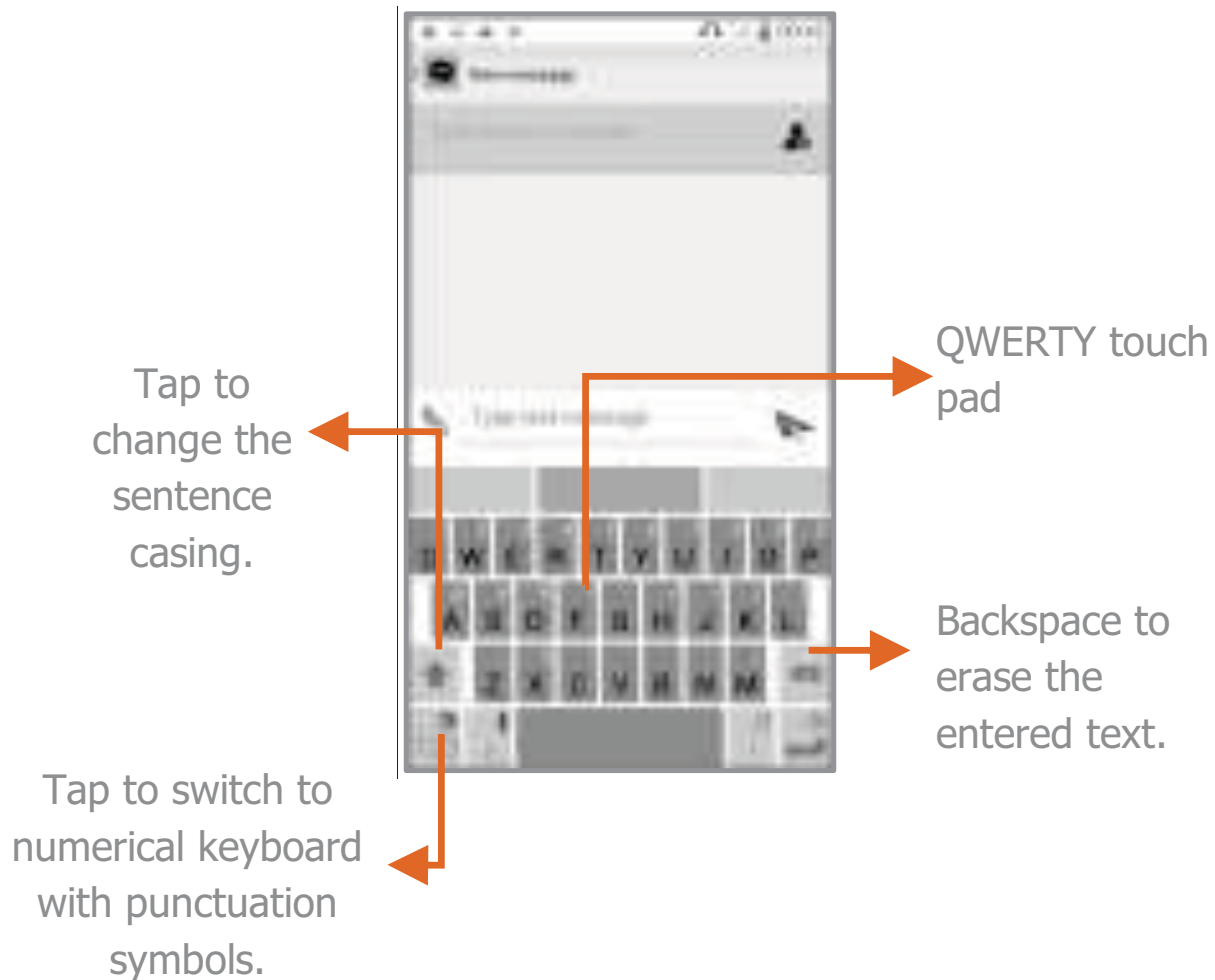

After typing, tap  key to close the keyboard.



Tap and hold the text field to open a menu and to cut/copy/paste text.

---

# Recent Applications

Tap and hold the  key on the home screen to view the list of recent applications. You can easily remove items from the list to free some memory and make your phone work faster.

There are two ways to remove items from the list.

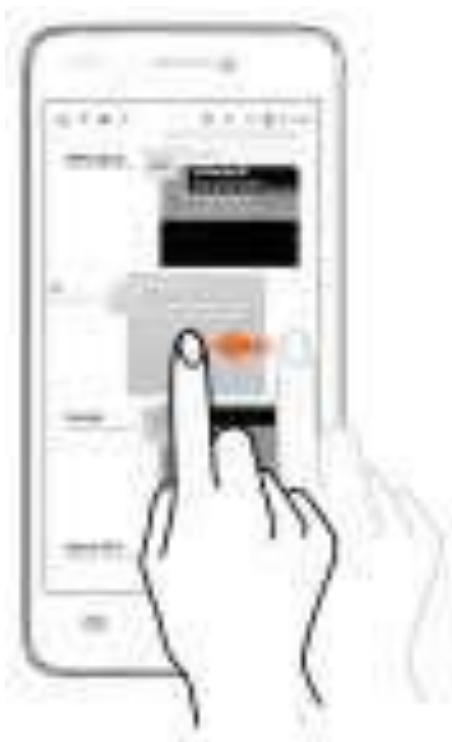

Drag an item towards left or right.

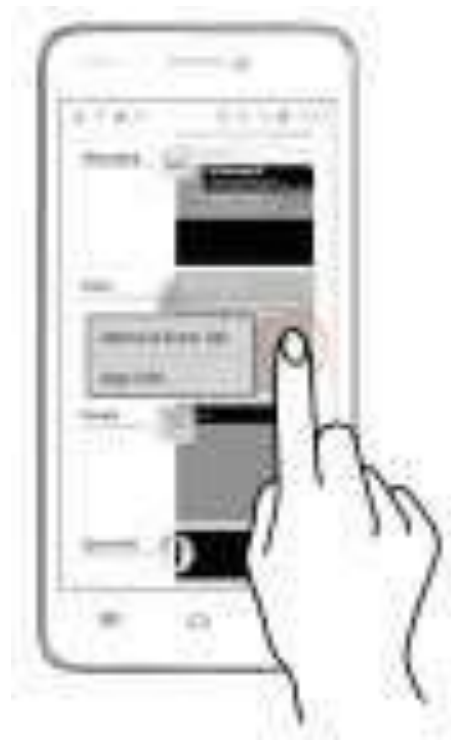

Tap and hold an item and then select "Remove from list".



# Calling and Messaging

## Make a Call

To make a call:

Tap  on the menu screen or the home screen to open the dial pad for making calls.

By default, the dialer will display a list of contacts on which calls have been made very often and the contacts which have been marked as favorites.

You can show the dialer by tapping  or view the call history by tapping .

## Contacts

Go to  → 

Store, use, and synchronize contact details in your contact list. You can now create contact groups or mark contacts as favorites in your phonebook. Use tabs or swipe through to view the list of contact groups, contacts, and favorite contacts list.

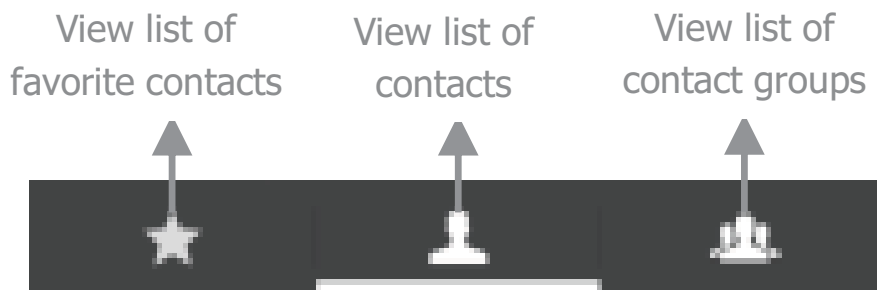

Search for your desired contacts under any of the three tabs by tapping  icon.

---



Add a new contact in the contacts list by tapping .

---

You can synchronize your contacts list with any of your accounts configured on this device.

To synchronize your contacts list:

1. Tap the  key from the contacts screen and then tap **Accounts**.
2. Select the account(s) with which contacts list is to be synchronized. You can auto-sync contacts by selecting the **Auto-sync app data** option.

Your contacts synchronization will be complete in a few seconds.



To synchronize contacts, you need to have Internet connectivity via your SIM or Wi-Fi. If your sync does not proceed as expected, check whether data option is set to ON.

---

## Airplane Mode

Some locations may require you to disable all the wireless features of your mobile. The Airplane Mode enables you to disable all incoming and outgoing calls, Wi-Fi, and BT connections.

To activate the airplane mode:

1. Press and hold the Power button and then select **Airplane mode**.





Or

Drag notification panel down, tap , and then select

## AIRPLANE MODE.

### Send Message

To send a message:

1. Tap  on the menu screen or the home screen to go to the messaging section and then tap  to compose a message.
2. Tap the  icon to view the types of files that can be attached and select the desired type of multimedia file.
3. Tap to select the composition text box and enter your message body in it.
4. Enter the contact name (if it exists) or enter the phone number. You can also tap the  icon to view and select contact(s) from the contact list.
5. Tap  to send the multimedia message.



# Multimedia

## Camera

Go to  → 

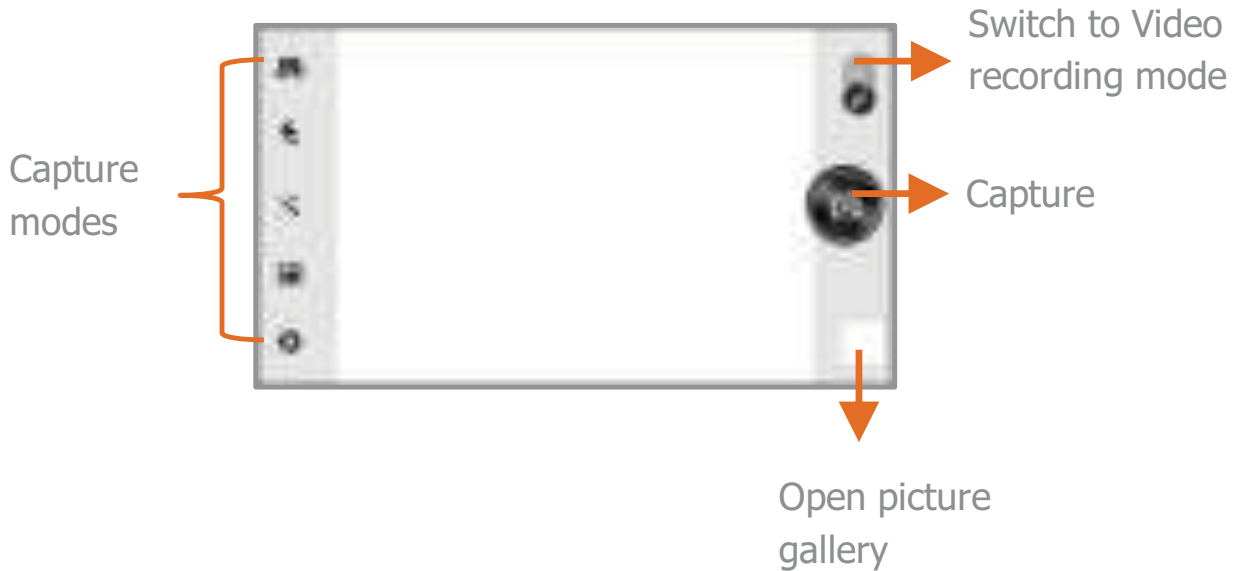

Your device has the following additional camera features on the home screen:

**Photo:** Capture photos from the camera.

**Video:** Shoot videos using your phone.

**Selfie:** Capture selfie photos using the front camera.

**Frontback:** Capture a photo with the front camera and another photo with the back camera and share them as a single image.

**Stable:** Use this feature to stabilize your shots.

## Gallery

Go to  → 

You can use the Gallery to view pictures and play videos and share files. Tap an album to open and view its contents.

## Music Player

Go to  → 

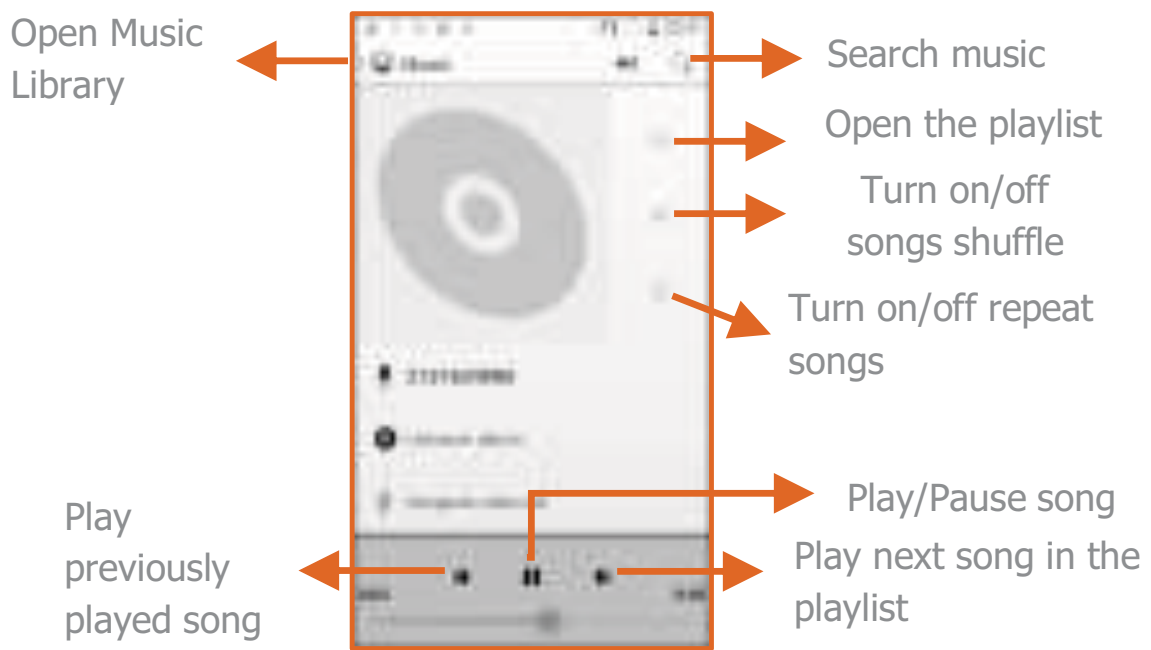

Press the phone's volume up/down keys on the right side of the mobile phone to adjust the volume.



You can use an SD card to enhance the storage capacity for your multimedia files such as music, photos, emails, and so on.

## FM Radio

Go to  → 

You can listen to your favorite FM channels using the inbuilt FM receiver of your phone. Before starting the FM, you need to plug-in the headset as it works as antenna for the FM radio. Use the intuitive buttons and icons on the phone in the radio interface to enjoy the features of your inbuilt FM radio.



Press the phone's volume up/down keys on the right side of the mobile phone to adjust the volume.

---

## Video Player

Go to  → 







# Settings, Networks, and Applications

Your phone can connect to a variety of networks and devices, including Internet, Wi-Fi, GPRS, BT, devices, such as headsets. You can also transfer files to/from your PC through the data cable.

## Connect to the Internet

To configure Internet:

1. Go to  →  → **More** → **Mobile networks** → **Access Point Names** and select the SIM for which access point name is to be configured. Select the access point name if required.
2. Go to  →  → **Dual SIM Setting** → **Data connection** and select the SIM on which data connection is to be enabled.
3. Enable data connection.



By default, your network provider sends the access point name settings via SMS, or it comes with your SIM card. You may need to install these settings. After this, you can choose from the listed access point names. If the access point names are not listed by default, please contact your network provider for the same.

---

On the home screen of your device, there is a Quick Look application, where you can choose your topics of interest from

the available list and this application will show you the latest developments/ updates in your chosen topics of interest:



Swipe your finger to the right to open the list of topics.

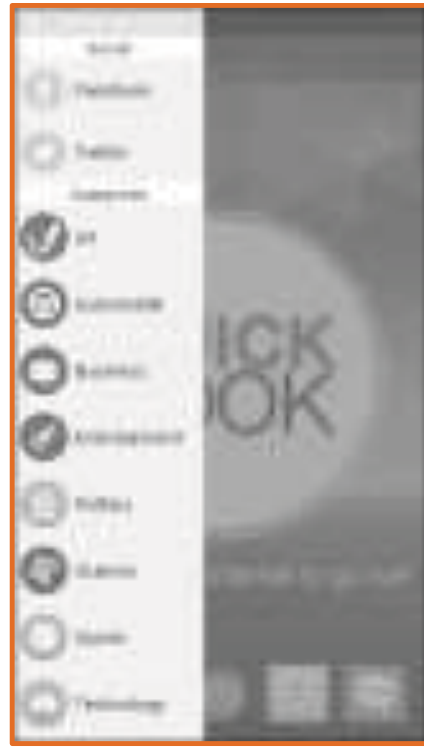

Select your topics of interest to receive regular updates.

**Note:** You must be connected to the Internet to receive the updates.

## Tethering & Portability

You can use your A290 as a modem and connect your PC or laptop to the Internet, when required. Start using your SIM data pack on your PC or Laptop now!

Go to  →  → **More** → **Tethering & portable hotspot.**

## USB Tethering

1. Connect your phone with your PC/Laptop via USB cable.
2. Select the **USB tethering** option.
3. Select your phone network as the network connection in your PC/laptop and get access to the Internet.

## BT Tethering

1. Pair your phone with the BT enabled PC/laptop via BT pairing option.
2. Select the **BT tethering** option in your phone.
3. On the paired PC/laptop, select the BT device (your phone) and choose to connect to the Internet.

## Wi-Fi hotspot

1. Turn on the **Wi-Fi hotspot** option in your phone.
2. On the other Wi-Fi enabled PC/laptop/handset, choose your phone as a Wi-Fi network to connect with it.
3. View and configure Wi-Fi hotspot settings by tapping the **Wi-Fi hotspot** option.



Your mobile operator will charge you based on your GPRS data usage.

---

## Pair With BT Devices

Go to  →  → **BT**.

To pair your A290 with some other BT device:

1. If BT is off, turn it on and then tap **BT**. Your phone scans and displays the BT devices in range.
2. Tap the ID of the other device in the list to pair with it.
3. You will be prompted to confirm passkey on both devices. Tap **Pair** to confirm the passkey and pair the devices. On successful pairing, your phone connects to the device.



If the device you want to pair with is not in the list, make it discoverable and then search. If your phone stops scanning before you make the other device discoverable, tap **SEARCH FOR DEVICES**.





Tap **Micromax A290** at the top of the scanned device list to make your A290 visible on other devices.

---

## Configuring E-Mail

You can check and reply to your emails from your A290 from anywhere and anytime. Apart from the Gmail account, you can configure other accounts too on this device.

To set up an email account:

1. Go to  →  → **Add account** → **Corporate**.
2. Type the email address and password in the respective fields and tap **Next**.
3. Set account settings, as required and tap **Next**.
4. Provide your account name and your name and then



tap **Next** to successfully finish account configuration.

The server will check for online settings automatically and your account will be set up. If not, please check your Internet settings before proceeding.



Tap the  button of the phone and then tap **Refresh** to refresh your emails manually.

---

## Google™ Maps

Google™ Maps is a web based service offered by Google Inc. which offers you access to various map-based services. You can view various streets, landmarks and can even plan your routes with the help of Google™ Maps. It comes with a navigation system (GPS required) which gives step-by-step route guidance while driving or walking. You can even download maps for offline usage. This serves as a useful application for your day-to-day usage.

Settings required for Google™ map access include:

- Enable location access from  →  → **Location**.

Go to  →  to start using Google™ Maps.



Internet connection is required for using Google™ Maps. When you use the map, you use your Internet connection to transfer data to and from your phone.

---



The Google™ Maps application may not be available in every street, country or region.

---





Micromax does not guarantee the accuracy of any directional services.

---

## Manage Applications

Your phone comes with a host of applications to make your life easier and more convenient. The Android phones offer users access to unlimited entertainment sources. You can download applications, games, movies, and books from the ever increasing Android market. New items get added almost daily to the market to give users a never ending fun experience.

To view and manage the list of all inbuilt, downloaded, and running applications, go to  →  → **Apps**.

To download applications, games, movies, and books from the Android Market, go to  →  to access the Google™ Android Market. View the details and download items, as desired.



Not all items are free of cost in the Android Market.

---



You need to enable internet connection and configure Google™ account on your device to get access to the Android Market.

---

## Safety Precautions



Remember to comply with legal requirements and local restrictions when using the phone.



Your Phone's radio waves may interfere with inadequately shielded medical devices. Consult a physician or manufacturer of the medical device to know whether they are adequately shielded from external Radio Frequency. Switch off your device when regulations require you to do so.

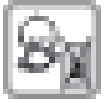

Always keep the phone and accessories out of reach of small children. Small parts such as the SIM card, dust cap, lens ring and lens cap as well as the micro SD card can be dismantled and swallowed by small children.



Do not place the phone near electromagnetic data carriers such as credit/Debit cards. Information stored on them could be lost.



Permanent hearing loss may occur if you use earphones at high volume for prolonged periods. Set your volume to a safe level. If you experience discomfort in your ears, reduce the volume or discontinue the use of your earphones.



Ring tones, info tones and hands-free talking are reproduced through the loudspeaker. Do not hold the phone to the ear when it rings or when you have switched on the hands-free function.



The mains voltage (V) specified on the power supply unit must not be exceeded to prevent damage to the charging device. The power supply must be plugged into an easily accessible AC power socket when charging the battery.



You may only open the phone to replace the battery, SIM and micro SD card. You must not open the battery under any circumstances. All other changes to this device are strictly prohibited and will invalidate the warranty.



The phone may cause interference in the vicinity of TV sets, radios and PCs.

Only use Micromax specified batteries and charging devices.



All batteries can cause property damage, injury or burns if a conductive material taps the exposed terminals. Exercise care in handling any charged battery, particularly when placing it inside your pocket, purse or other container with metal objects. Do not dispose of batteries in fire as they may explode.

Do not use the phone while driving. When you have to use the phone, please use the personal hands-free kit.



Please put the phone safely in the phone stand. Do not put it onto any passenger seat or any place from which it may fall down in case of vehicular collision or emergency braking.



Flight is influenced by interference caused by the phone. It is illegal to use a phone on the airplane. Please turn off your phone during a flight.



Professional service: The phone must be installed or repaired by Micromax authorized personnel. You are likely to suffer a huge risk when you install or repair this phone by yourself, which also goes against the warranty rules.

## Taking Care of your device

Your device is a product of superior design and craftsmanship and should be handled with care. The following suggestions will help you protect your phone.

- Keep the device dry. Precipitation, humidity, and all types of liquids or moisture can rust the electronic circuits. If your device gets wet, remove the battery, wipe it with a dry cloth and take it to an authorized service center.
- Do not store the device in high or cold temperature. High temperatures can shorten the life of electronic devices and damage batteries.
- Do not use or store the device in dusty, dirty areas. Its moving parts

and electronic components can get damaged.

- Do not attempt to open the device other than as instructed in this guide. Repairing this phone by yourself other than our authorized service agents/centers goes against the warranty rules.
- Do not drop, knock, or shake the device. Rough handling can break internal circuit boards and fine mechanics.
- Do not use harsh chemicals, cleaning solvents, or strong detergents to clean the device. Only use a soft, clean, dry cloth to clean the surface of the device.
- Do not store your device near magnetic fields or allow your device to come in contact with magnetic fields for extended period of time.

## Battery Recommendations

- Please put the battery in a cool and well-ventilated place out of direct sunlight. We recommend you to charge the battery at room temperature range.
- Batteries have life cycles. If the time that the battery powers equipment becomes much shorter than usual, the battery life is at an end. Replace the battery with a new battery of the same make and specification.
- Use manufacturer approved batteries, chargers, accessories and supplies. Micromax will not be held responsible for user's safety when using unapproved accessories or supplies.
- Do not discard the battery with household trash. Please dispose of used battery according to your local environmental laws and guidelines.

## Recycle your Phone

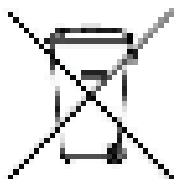

The WEEE logo (shown at the left) appears on the product (battery, handset, and charger) to indicate that this product must not be disposed off or dumped with your other household wastes. You are liable to dispose of all your

electronic or electrical waste equipment by relocating over to the specified collection point for recycling of such hazardous waste.

Collection and proper recovery of your electronic waste equipments at the time of disposal will allow us to help preserve the environment. Recycling of the electronic waste equipment will ensure safety of human health and environment. For more information on best practices for disposal of electronic and electrical waste, please visit to our web site: [www.micromaxinfo.com/weee.php](http://www.micromaxinfo.com/weee.php).

**Note:** Micromax will not bear any responsibility for any incompliance with the above mentioned guidelines or improper usage of the mobile phone.

## Copyright

All rights reserved. Reproduction, transfer, distribution or storage of part or all of the contents in this document in any form without the prior written permission of Micromax is strictly prohibited.