

SAMSUNG

SM-P550

User Manual

Table of Contents

Read me first

Getting started

- 6 Package contents
- 7 Device layout
- 9 S Pen
- 12 Charging the battery
- 14 Using a memory card
- 15 Turning the device on and off
- 16 Locking and unlocking the screen

Basics

- 17 Using the touch screen
- 20 Home screen layout
- 24 Notifications panel
- 27 Opening apps
- 27 Installing or uninstalling apps
- 29 Entering text
- 31 Screen capture
- 31 My Files
- 32 Power saving feature

Network connectivity

- 33 Wi-Fi

S Pen features

- 34 Air command
- 35 Action memo
- 37 Smart select
- 38 Image clip
- 39 Screen write
- 40 S Note
- 44 Scrapbook
- 45 Using the S Pen

Motions & usability features

- 48 Motions and gestures
- 49 Multi window

Personalising

- 54 Managing the Home and Apps screens
- 55 Setting wallpaper and ringtones
- 56 Changing the screen lock method

- 57 Private mode
- 59 Multiple users
- 60 Setting up accounts

Contacts

- 61 Adding contacts
- 62 Importing and exporting contacts
- 62 Searching for contacts

Camera

- 63 Basic shooting
- 64 Shooting modes
- 66 Camera settings

Gallery

- 67 Viewing content on the device

Useful apps and features

- 68 S Finder
- 68 S Planner
- 70 Email
- 72 Internet
- 73 Music
- 74 Video
- 75 Clock
- 77 Calculator
- 77 Smart Manager
- 78 Google apps

Connecting with other devices

- 81 Bluetooth
- 83 Wi-Fi Direct
- 85 Quick Connect
- 86 SideSync 3.0
- 93 Screen Mirroring
- 95 Mobile printing

Device & data manager

- 96 Transferring data from your previous device
- 98 Using the device as a removable disk for data transfer
- 98 Updating the device
- 99 Backing up and restoring data
- 100 Performing a data reset

Settings

- 101 About Settings
- 101 Connections
- 103 Device
- 105 Personal
- 109 System

Appendix

- 112 Troubleshooting
- 117 Removing the battery (non-removable type)

Read me first

Please read this manual before using the device to ensure safe and proper use.

- Descriptions are based on the device's default settings.
- Some content may differ from your device depending on the region, service provider, or device's software.
- Content (high quality content) that requires high CPU and RAM usage will affect the overall performance of the device. Apps related to the content may not work properly depending on the device's specifications and the environment that it is used in.
- Samsung is not liable for performance issues caused by apps supplied by providers other than Samsung.
- Samsung is not liable for performance issues or incompatibilities caused by edited registry settings or modified operating system software. Attempting to customise the operating system may cause the device or apps to work improperly.
- Software, sound sources, wallpapers, images, and other media provided with this device are licensed for limited use. Extracting and using these materials for commercial or other purposes is an infringement of copyright laws. Users are entirely responsible for illegal use of media.
- Default apps that come with the device are subject to updates and may no longer be supported without prior notice. If you have questions about an app provided with the device, contact a Samsung Service Centre. For user-installed apps, contact service providers.
- Modifying the device's operating system or installing softwares from unofficial sources may result in device malfunctions and data corruption or loss. These actions are violations of your Samsung licence agreement and will void your warranty.

Instructional icons



Warning: situations that could cause injury to yourself or others



Caution: situations that could cause damage to your device or other equipment



Note: notes, usage tips, or additional information

Getting started

Package contents

Check the product box for the following items:

- Device
- Quick start guide



- The items supplied with the device and any available accessories may vary depending on the region or service provider.
- The supplied items are designed only for this device and may not be compatible with other devices.
- Appearances and specifications are subject to change without prior notice.
- You can purchase additional accessories from your local Samsung retailer. Make sure they are compatible with the device before purchase.
- Use only Samsung-approved accessories. Using unapproved accessories may cause the performance problems and malfunctions that are not covered by the warranty.
- Availability of all accessories is subject to change depending entirely on manufacturing companies. For more information about available accessories, refer to the Samsung website.



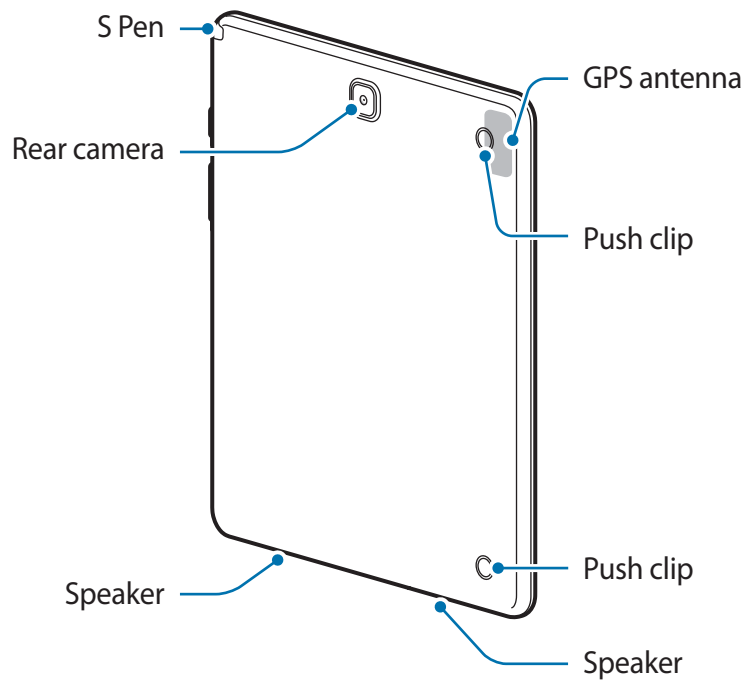
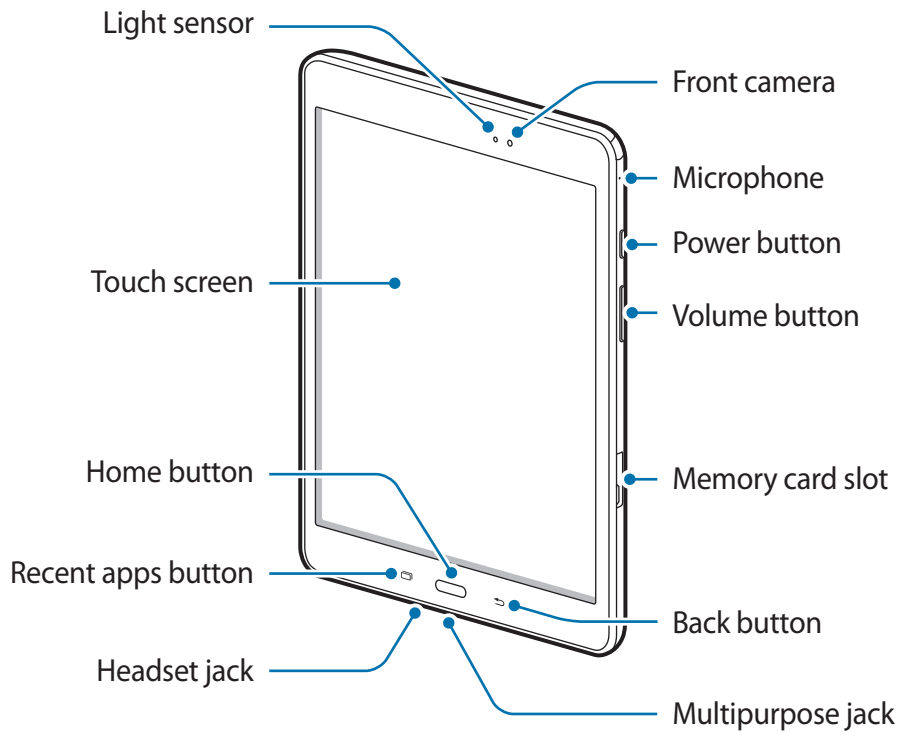

Device layout





- Do not cover the antenna area with your hands or other objects. This may cause connectivity problems or drain the battery.
- Using a Samsung-approved screen protector is recommended. Unapproved screen protectors may cause the sensors to malfunction.
- Do not allow water to contact the touch screen. The touch screen may malfunction in humid conditions or when exposed to water.

Buttons

Button	Function
 Power	<ul style="list-style-type: none"> • Press and hold to turn the device on or off. • Press to turn on or lock the screen.
 Recent apps	<ul style="list-style-type: none"> • Tap to open the list of recent apps. • Tap and hold to launch the split screen view.
 Home	<ul style="list-style-type: none"> • Press to turn on the screen while the screen is locked. • Press to return to the Home screen. • Press and hold to launch Google.
 Back	<ul style="list-style-type: none"> • Tap to return to the previous screen.
 Volume	<ul style="list-style-type: none"> • Press to adjust the device volume.

S Pen

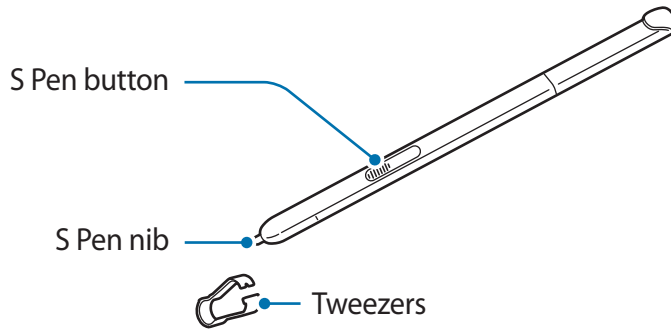

Name	Functions
S Pen nib	<ul style="list-style-type: none"> • Use the S Pen to write, draw, or perform touch actions on the screen. • Hover the S Pen over items on the screen to access additional S Pen features, such as Air Button and the air view feature.
S Pen button	<ul style="list-style-type: none"> • Hover the S Pen over the screen and press the S Pen button to display the air command features. • While pressing and holding the S Pen button, drag the S Pen over items to select them.
Tweezers	<ul style="list-style-type: none"> • Remove the S Pen nib with the tweezers when replacing the nib.

Removing the S Pen

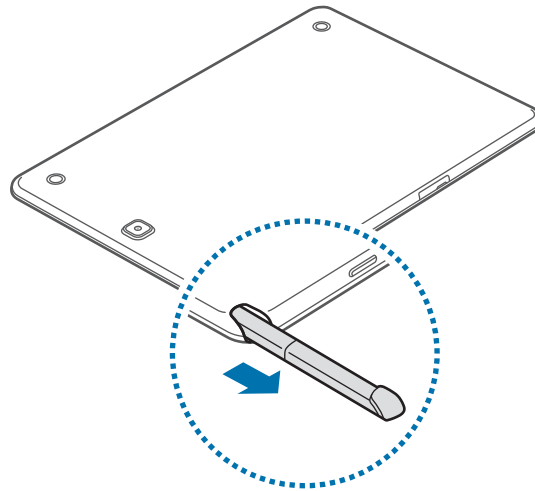

When you remove the S Pen from the slot, the device launches **Air command** or displays the air command features depending on the S Pen detachment option setting.

To change the setting, open the Apps screen and tap **Settings** → **S Pen** → **Detachment options**.

Replacing the S Pen nib

If the nib is dull, replace it with a new one.

- 1 Firmly hold the nib with the tweezers and remove it.

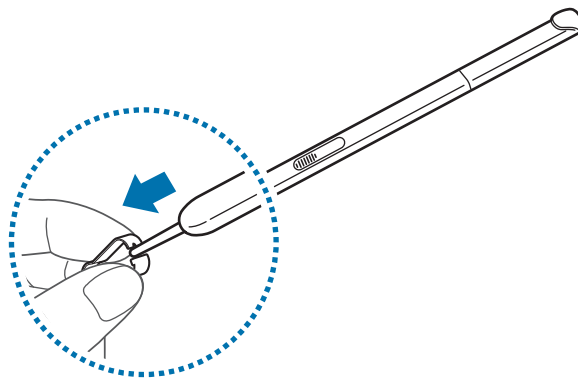

2 Insert a new nib into the S Pen.

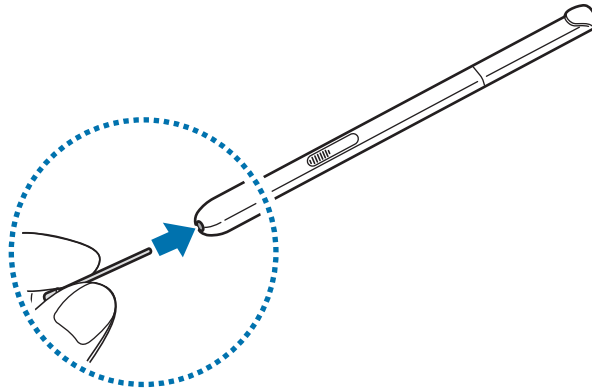

Be careful not to pinch your fingers with the tweezers.



- Do not reuse old nibs. Doing so may cause the S Pen to malfunction.
- Do not press the nib excessively when inserting the nib into the S Pen.
- Do not insert the round end of the nib into the S Pen. Doing so may cause damage to the S Pen or your device.



- If the S Pen is not working properly, take it to a Samsung Service Centre. For more information about the S Pen, visit the Samsung website.
- If you use the S Pen at sharp angles on the screen, the device may not recognise the S Pen actions. Do not bend or apply excessive pressure with the S Pen while using it.
- The Recent apps button and the Back button can be used with the S Pen.

Charging the battery

Use the charger to charge the battery before using it for the first time. A computer can be also used to charge the battery by connecting them via the USB cable.



Use only Samsung-approved chargers, batteries, and cables. Unapproved chargers or cables can cause the battery to explode or damage the device.



- When the battery power is low, the battery icon appears empty.
- If the battery is completely discharged, the device cannot be turned on immediately when the charger is connected. Allow a depleted battery to charge for a few minutes before turning on the device.
- If you use multiple apps at once, network apps, or apps that need a connection to another device, the battery will drain quickly. To avoid disconnecting from the network or losing power during a data transfer, always use these apps after fully charging the battery.

- 1 Connect the USB cable to the USB power adaptor and then plug the end of the USB cable into the multipurpose jack.

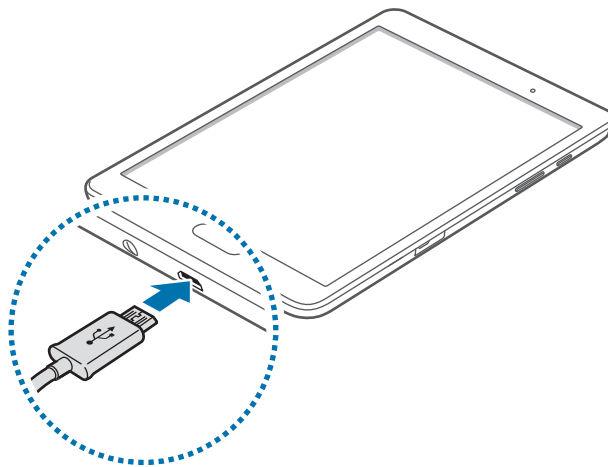

Connecting the charger improperly may cause serious damage to the device. Any damage caused by misuse is not covered by the warranty.

2 Plug the USB power adaptor into an electric socket.



- The device can be used while it is charging, but it may take longer to fully charge the battery.
- If the device receives an unstable power supply while charging, the touch screen may not function. If this happens, unplug the charger from the device.
- While charging, the device may heat up. This is normal and should not affect the device's lifespan or performance. If the battery gets hotter than usual, the charger may stop charging.
- If the device is not charging properly, take the device and the charger to a Samsung Service Centre.

3 After fully charging, disconnect the device from the charger. First unplug the charger from the device, and then unplug it from the electric socket.



To save energy, unplug the charger when not in use. The charger does not have a power switch, so you must unplug the charger from the electric socket when not in use to avoid wasting power. The charger should remain close to the electric socket and easily accessible while charging.

Reducing the battery consumption

Your device provides options that help you save the battery power. By customising these options and deactivating features in the background, you can use the device longer between charges:

- Optimise the device using the Smart manager.
- When you are not using the device, switch to sleep mode by pressing the Power button.
- Close unnecessary apps using the task manager.
- Deactivate the Bluetooth feature.
- Deactivate the Wi-Fi feature.
- Deactivate auto-syncing of apps.
- Decrease the backlight time.
- Decrease the screen brightness.

Using a memory card

Installing a memory card

Your device accepts memory cards with maximum capacities of 128 GB. Depending on the memory card manufacturer and type, some memory cards may not be compatible with your device.



- Some memory cards may not be fully compatible with the device. Using an incompatible card may damage the device or the memory card, or corrupt the data stored in it.
- Use caution to insert the memory card right-side up.



- The device supports the FAT and the exFAT file systems for memory cards. When inserting a card formatted in a different file system, the device asks to reformat the memory card.
- Frequent writing and erasing of data shortens the lifespan of memory cards.
- When inserting a memory card into the device, the memory card's file directory appears in the **My Files** → **SD card** folder.

- 1 Open the cover of the memory card slot.
- 2 Insert a memory card with the gold-coloured contacts facing downwards.

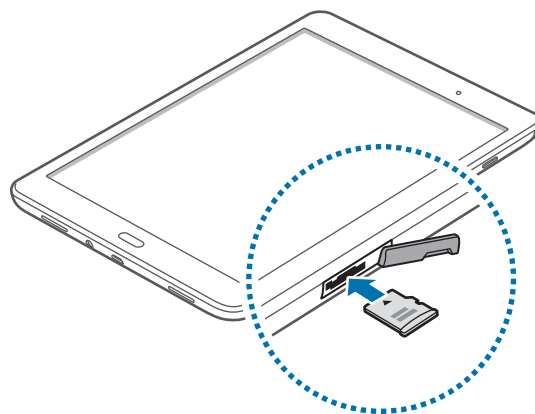

- 3 Push the memory card into the slot until it locks in place.
- 4 Close the cover of the memory card slot.

Removing the memory card

Before removing the memory card, first unmount it for safe removal. On the Home screen, tap **Apps** → **Settings** → **Storage** → **Unmount SD card**.

- 1 Open the cover of the memory card slot.
- 2 Push the memory card until it disengages from the device, and then pull it out.
- 3 Close the cover of the memory card slot.



Do not remove the memory card while the device is transferring or accessing information. Doing so can cause data to be lost or corrupted or can damage the memory card or device. Samsung is not responsible for losses that result from the misuse of damaged memory cards, including the loss of data.

Formatting the memory card

A memory card formatted on a computer may not be compatible with the device. Format the memory card on the device.

On the Home screen, tap **Apps** → **Settings** → **Storage** → **Format SD card** → **FORMAT SD CARD** → **ERASE EVERYTHING**.



Before formatting the memory card, remember to make backup copies of all important data stored in the device. The manufacturer's warranty does not cover loss of data resulting from user actions.

Turning the device on and off

Press and hold the Power button for a few seconds to turn on the device.

When you turn on your device for the first time or after performing a data reset, follow the on-screen instructions to set up your device.

To turn off the device, press and hold the Power button, and then tap **Power off**.



Follow all posted warnings and directions from authorised personnel in areas where the use of wireless devices is restricted, such as aeroplanes and hospitals.

Locking and unlocking the screen

Pressing the Power button turns off the screen and locks it. Also, the screen turns off and automatically locks if the device is not used for a specified period.

To unlock the screen, press the Power button or the Home button and flick your finger in any direction within the unlock screen area.

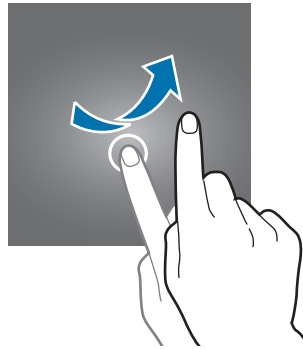

You can change the unlock code to unlock the screen. Refer to [Changing the screen lock method](#) for more information.

Basics

Using the touch screen



- Do not allow the touch screen to come into contact with other electrical devices. Electrostatic discharges can cause the touch screen to malfunction.
- To avoid damaging the touch screen, do not tap it with anything sharp or apply excessive pressure to it with your fingertips.



- The device may not recognise touch inputs close to the edges of the screen, which are outside of the touch input area.
- Leaving the touch screen idle for extended periods may result in afterimages (screen burn-in) or ghosting. Turn off the touch screen when you do not use the device.

Tapping

To open an app, to select a menu item, to press an on-screen button, or to enter a character using the keyboard on the screen, tap it with a finger or the S Pen.

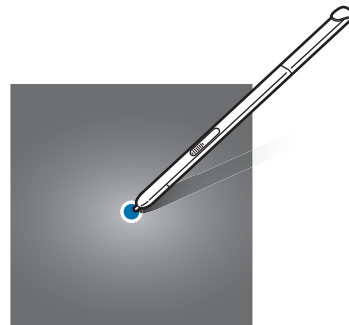
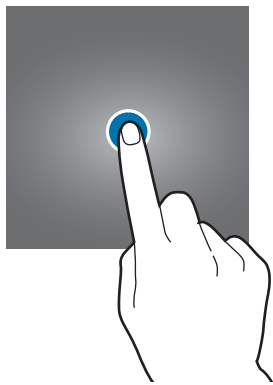

Tapping and holding

Tap and hold an item or the screen for more than 2 seconds to access available options.

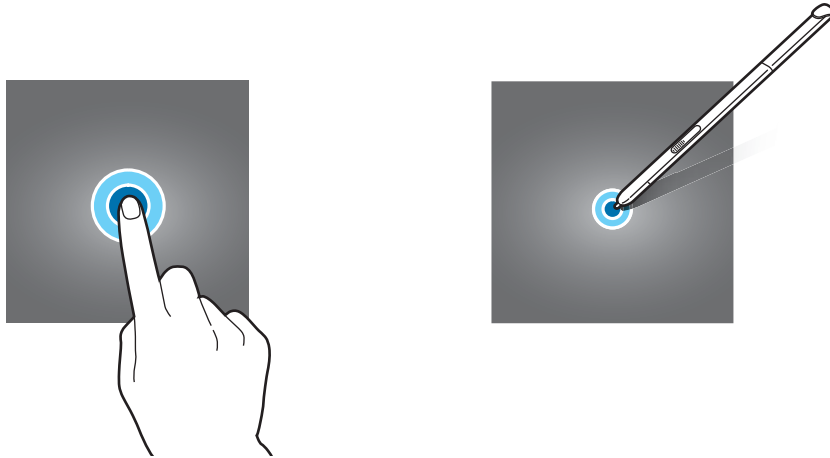

Dragging

To move an item, tap and hold it and drag it to the target position.

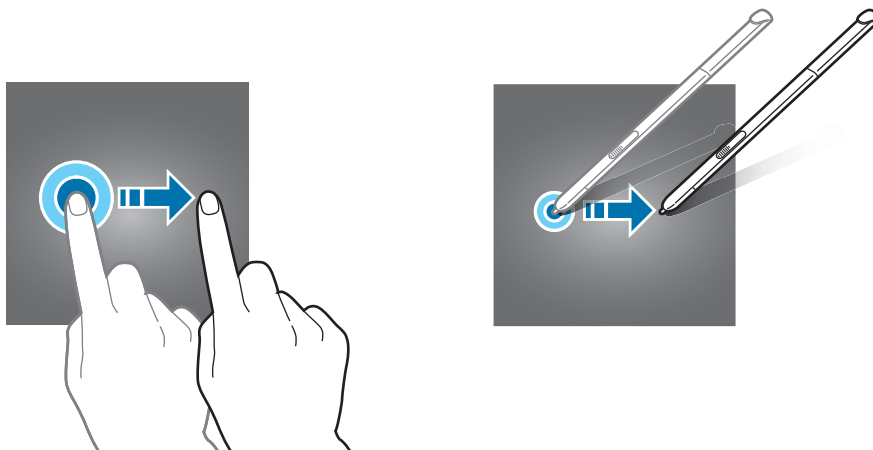

Double-tapping

Double-tap on a webpage or image to zoom in. Double-tap again to return.

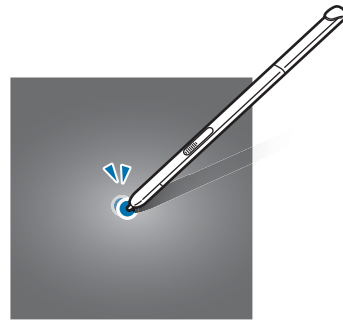
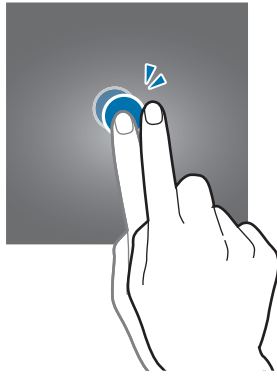

Flicking

Flick left or right on the Home screen or the Apps screen to see another panel. Flick up or down to scroll through a webpage or a list of items, such as contacts.

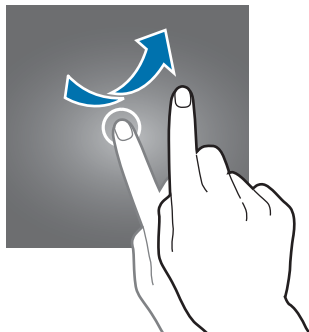

Spreading and pinching

Spread two fingers apart on a webpage, map, or image to zoom in a part. Pinch to zoom out.

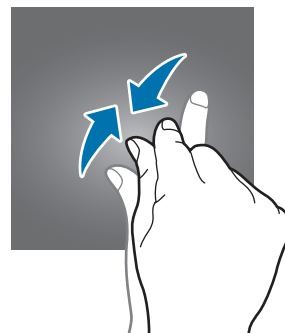
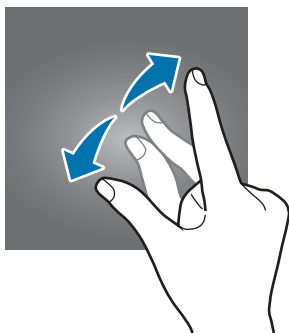

Home screen layout

Home screen

The Home screen is the starting point for accessing all of the device's features. It displays widgets, shortcuts to apps, and more. Widgets are small apps that launch specific app functions to provide information and convenient access on your Home screen.

To view other panels, scroll left or right, or tap one of the screen indicators at the bottom of the screen. To customise the Home screen, refer to [Managing the Home screen](#).

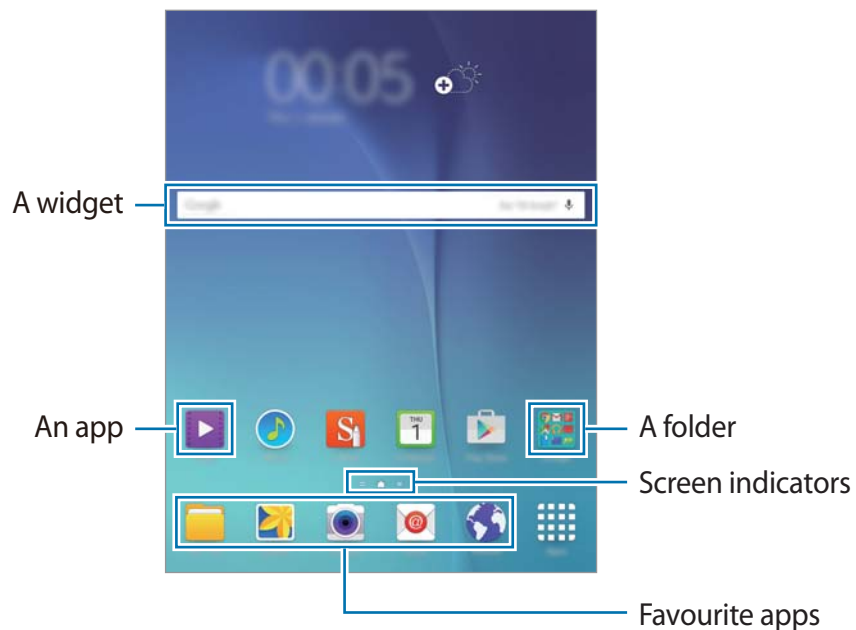

Home screen options

On the Home screen, tap and hold an empty area, or pinch your fingers together to access the available options.

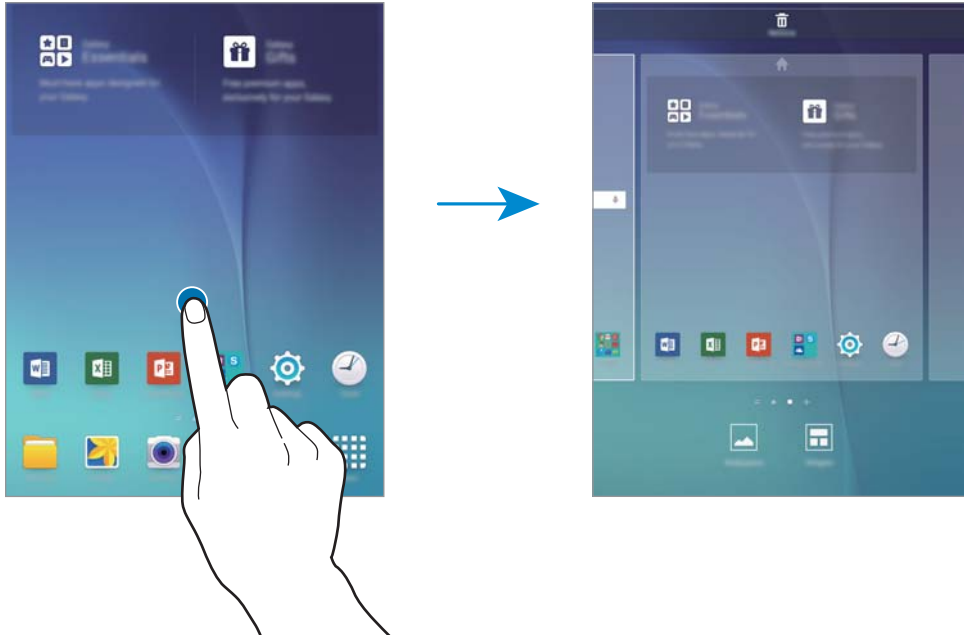

Apps screen

The Apps screen displays icons for all apps, including newly installed apps.

On the Home screen, tap **Apps** to open the Apps screen. To view other panels, scroll left or right, or select a screen indicator at the bottom of the screen. To customise the Apps screen, refer to [Managing the Apps screen](#).

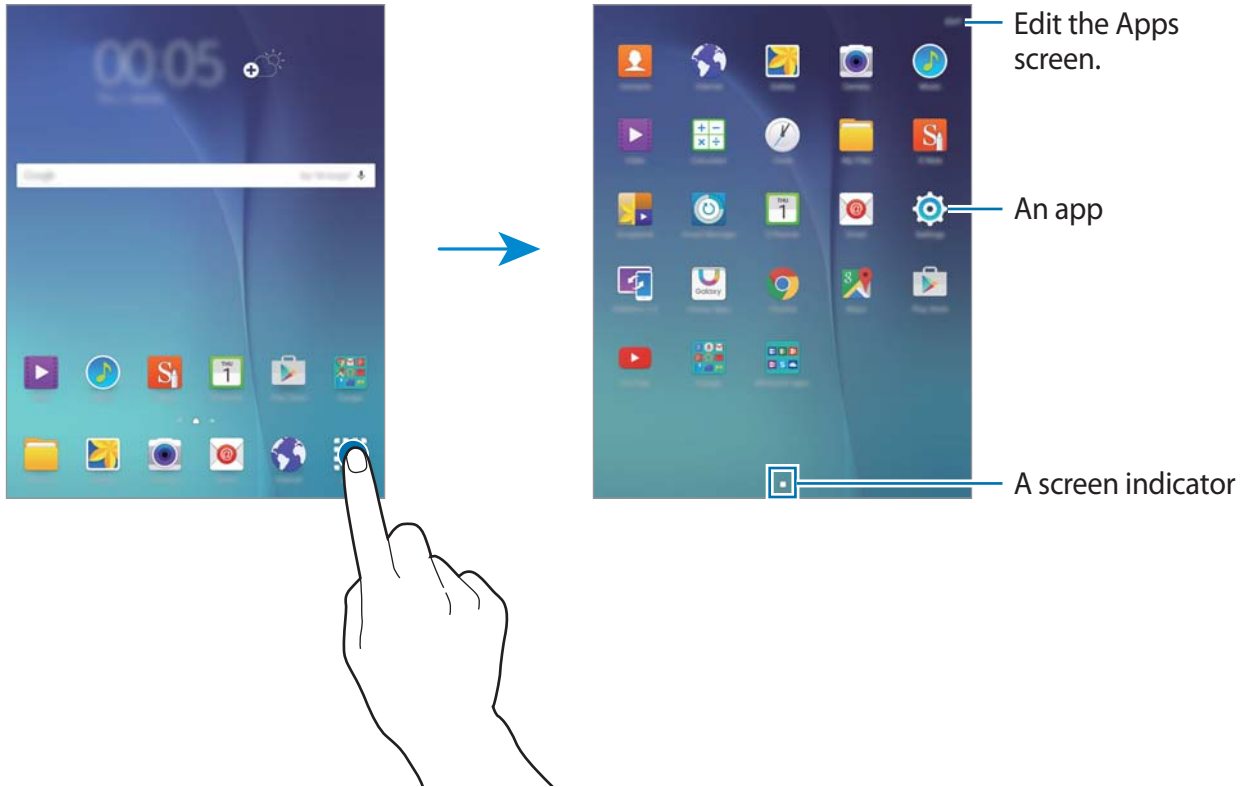











Indicator icons

Indicator icons appear on the status bar at the top of the screen. The icons listed in the table below are most common.



The status bar may not appear at the top of the screen in some apps. To display the status bar, drag down from the top of the screen.

Icon	Meaning
	Wi-Fi connected
	Bluetooth feature activated
	GPS activated
	Synced with the web
	Alarm activated
	S Pen detached
	Mute mode activated
	Flight mode activated
	Error occurred or caution required
	Battery power level

Notifications panel

Using the notifications panel

When you receive new notifications, such as messages, indicator icons appear on the status bar. To see more information about the icons, open the notifications panel and view the details.

To open the notifications panel, drag the status bar downwards. To close the notifications panel, drag the bar from the bottom of the screen upwards.

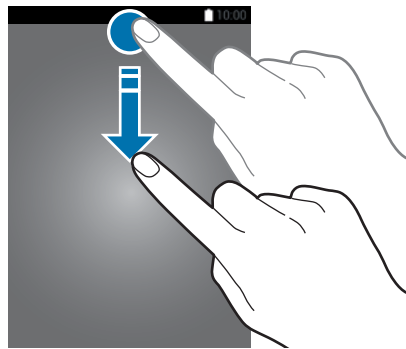

You can use the following functions on the notifications panel.

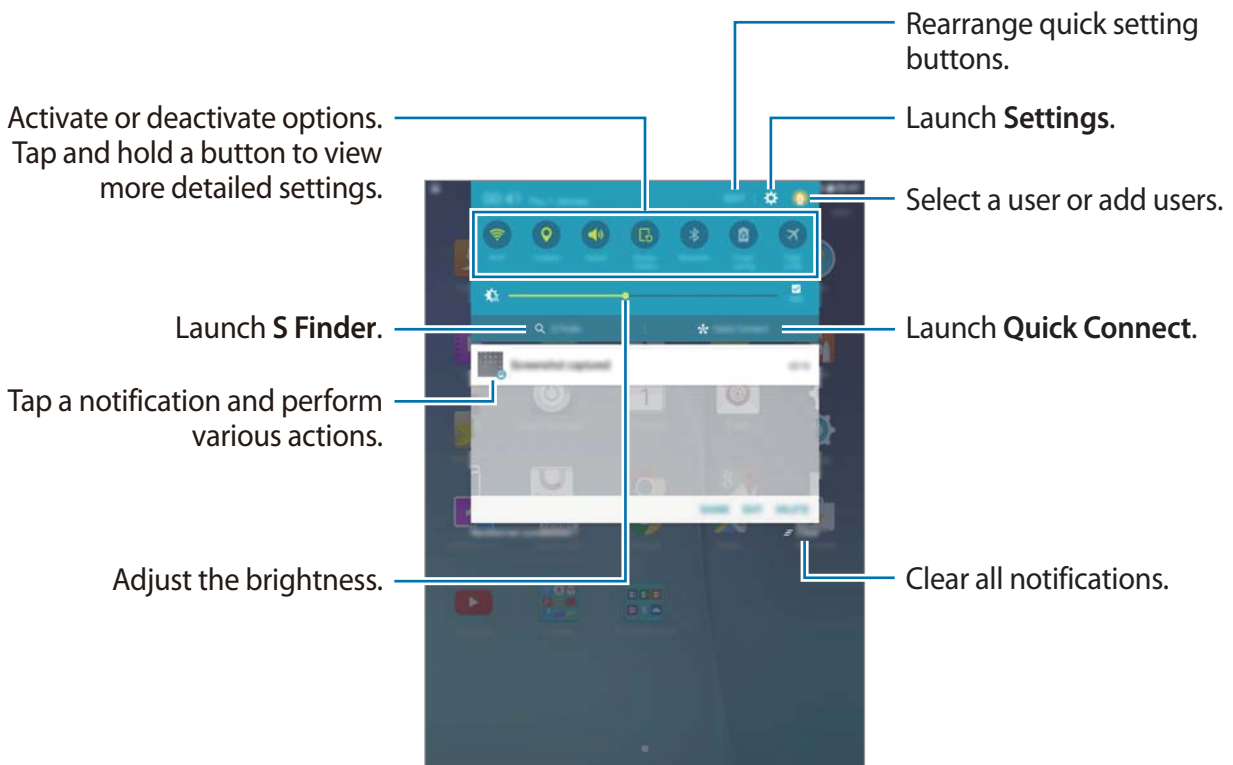

Rearranging quick setting buttons

To rearrange quick setting buttons on the notifications panel, tap **EDIT**, tap and hold an item, drag the item to another location, and then tap **DONE**.

Using the quick setting buttons

You can activate or deactivate some features on the notifications panel. Tap the following options to activate or deactivate them. You can view more detailed settings if you tap and hold a button.

- **Wi-Fi:** Refer to [Wi-Fi](#) for more information.
- **Location:** Activate or deactivate the GPS feature.
- **Sound / Mute:** Select a sound mode.
- **Screen rotation:** Allow or prevent the interface from rotating when you rotate the device.



Some apps do not allow screen rotation.

- **Bluetooth:** Refer to [Bluetooth](#) for more information.
- **Power saving:** Refer to [Power saving feature](#) for more information.
- **Flight mode:** Refer to [Flight mode](#) for more information.
- **Do not disturb:** Activate or deactivate blocking mode. In blocking mode, the device will block notifications. To select which notifications will be blocked, tap **Settings** → **Sounds and notifications** → **Do not disturb**.
- **Reading mode:** Activate or deactivate reading mode. In reading mode, the device helps protect your eyes when reading at night.
- **U. power saving:** Refer to [Ultra power saving mode](#) for more information.
- **Smart stay:** When you activate this feature, the screen stays on as long as you look at it.
- **Private mode:** Refer to [Private mode](#) for more information.
- **Screen Mirroring:** Refer to [Screen Mirroring](#) for more information.
- **Sync:** When you activate this feature, the device automatically syncs apps, such as calendar or email.

Opening apps

On the Home screen or the Apps screen, select an app icon to open it.

To open the list of recently-used apps, tap  and select an app icon to open.

Closing an app

Tap  and drag an app icon to the left or right to close it. To close all running apps, tap **CLOSE ALL**.

Installing or uninstalling apps

Samsung Galaxy Apps

Use this app to purchase and download apps.

Tap **Galaxy Apps** on the Apps screen.



This app may not be available depending on the region or service provider.

Installing apps

Browse apps by category or tap **SEARCH** to search for a keyword.

Select an app to view information about it. To download free apps, tap **Install**. To purchase and download apps where charges apply, tap the button that shows the app's price.



To change the auto update settings, tap  → **Settings** → **Auto update apps**, and then select an option.

Play Store

Use this app to purchase and download apps.

Tap **Play Store** on the Apps screen.

Installing apps

Browse apps by category or tap  to search for a keyword.

Select an app to view information about it. To download free apps, tap **INSTALL**. To purchase and download apps where charges apply, tap the price and follow the on-screen instructions.



To change the auto update settings, tap  → **Settings** → **Auto-update apps**, and then select an option.

Managing apps

Uninstalling or disabling apps

To disable default apps, open the Apps screen and tap **EDIT**.  appears on the apps that you can disable. Select an app and tap **DISABLE** → **DONE**.

To uninstall downloaded apps, open the Apps screen and tap **EDIT** →  → **UNINSTALL** → **DONE**. Alternatively, on the Apps screen, tap **Settings** → **Applications** → **Application manager**, select an app, and then tap **UNINSTALL**.

Enabling apps

On the Apps screen, tap **Settings** → **Applications** → **Application manager**, scroll to **DISABLED**, select an app, and then tap **ENABLE**.



- Disabling apps: Disable selected default apps that cannot be uninstalled from the device. You cannot use disabled apps.
- Uninstalling apps: Uninstall downloaded apps.

Entering text

Keyboard layout



A keyboard appears automatically when you enter text to send messages, create memos, and more.



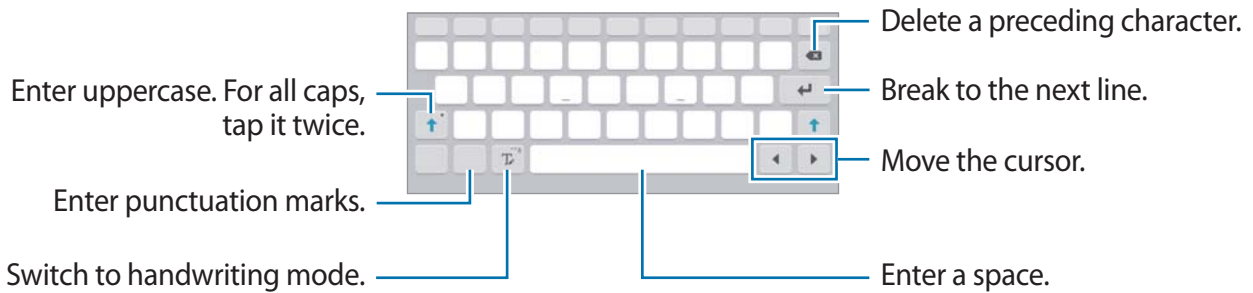

Text entry is not supported in some languages. To enter text, you must change the input language to one of the supported languages.



Changing the input language

Tap and hold , tap  → **Select input languages**, and then select the languages to use. If you select two or more languages, you can switch between the input languages by sliding the space key left or right.

Using additional keyboard functions

Tap and hold  to use various functions. Other icons may appear instead of  depending on the last function that was used.



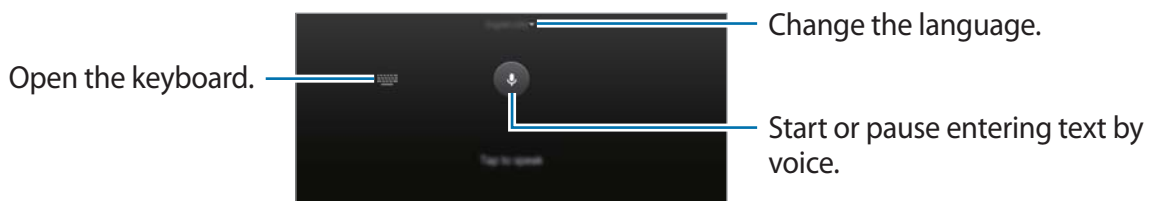

-  : Enter text by voice.

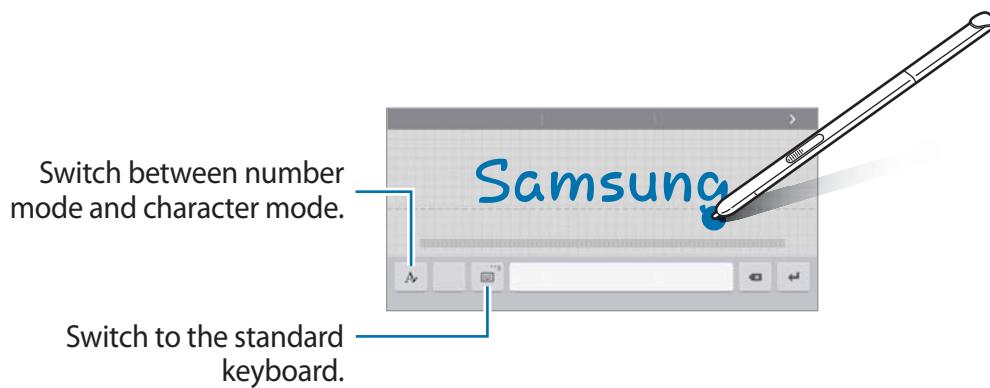





-  : Switch to handwriting mode.



This feature may not be available depending on the region or service provider.

-  : Add an item from the clipboard.
-  : Enter emoticons.
-  : Switch to the floating or split keyboard.
-  : Change the keyboard settings.

Copying and pasting

- 1 Tap and hold over text.
- 2 Drag  or  to select the desired text, or tap **Select all** to select all text.
- 3 Tap **Copy** or **Cut**. The selected text is copied to the clipboard.
- 4 Place the cursor where the text is to be inserted and tap  → **Paste**. To paste text that you have previously copied, tap  → **Clipboard** and select the text.

Screen capture

Capture a screenshot while using the device.

Press and hold the Home button and the Power button simultaneously. You can view captured images in **Gallery**. After capturing a screenshot, you can edit the image and share it with others.

You can also capture screenshots using other methods. Refer to [Palm swipe to capture](#) for more information.



It is not possible to capture a screenshot while using some apps.

My Files

Use this app to access various files stored in the device or in other locations, such as cloud storage services.

Tap **My Files** on the Apps screen.

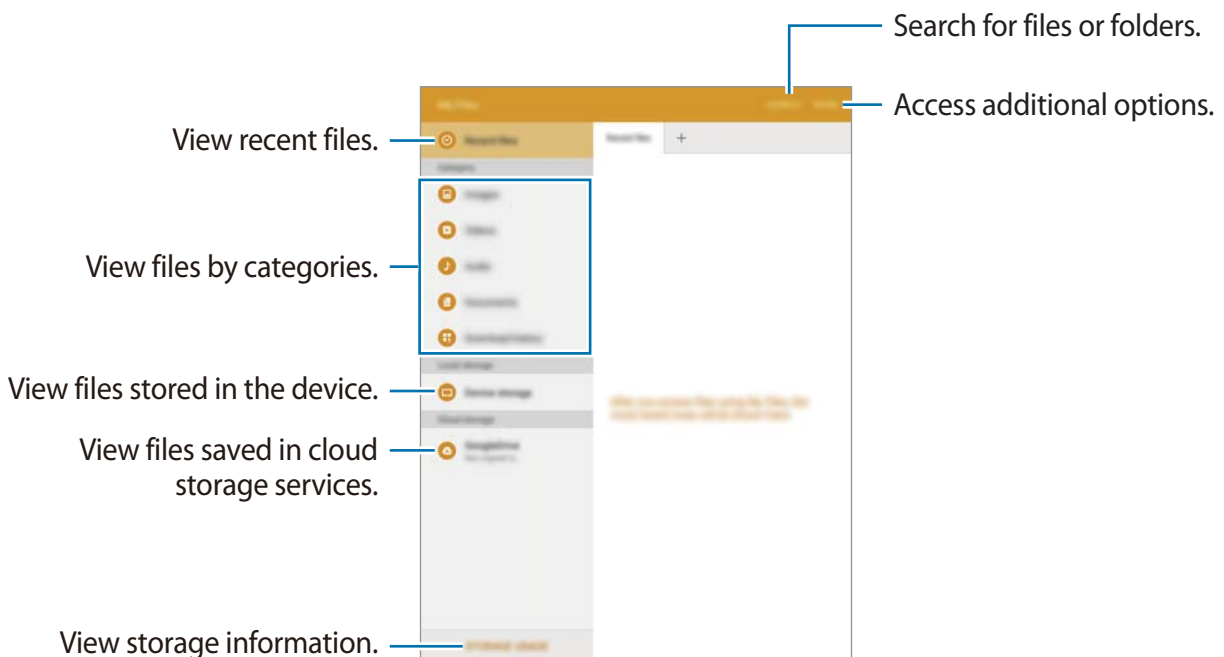

Power saving feature

Power saving mode

Save the battery power by limiting the device's functions.

On the Apps screen, tap **Settings** → **Battery** → **Power saving mode**, and then tap the switch to activate it.

To automatically activate power saving mode when the remaining battery power reaches the preset level, tap **Start power saving** and select an option.

Ultra power saving mode

Use this mode to extend the device's battery power. In ultra power saving mode, the device performs the following:

- Restricts the available apps to essential and selected apps only.
- Deactivates the Bluetooth feature.

On the Apps screen, tap **Settings** → **Battery** → **Ultra power saving mode**, and tap switch to activate it.

To add an app to the Home screen, tap ⊕ and select an app.

To remove an app from the Home screen, tap **MORE** → **Remove**, select an app with ⊖, and then tap **DONE**.

To change the settings for ultra power saving mode, such as network connectivity or sound, tap **MORE** → **Settings**.

To deactivate ultra power saving mode, tap **MORE** → **Disable ultra power saving mode**.



The usage time left shows the time remaining before the battery power runs out. Usage time left may vary depending on your device settings and operating conditions.

Network connectivity

Wi-Fi

Connect the device to a Wi-Fi network to use the Internet or share media files with other devices. Refer to [Wi-Fi](#) for additional options.



- Your device uses a non-harmonised frequency and is intended for use in all European countries. The WLAN can be operated in the EU without restriction indoors, but cannot be operated outdoors.
- Turn off Wi-Fi to save the battery when not in use.

- 1 On the Apps screen, tap **Settings** → **Wi-Fi**, and then tap the switch to activate it.
- 2 Select a network from the Wi-Fi networks list. Networks that require a password appear with a lock icon.
- 3 Tap **CONNECT**.



Once the device connects to a Wi-Fi network, the device will reconnect to that network each time it is available without requiring a password. To prevent the device connecting to the network automatically, select it from the list of networks and tap **FORGET**.

S Pen features

Air command

Remove the S Pen from the slot, or hover the S Pen over any part of the screen and press the S Pen button to access four useful features.



If this feature is not activated, open the Apps screen, tap **Settings** → **S Pen** → **Air command**, and then tap the **Air command** switch to activate it.

With the air command features, you can perform various actions.

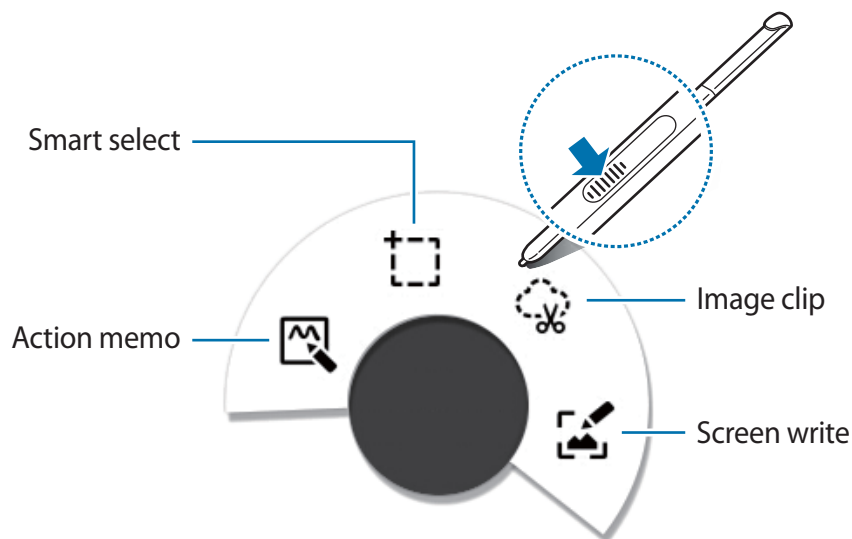

- **Action memo:** Write memos quickly and link actions to them. You can send messages, search the web, and more. Refer to [Action memo](#) for more information.
- **Smart select:** Collect content quickly. Refer to [Smart select](#) for more information.
- **Image clip:** Draw around an area of the screen you want to save or share. Refer to [Image clip](#) for more information.
- **Screen write:** Capture, edit, and write memos on screenshots, and then share them. Refer to [Screen write](#) for more information.

Action memo

Open the Action memo pad and create memos to perform various actions using the written or drawn information.

1 On the air command panel, tap **Action memo**.

2 Write or draw a memo.

3 Tap .

The entire memo will be selected. If you want to use specific information from the memo, tap the outside of the selected area to deselect the memo and draw around the information to use it.

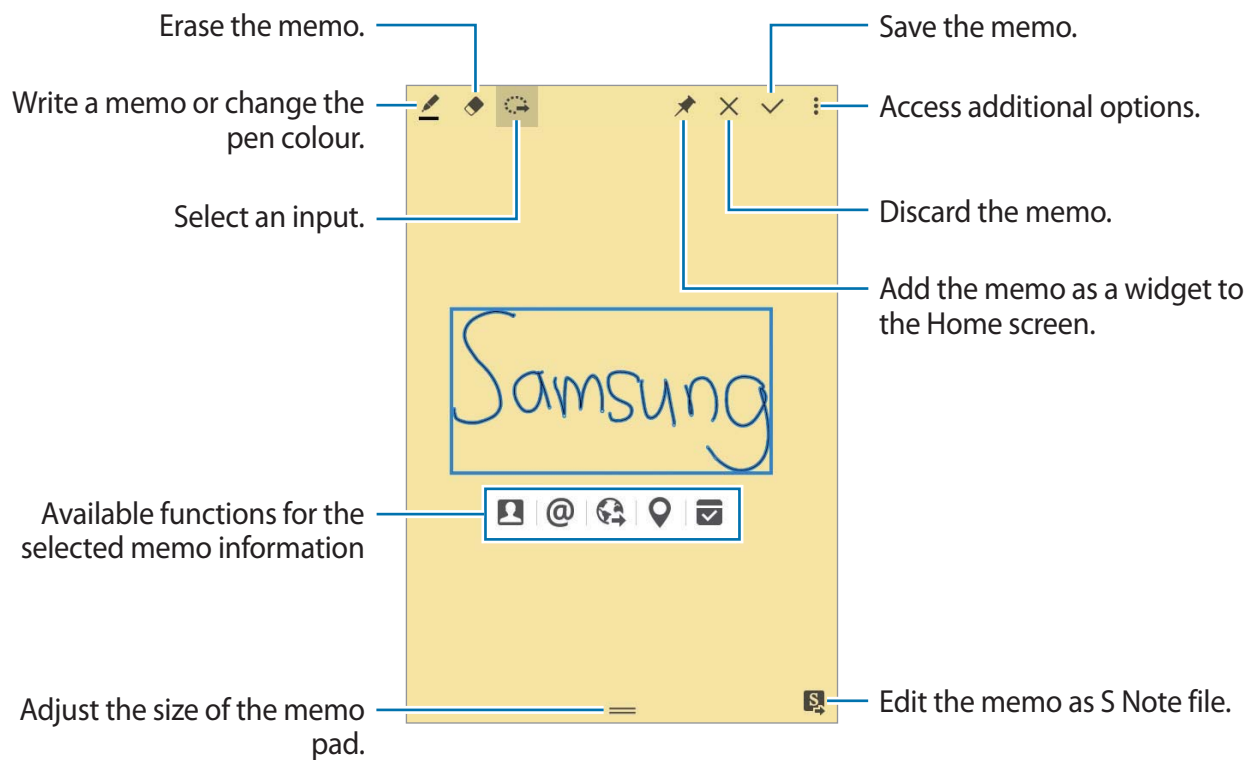

4 Select an app to use with the selected memo information.

The selected app will launch from **Action memo**.

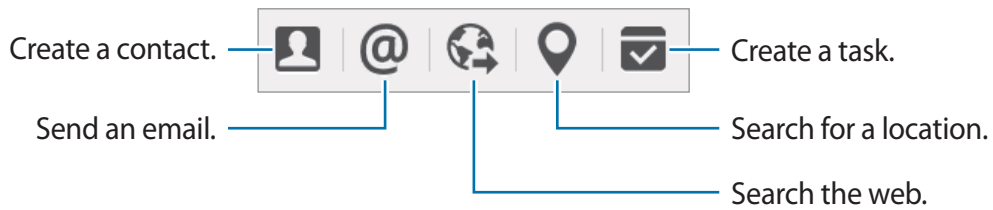

Viewing memos

On the Action memo screen, tap → **View action memo list**. Select a memo to view and edit it.

Adding Action memo widgets on the Home screen

After composing a memo, tap and hold , and then drag the memo to an empty area on the Home screen. An **Action memo** widget is added to the Home screen and you can view and edit the memo.

Editing a memo as S Note file

While composing a memo, tap to open **S Note** and edit the memo in it. The same pen colour that you were using in **Action memo** will be applied in **S Note**.

Smart select

Collect the desired area of content appearing on the screen with the S Pen. You can collect content from webpages or music and videos during playback.

- 1 When there is content you want to collect, such as a part of a webpage, open the air command panel and tap **Smart select**.
- 2 Drag the S Pen across the content you want to collect.

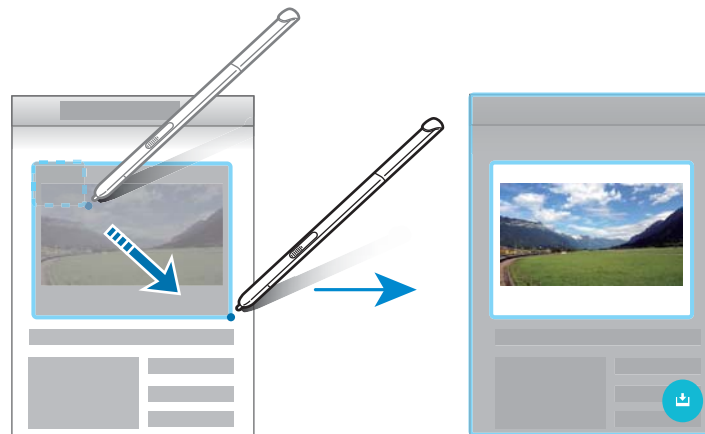

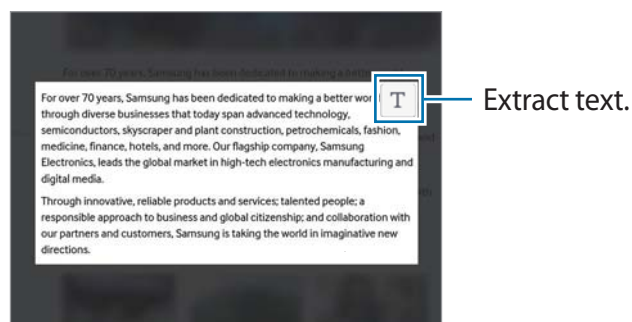

- 3 Select an option to use with the collected item.

- **SAVE:** Save the item in **Scrapbook**.
- **SHARE:** Share the item with others.
- **T:** Extract text from the item. You can copy the extracted text to the clipboard or insert it into messages, notes, and more.



-  : Save the item in the collected items list to collect more content.

Collecting multiple items

Tap  to add content to your collected items list to use it later. To collect additional content, tap  on the collected items pop-up window.

To view collected items, tap the collected items pop-up window. You can share, delete, or save multiple items at once. To individually select an item in the collected items list, tap and hold an item.

To delete the collected items, tap and hold the collected items list pop-up window, and then drag it to **Delete** at the top of the screen.

Image clip

Use the S Pen to draw a closed shape around the area you want to save or share. You can crop part of an image.

- 1 When there is content you want to capture, such as a part of an image, open the air command panel and tap **Image clip**.
- 2 Draw around an area to select it with the S Pen.
Reshape the selected area by selecting a shape icon on the toolbar, or tap  to automatically reshape the selected area.

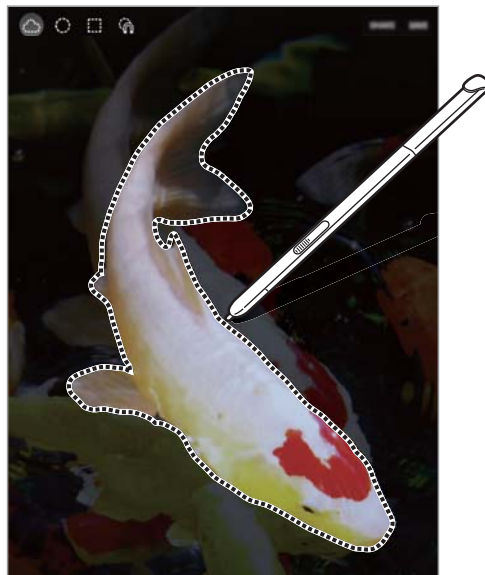

- 3 Select an option to use with the selected area.
 - **SAVE:** Save the selected area in **Scrapbook**.
 - **SHARE:** Share the selected area with others.

Screen write

Capture screenshots to write or draw on them.

- 1 When there is content you want to capture, such as a part of a webpage, open the air command panel and tap **Screen write**.

The current screen is automatically captured and the editing toolbar appears on the screen.

- 2 Write a memo on the screenshot.

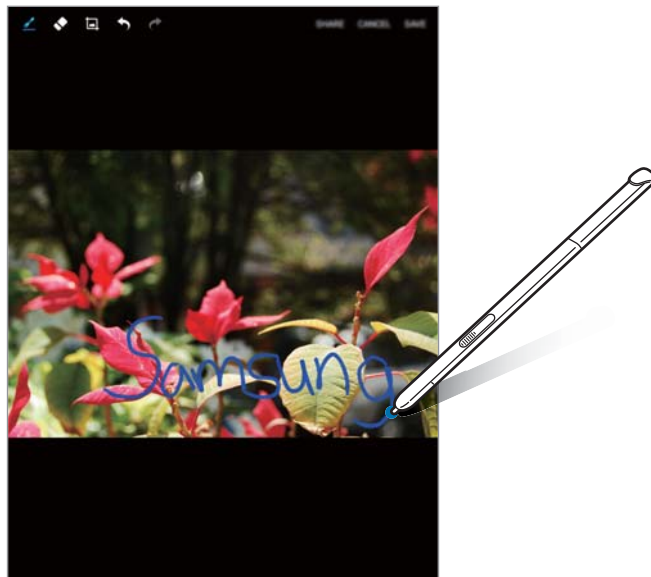

- 3 Select an option to use with the screenshot.
 - **SHARE:** Share the screenshot with others.
 - **SAVE:** Save the screenshot. You can view captured images in **Gallery**.



It is not possible to capture a screenshot while using some apps.

S Note

Create custom notes by recording your thoughts and ideas. You can insert multimedia files and create Photo notes.

Starting S Note

- 1 Tap **S Note** on the Apps screen.
Alternatively, on the Home screen, tap  in the **S Note** widget.
- 2 Select cover styles and tap **NEXT**.
- 3 Select a default note template and tap **NEXT**.
- 4 Select an account to sync your notes with and tap **START**.
If you are not signed in to the selected account, follow the on-screen instructions to sign in to the account.
If you sync your notes with an account, you can view them on other devices by registering the account on other devices.

Using the S Note widget

You can launch some S Note features directly from the **S Note** widget.

On the Home screen, tap an icon in the **S Note** widget.

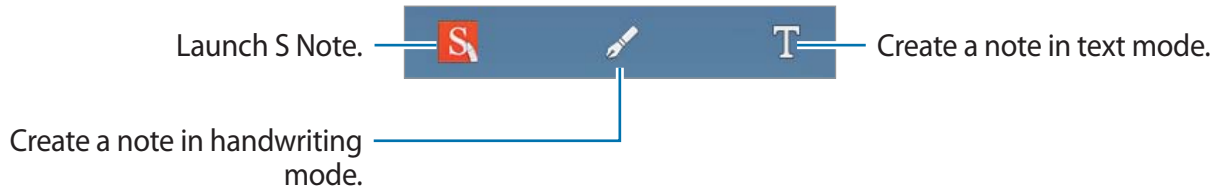

Creating notes

1 Tap **S Note** on the Apps screen.

Alternatively, on the Home screen, tap **S** in the **S Note** widget.

2 Tap **+**.

3 Compose a note.

Tap **✎** to write or draw on the screen, or tap **T** to enter text using the keyboard.

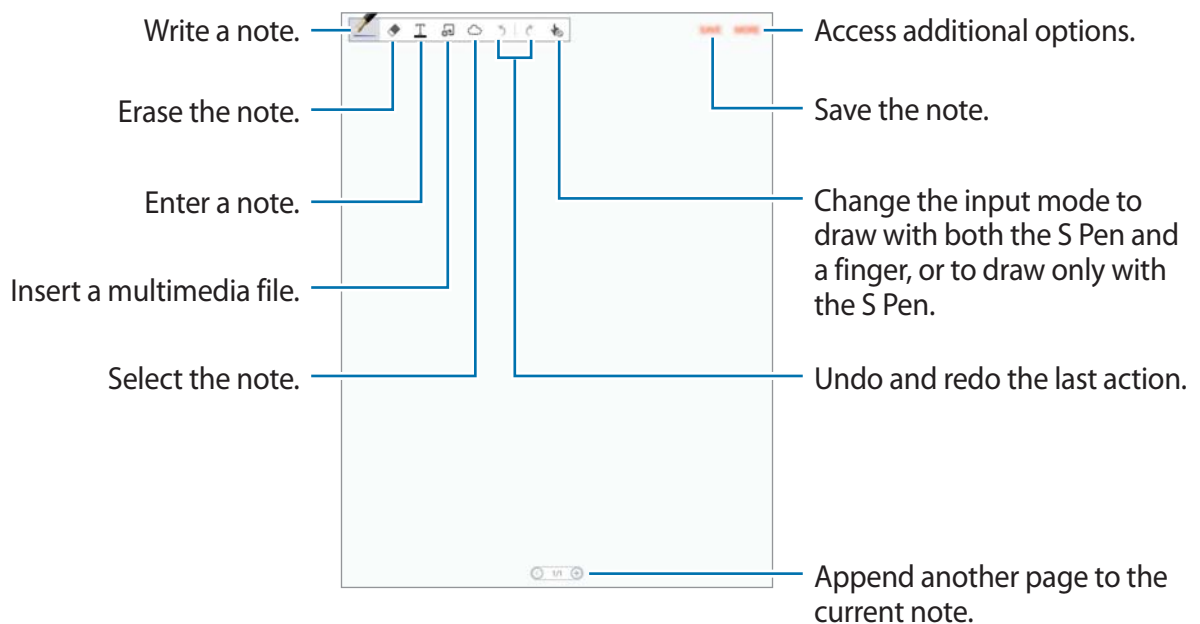

Changing the pen settings

When writing or drawing on the screen, tap  once more to change the pen type, line thickness, or pen colour.

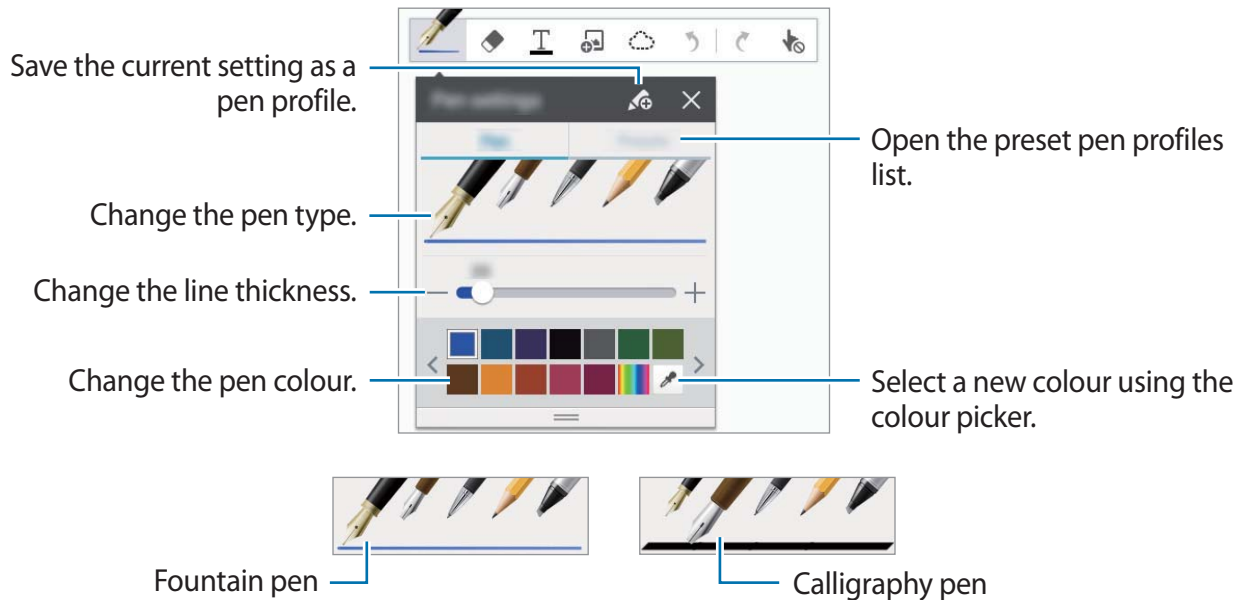

Using the line eraser

1 Tap .

2 Tap an area to erase.

The whole line on the area will be erased. The line eraser can erase your S Note line by line.

- To only erase the area you touch with the S Pen, tap  once more and deselect **Erase line by line**. You can adjust the size of the eraser by dragging the size adjustment bar.
- To clear the note, tap **ERASE ALL**.



Even with a smaller eraser, you may still not be able to precisely erase the intended part.

Editing handwritten notes

Edit handwritten notes using various editing options, such as cutting, moving, resizing, or transforming.

1 When there is handwriting or a drawing on the note, tap .

2 Tap or draw a line around the input to select and edit it.

To move the input to another location, select the input, and then drag it to a new location.

To resize the input, select the input and drag the frame handle.

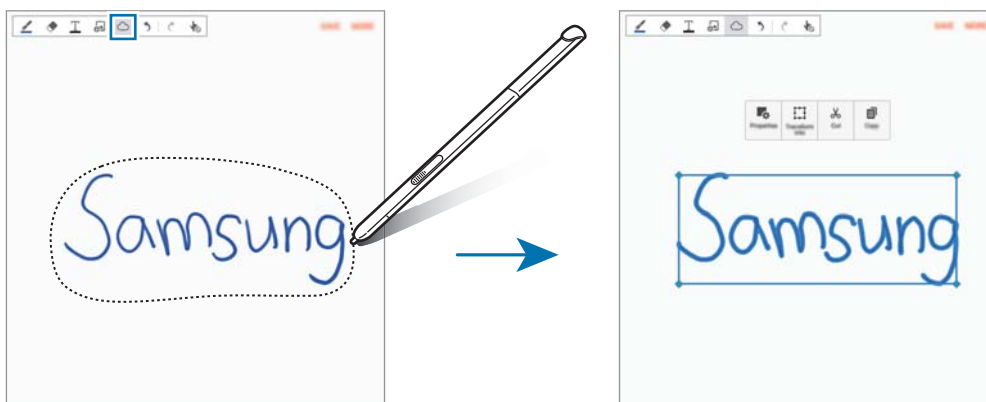

3 Use one of the following options:



- **Properties:** Change the input properties, such as layout, size, colour, or thickness.
- **Transform into:** Refine or convert handwriting or drawings.
- **Cut:** Cut out the input. To paste it to another location, tap and hold the location, and then tap **Paste**.
- **Copy:** Copy the input. To paste it to another location, tap and hold the location, and then tap **Paste**.

Magnified handwriting mode

Tap **MORE** → **Show Magnified note** and drag the magnifier frame to an area. The area in the magnifier frame appears in the magnified window at the bottom of the screen. You can precisely enter or correct the handwriting.

Sketch recording

You can record your actions while composing a note.

- 1 Tap **MORE** → **Record sketching**.
- 2 Tap  and write or draw a note.
Your actions are recorded in real time.
- 3 To stop recording, tap  again.
Tap  to view the recording.

Scrapbook

Collect content from various sources to create your own digital scrapbook. While viewing webpages or videos, you can select and add a desired area to scrapbooks.



This app may not be available depending on the region or service provider.

When you launch this app for the first time or restart it after performing a data reset, read and agree to the terms and conditions, and then set a sync option.

- 1 Tap **Scrapbook** on the Apps screen.
- 2 Tap  to select a category and select a scrapbook.
If there is a link below the scrapbook content, tap the link to go to the source.
- 3 Tap **EDIT** to edit it.
You can add a title, text, memos, or tags to the scrapbook.
- 4 Tap **SAVE** to save the changes.

Using the S Pen

Write, draw, or perform touch actions with the S Pen. You can easily access additional features by pressing the S Pen button.

Air view

Hover over an item on the screen with the S Pen to perform various functions.



If this feature is not activated, open the Apps screen, tap **Settings** → **S Pen** → **Air view**, and then tap the **Air view** switch to activate it.

Previewing information

Point at the screen to preview content or view information in a pop-up window.

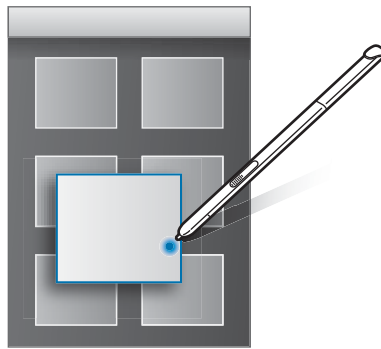

Using Air Button

Hovering the S Pen over items in some apps, such as **Gallery** and **Video**, will display Air Button on the preview window. You can perform various actions directly from the preview window using Air Button.

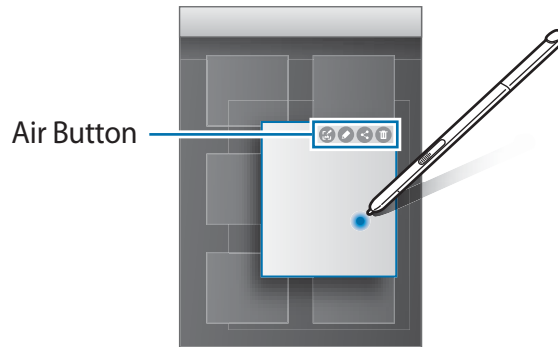

Pen Select

While pressing and holding the S Pen button, drag the S Pen over text or item lists to select multiple items or text. You can also copy and paste the selected items or text into another app or share them with others.

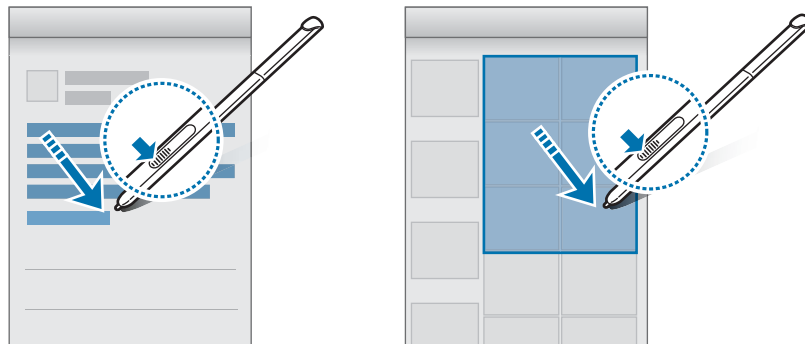

Direct pen input

Fill in forms and write messages using your handwriting with the S Pen.



If this feature is not activated, open the Apps screen, tap **Settings** → **S Pen** → **Direct pen input**, and then tap the switch to activate it.

Writing in text fields

- 1 Hover the S Pen over a text field.
- 2 Tap  to open the handwriting field.

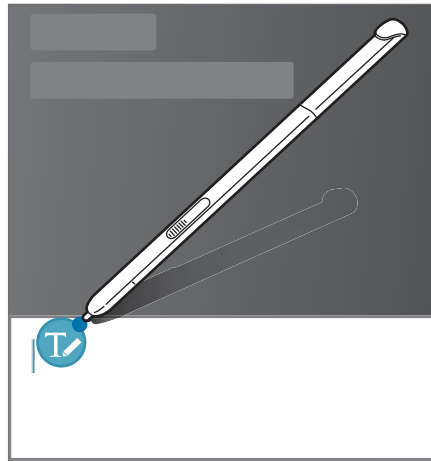

- 3 Write with the S Pen.
- 4 When you are finished, tap .

Writing in apps

You can write directly on the screen with the S Pen when using some features and apps. For example, you can enter numbers on the dialling keypad or set an alarm time by writing on the handwriting field with the S Pen.

Motions & usability features

Motions and gestures



Excessive shaking or impact on the device may result in unintended inputs. Control motions properly.

Mute

On the Apps screen, tap **Settings** → **Motions and gestures**, and then tap the **Mute** switch to activate it.

Cover the screen with your palm to mute alarms.

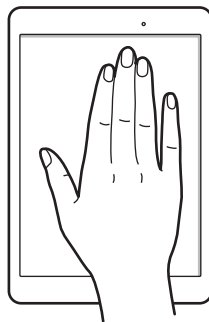

Palm swipe to capture

On the Apps screen, tap **Settings** → **Motions and gestures**, and then tap the **Palm swipe to capture** switch to activate it.

Place the side of your hand on the screen and sweep it across the screen from the right to the left or vice versa to capture a screenshot. You can view captured images in **Gallery**. After capturing a screenshot, you can edit the image and share it with others.



It is not possible to capture a screenshot while using some apps.

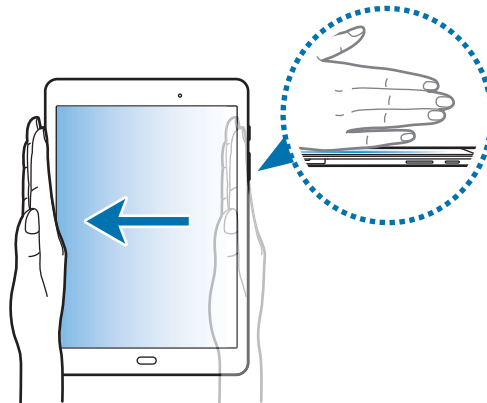

Multi window



About Multi window

Multi window lets you run two apps at the same time in the split screen view. You can also run multiple apps at the same time in the pop-up view.



Some apps may not support this feature.

Split screen view

- 1 Tap  to open the list of recently used apps.
- 2 Swipe upwards or downwards and tap  on a recent app window.
The selected app will launch in the upper window.

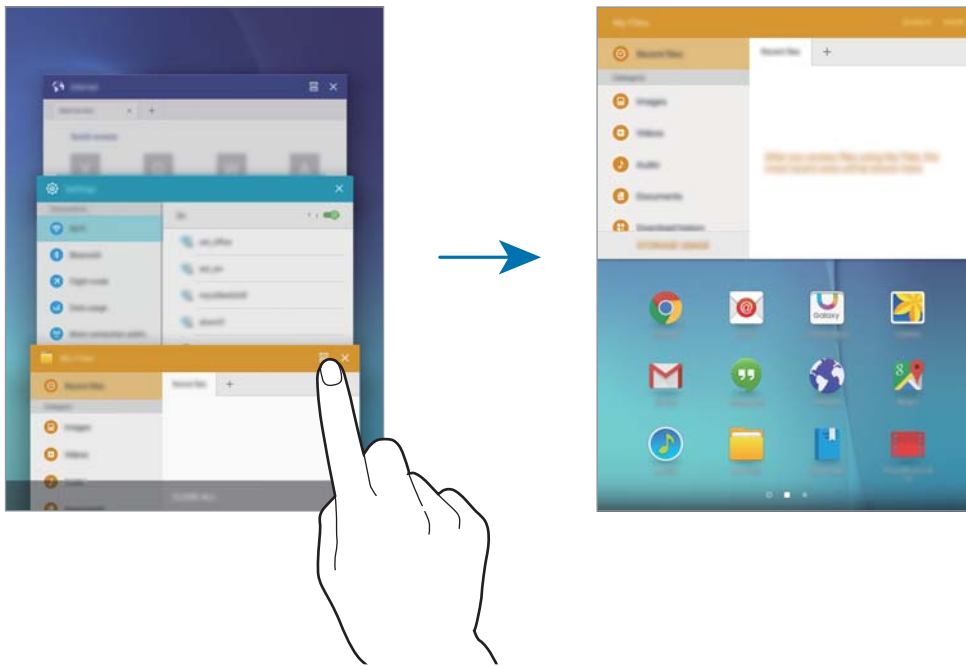

- 3 Select another app to launch.





You can also launch the split screen view by tapping and holding .

Using additional options

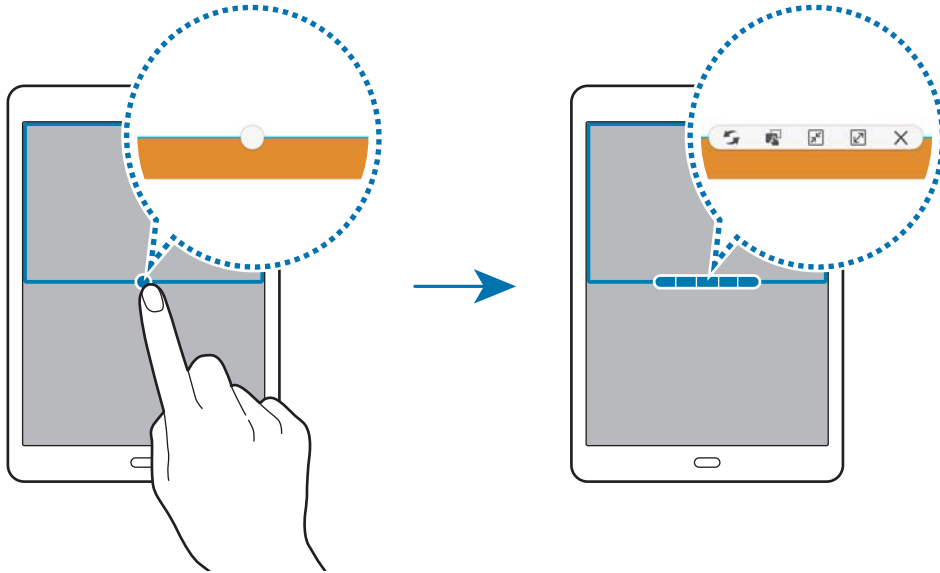

When using apps in the split screen view, select an app window and tap the circle between the app windows to access the following options:



-  : Switch locations between app windows.
-  : Drag and drop text or copied images from one window to another. Tap and hold an item in the selected window and drag it to a location in another window.



Some apps may not support this feature.

-  : Minimise the window.
-  : Maximise the window.
-  : Close the app.

Adjusting the window size

Drag the circle between the app windows up or down to adjust the size of the windows.

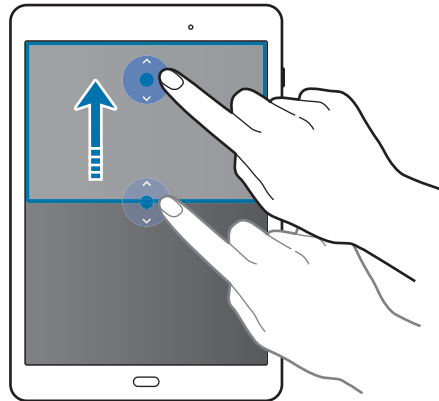

Pop-up view

- 1 On the Apps screen, launch an app to use in the pop-up view.
- 2 Drag down diagonally from either end of the top edge.
The app screen will appear in the pop-up view.

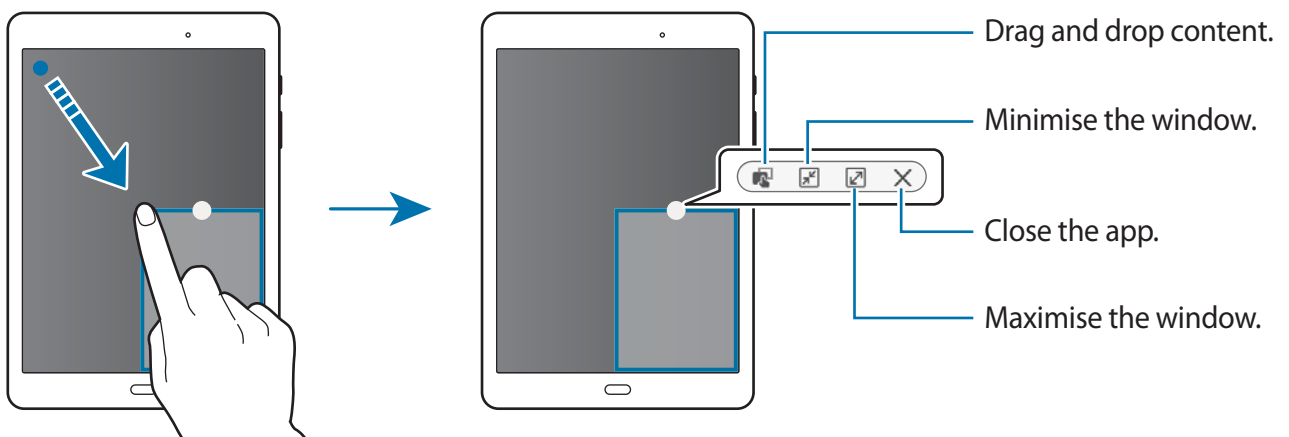

Moving pop-up windows

To move a pop-up window, tap and hold the circle on a window and drag it to a new location.

Launching the pop-up view from the split screen view

- 1 On the split screen view, tap an app window to launch it in the pop-up view.
- 2 Tap and hold the circle between the app windows.
The selected app will launch in a pop-up window.

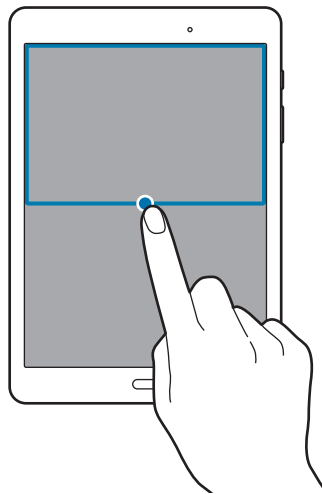

Personalising

Managing the Home and Apps screens

Managing the Home screen

Adding items

Tap and hold an app or a folder from the Apps screen, and then drag it to the Home screen.

To add widgets, open the Home screen, tap and hold an empty area, tap **Widgets**, tap and hold a widget, and then drag it to the Home screen.

Moving and removing an item

Tap and hold an item on the Home screen, and then drag it to a new location.

To move the item to another panel, drag it to the side of the screen.

You can also move frequently-used apps to the shortcuts area at the bottom of the Home screen.

To remove an item, tap and hold the item. Then, drag it to **Remove** that appears at the top of the screen.

Creating a folder

- 1 On the Home screen, tap and hold an app, and then drag it over another app.
- 2 Enter a folder name.
To add more apps to the folder, tap and hold another app, and then drag it to the folder.

Managing panels

On the Home screen, tap and hold an empty area to add, move, or remove a panel.

To add a panel, scroll left to the last panel, and then tap **+**.

To move a panel, tap and hold a panel preview, and then drag it to a new location.

To remove a panel, tap and hold a panel preview, and then drag it to **Remove** at the top of the screen.

To set a panel as the main Home screen, tap **🏠**.

Managing the Apps screen

Moving items

On the Apps screen, tap **EDIT**. Tap and hold an item and drag it to a new location.

To move the item to another panel, drag it to the side of the screen.

Setting wallpaper and ringtones

Setting wallpaper

Set an image or photo stored in the device as wallpaper for the Home screen or the locked screen.

- 1 On the Home screen, tap and hold an empty area, and then tap **Wallpapers**. Alternatively, on the Apps screen, tap **Settings** → **Wallpaper**.
- 2 Select a screen to change or apply wallpaper to.
- 3 Scroll left or right and select from images displayed at the bottom of the screen.
To select photos taken by the device's camera or other images, tap **From Gallery**.
- 4 Tap **SET AS WALLPAPER** or **DONE**.

Changing ringtones

Change ringtones for notifications.

On the Apps screen, tap **Settings** → **Sounds and notifications** → **Ringtones and sounds**, select a ringtone, and then tap **OK**.

Changing the screen lock method

You can change the way that you lock the screen to prevent others from accessing your personal information.

On the Apps screen, tap **Settings** → **Lock screen and security** → **Screen lock type**, and then select a screen lock method. The device requires an unlock code whenever unlocking it.



If the unlock code is forgotten, take the device to a Samsung Service Centre to reset it.

Pattern

Draw a pattern by connecting four dots or more, and then draw the pattern again to verify it. Set a backup PIN to unlock the screen when you forget the pattern.

PIN

A PIN consists of numbers only. Enter at least four numbers, and then enter the password again to verify it.

Password

A password consists of characters and numbers. Enter at least four characters including numbers and symbols, and then enter the password again to verify it.

Private mode

Hide personal content in your device to prevent others from accessing it.

In private mode, you can hide items in **Gallery**, **Video**, **Music**, **My Files**, **S Note**, and **Internet**.

Activating private mode

- 1 On the Apps screen, tap **Settings** → **Privacy** → **Private mode**, and then tap the switch to activate it.

If you are activating private mode for the first time, follow the on-screen instructions to set up a private mode access code.

- 2 Follow the on-screen instructions to enter the preset private mode access code.

Private mode is activated and  appears on the status bar.



You can view and access the hidden items only when private mode is activated. To hide items stored in the private folder, deactivate private mode.

Hiding content

- 1 On the Apps screen, launch an app to hide items.

- 2 Select an item and tap **MORE** → **Move to Private**.

If private mode is not activated, follow the on-screen instructions to enter the preset private mode access code.

The selected items will be moved to the private folder.

Viewing hidden content

You can view hidden items only when private mode is activated.

- 1 On the Apps screen, tap **Settings** → **Privacy** → **Private mode**, and then tap the switch to activate it.
- 2 Follow the on-screen instructions to enter the preset private mode access code.
- 3 On the Apps screen, tap **My Files** → **Private**.
Items moved to the private folder will appear on the screen. For bookmarks, you can view them with the **Internet** app.

Unhiding content

- 1 In the private folder, tap and hold an item, and then tick items to unhide.
- 2 Tap **MORE** → **Remove from Private**.
- 3 Select a folder to move the items to, and then tap **MOVE HERE**.
The items will be moved to the selected folder.

Automatically deactivating private mode

You can set the device to automatically deactivate private mode each time the screen turns off.

- 1 On the Apps screen, tap **Settings** → **Privacy** → **Private mode**, and then tap the switch to activate it.
- 2 Follow the on-screen instructions to enter the preset private mode access code.
- 3 Tap the **Auto disable** switch to activate it.



When the **Auto disable** option is enabled, the device will fail to transfer files to the private folder if the screen turns off during transfer.

Multiple users

Set up additional user accounts for other users to use the device with personalised settings, such as email accounts, wallpaper preferences, and more. Following types of user accounts are available.

- **Owner:** The owner account is created only when setting up the device for the first time, and cannot be created more than one. This account has full control of the device including user account management.
- **User:** This account allows users to access their own apps and content, and customise the device settings that affect all accounts.
- **Restricted profile:** A restricted account can only access the apps and content allowed by the owner account, and cannot use the services that require logging in.

Adding users

- 1 On the Apps screen, tap **Settings** → **Users**.
- 2 Tap **Add user or profile** → **User** → **OK** → **SET UP NOW**.
- 3 Follow the on-screen instructions to complete the account setup.

Adding restricted profile

- 1 On the Apps screen, tap **Settings** → **Users**.
- 2 Tap **Add user or profile** → **Restricted profile** → **SET UP SCREEN LOCK**.
- 3 Set an unlock code, and then select the apps and content that restricted users are allowed to access.

Switching users

- 1 On the Apps screen, tap **Settings** → **Users**.
- 2 Select the account to switch to, and then unlock the device.

Managing users

When using the owner account, you can delete accounts or change the settings for restricted accounts.

To change the settings, on the Apps screen, tap **Settings** → **Users** and tap  next to an account. Then, select or deselect apps and content to allow or restrict the account's access to them.

To delete the account, tap . To delete the restricted account, tap  → .

Setting up accounts

Adding accounts

Some apps used on your device require a registered account. Create accounts to have the best experience with your device.

On the Apps screen, tap **Settings** → **Accounts** → **Add account** and select an account service. Then, follow the on-screen instructions to complete the account setup.

To sync content with your accounts, select an account and select items to sync.

Removing accounts

On the Apps screen, tap **Settings** → **Accounts**, select an account, and then tap **MORE** → **Remove account**.





Contacts

Adding contacts

Moving contacts from other devices

You can move contacts from other devices to your device. Refer to [Transferring data from your previous device](#) for more information.

Creating contacts manually

- 1 On the Apps screen, tap **Contacts**.
- 2 Tap  and enter contact information.
 - : Add an image.
 -  / : Add or delete a contact field.
- 3 Tap **SAVE**.

Importing and exporting contacts

Import contacts from storage services to your device or export contacts from the device to storage services.

On the Apps screen, tap **Contacts**.

Tap **MORE** → **Settings** → **Manage & back up contacts** → **Import/Export contacts**, and then select an import or export option.



Searching for contacts

On the Apps screen, tap **Contacts**.

Use one of the following search methods:

- Scroll up or down the contacts list.
- Drag a finger along the index at the left side of the contacts list to scroll through it quickly.
- Tap the search field at the top of the contacts list and enter search criteria.

Once a contact is selected, take one of the following actions:

-  : Add to favourite contacts.
-  : Compose an email.

Adding shortcuts for contacts to the Home screen



Add shortcuts to contacts that you frequently communicate with on the Home screen.

- 1 On the Apps screen, tap **Contacts**.
- 2 Select a contact.
- 3 Tap **MORE** → **Add shortcut on home screen**.

Camera

Basic shooting

Taking photos or recording videos

- 1 Tap **Camera** on the Apps screen.
- 2 Tap the image on the preview screen where the camera should focus.
- 3 Tap  to take a photo or tap  to record a video.
 - Spread two fingers apart on the screen to zoom in, and pinch to zoom out.
 - To capture an image from the video while recording, tap **Capture**.
 - To change the focus while recording a video, tap where you want to focus. To focus on the centre of the screen, tap **[AF]**.

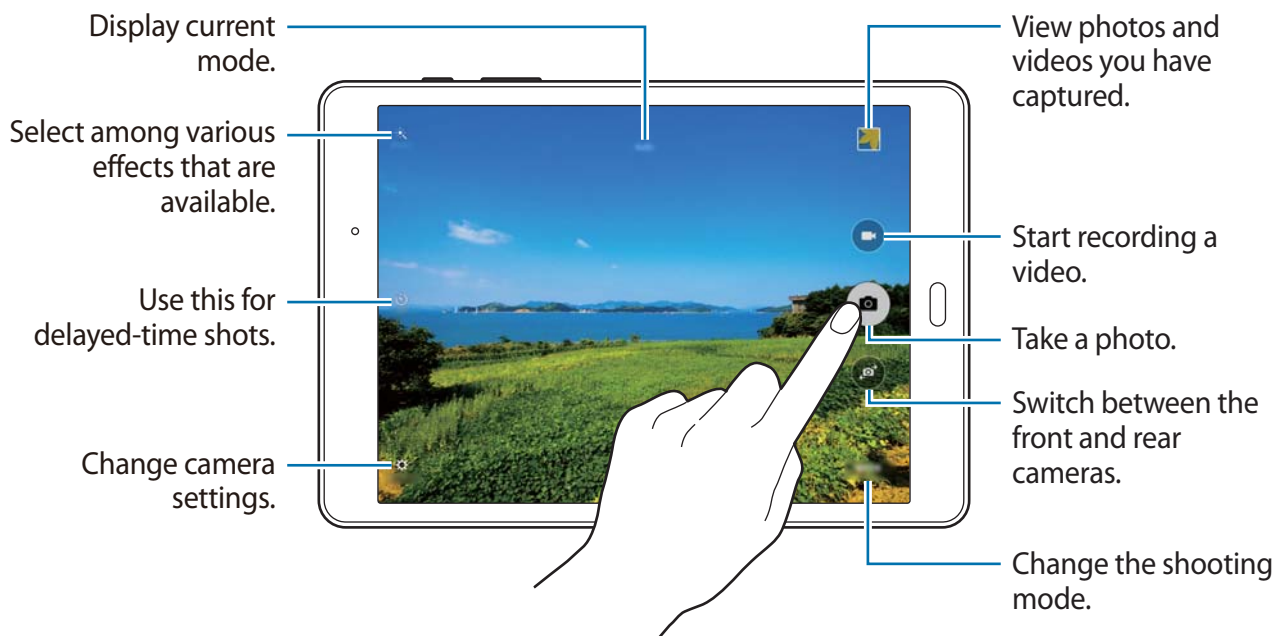

- The camera automatically shuts off when unused.
- Make sure that the lens is clean. Otherwise, the device may not work properly in some modes that require high resolutions.

Launching Camera on the locked screen

To quickly take photos of special moments, launch **Camera** on the locked screen.

On the locked screen, drag  outside the large circle.



This feature may not be available depending on the region or service provider.

Camera etiquette

- Do not take photos or record videos of other people without their permission.
- Do not take photos or record videos where legally prohibited.
- Do not take photos or record videos in places where you may violate other people's privacy.

Shooting modes

Auto

Use this mode to allow the camera to evaluate the surroundings and determine the ideal mode for the photo.

On the Apps screen, tap **Camera** → **MODE** → **Auto**.

Panorama

Use this mode to take a photo composed of many photos strung together. The device identifies the photo with  in **Gallery**.

On the Apps screen, tap **Camera** → **MODE** → **Panorama**.



To get the best shot, follow these tips:

- Move the camera slowly in one direction.
- Keep the image within the frame on the camera's viewfinder.
- Avoid taking photos of indistinct backgrounds, such as an empty sky or a plain wall.

Continuous shot

Use this mode to take a series of photos of moving subjects.

On the Apps screen, tap **Camera** → **MODE** → **Continuous shot**.

Tap and hold  to take several photos continuously.



Beauty face

Use this mode to take a photo with lightened faces for gentler images.

On the Apps screen, tap **Camera** → **MODE** → **Beauty face**.

Interval shot

Use this mode to take series of self-portraits at an interval and save photos you want.

- 1 On the Apps screen, tap **Camera**.
- 2 Tap  to use the front camera.
- 3 Tap **MODE** → **Interval shot**.
- 4 When the device detects your face, tap  to take a photo of yourself. You can also tap the screen to take a photo.
The device will take photos at the two-second intervals.
- 5 Tick photos you want to save and tap **SAVE**.

Sound & shot

Use this mode to take a photo with sound. The device identifies the photos with  in **Gallery**.

On the Apps screen, tap **Camera** → **MODE** → **Sound & shot**.

Sports

Use this mode to take a photo of fast-moving subjects.

On the Apps screen, tap **Camera** → **MODE** → **Sports**.

Camera settings

On the Apps screen, tap **Camera** → **SETTINGS**. Not all of the following options are available in both still camera and video camera modes.

- **Picture size (front) / Picture size (rear)**: Select a resolution. Higher resolutions result in higher quality photos, however they will take up more memory.
- **Video size (rear)**: Select a resolution. Higher resolutions result in higher quality videos, however they will take up more memory.
- **Gesture control**: Set the device to detect your palm, so you can use it to take self-portraits.
- **Save as horizontally flipped**: Invert the image to create a mirror-image of the original scene, when taking photos with the front camera.
- **View mode**: Change the aspect ratio of the preview screen.
- **Grid lines**: Display viewfinder guides to help composition when selecting subjects.
- **Location tags**: Set the device to attach the location tag to the photo.



- To improve GPS signals, avoid shooting in locations where the signal may be obstructed, such as between buildings or in low-lying areas, or in poor weather conditions.
- When you share a photo with the location tag attached, the location information may be exposed to others. To avoid this, when viewing the photo, tap **MORE** → **Details** → **EDIT**, and then tap ⊖ under **Location** to delete your location information.

- **Review pictures**: Set the device to show photos after capturing them.
- **Storage location**: Select the memory location for storage.
- **Volume keys function**: Set the device to use the Volume button to control the shutter or zoom function.
- **Reset settings**: Reset the camera settings.



The available options vary depending on the mode used.

Gallery

Viewing content on the device

On the Apps screen, tap **Gallery** and select an image or a video.

Video files show the  icon on the preview thumbnail.

To hide or show the menus, tap the screen.

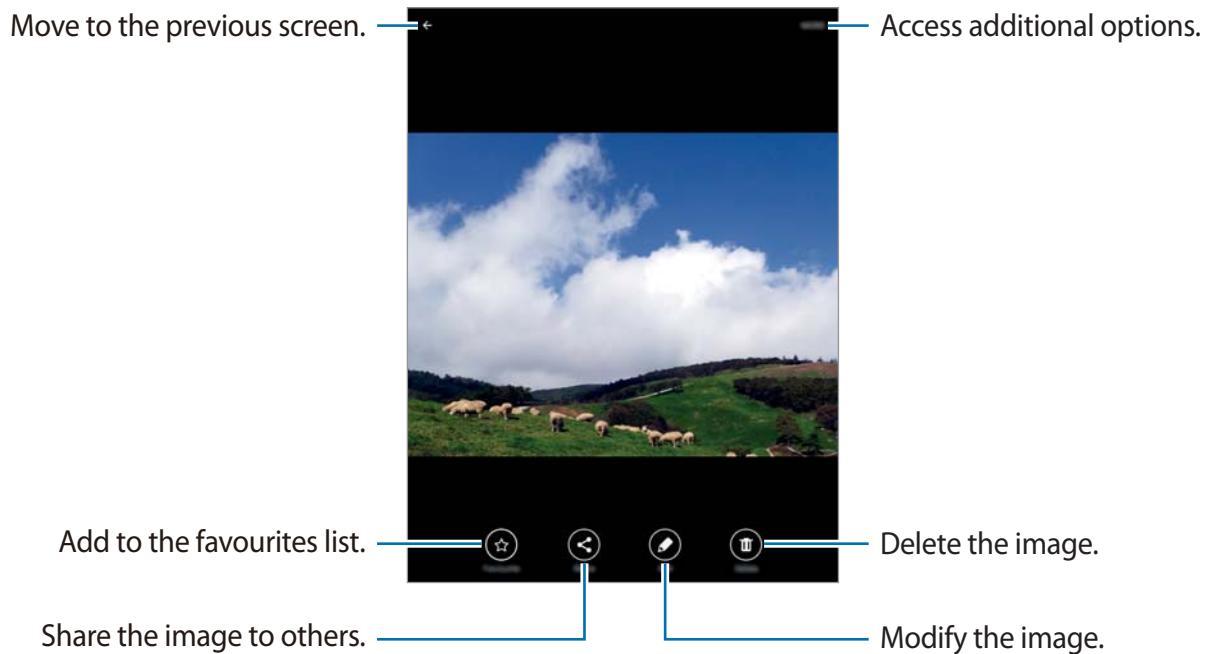

Useful apps and features

S Finder

Use this app to search for content on the device. You can apply various filters and view the search history.

Open the notifications panel and tap **S Finder**.

Searching for content



Tap the search field and enter a keyword, or tap  and say a keyword.

To get more refined results, tap filters under the search field.

To select search categories, tap **MORE** → **Select search locations**.

S Planner

Creating events

- 1 Tap **S Planner** on the Apps screen.
- 2 Tap . Alternatively, select a date with no events in it and tap the date again.
If the date already has saved events in it, tap the date and tap .

3 Enter event details.

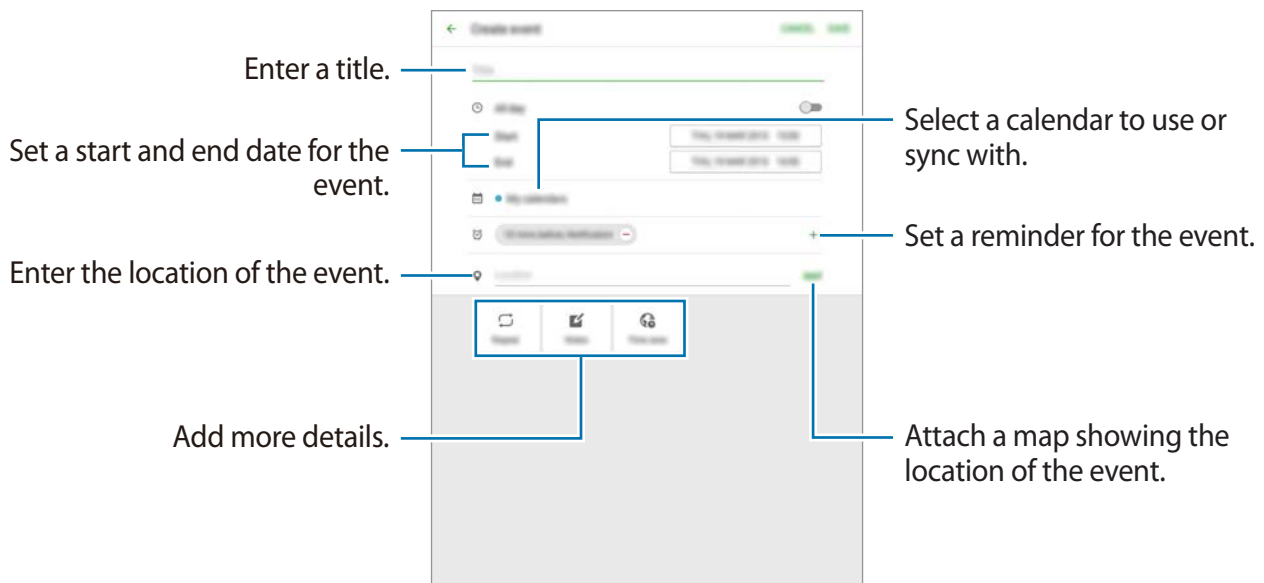

4 Tap **SAVE** to save the event.

Creating tasks

- 1 Tap **S Planner** on the Apps screen.
- 2 Tap **TASKS**, enter details, and then tap **TODAY** or **TOMORROW** to set a due date. To add more details, tap .
- 3 Tap **SAVE** to save the task.

Syncing events and tasks with your accounts

Tap **S Planner** on the Apps screen.

To add accounts to sync with, tap **MORE** → **Manage calendars** → **Add account**. Then, select an account to sync with and sign in.

To change an account's syncing option, open the Apps screen, tap **Settings** → **Accounts**, and then select an account service.

Email

Setting up email accounts

Tap **Email** on the Apps screen.

Set up an email account when opening **Email** for the first time.

Enter the email address and password. Tap **NEXT** for a private email account or tap **MANUAL SETUP** for a company email account. After that, follow the on-screen instructions to complete the setup.

To set up another email account, tap **MORE** → **Settings** → **Add account**.

If you have more than one email account, you can set one as the default account. Tap **MORE** → **Settings** → **MORE** → **Set default account**, select an account, and then tap **DONE**.

Sending emails

Tap **Email** on the Apps screen.

Tap  at the bottom of the screen to compose an email.

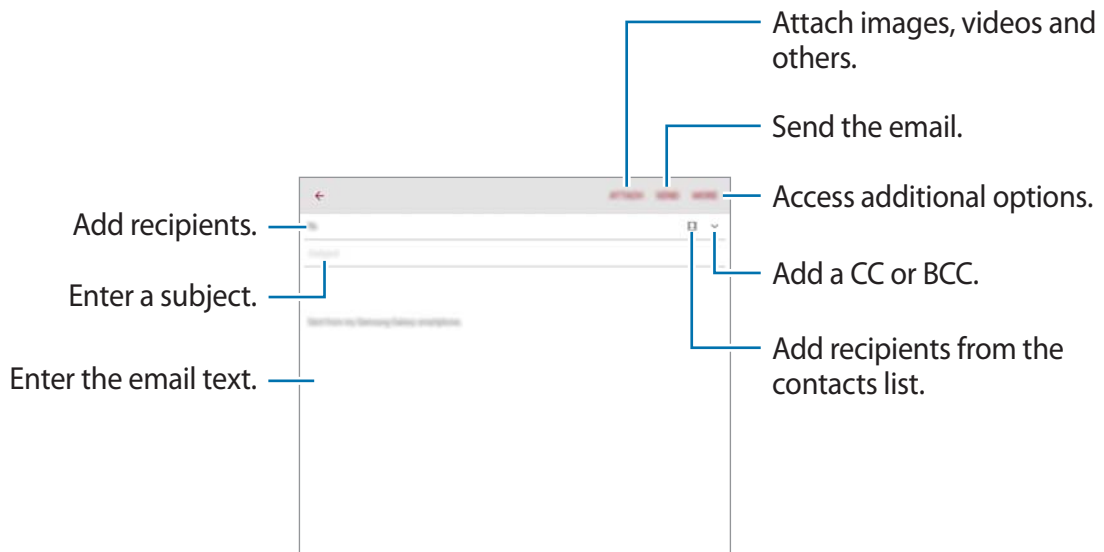

Reading emails

Tap **Email** on the Apps screen.

Select an email account to use, and new emails are retrieved.

Tap an email to read.

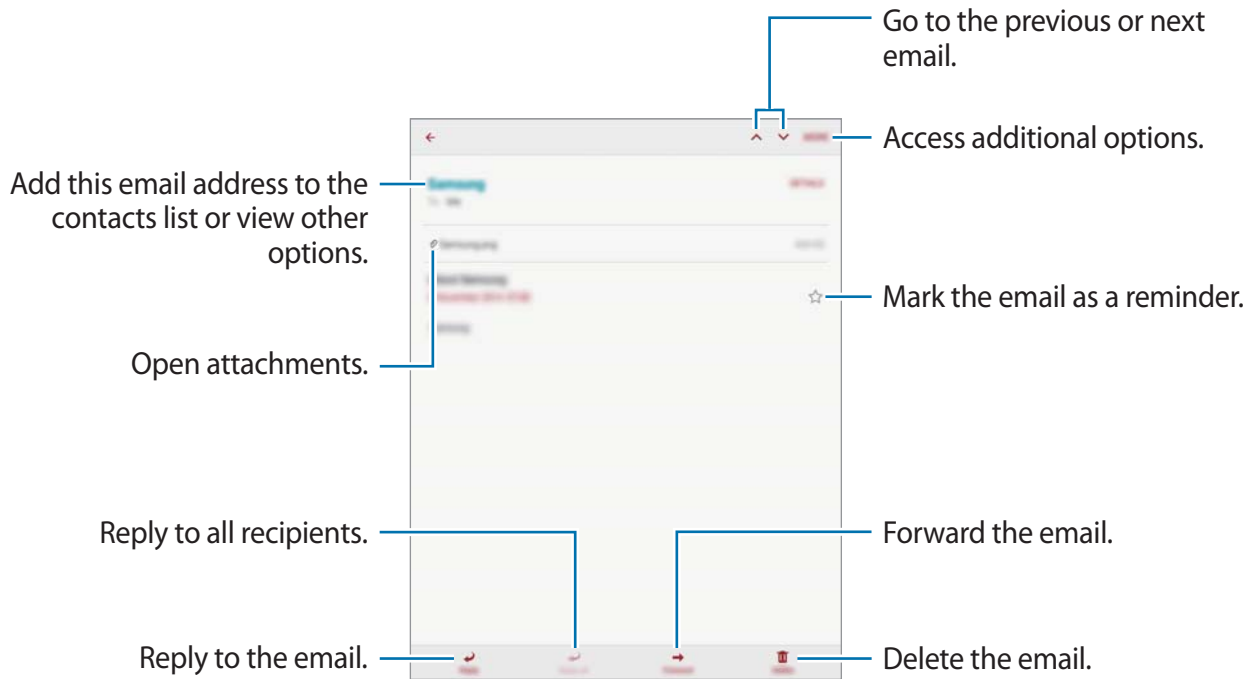

Internet

- 1 Tap **Internet** on the Apps screen.
- 2 Tap the address field.
- 3 Enter the web address or a keyword, and then tap **Go**.

To view the toolbars, drag your finger downwards slightly on the screen.

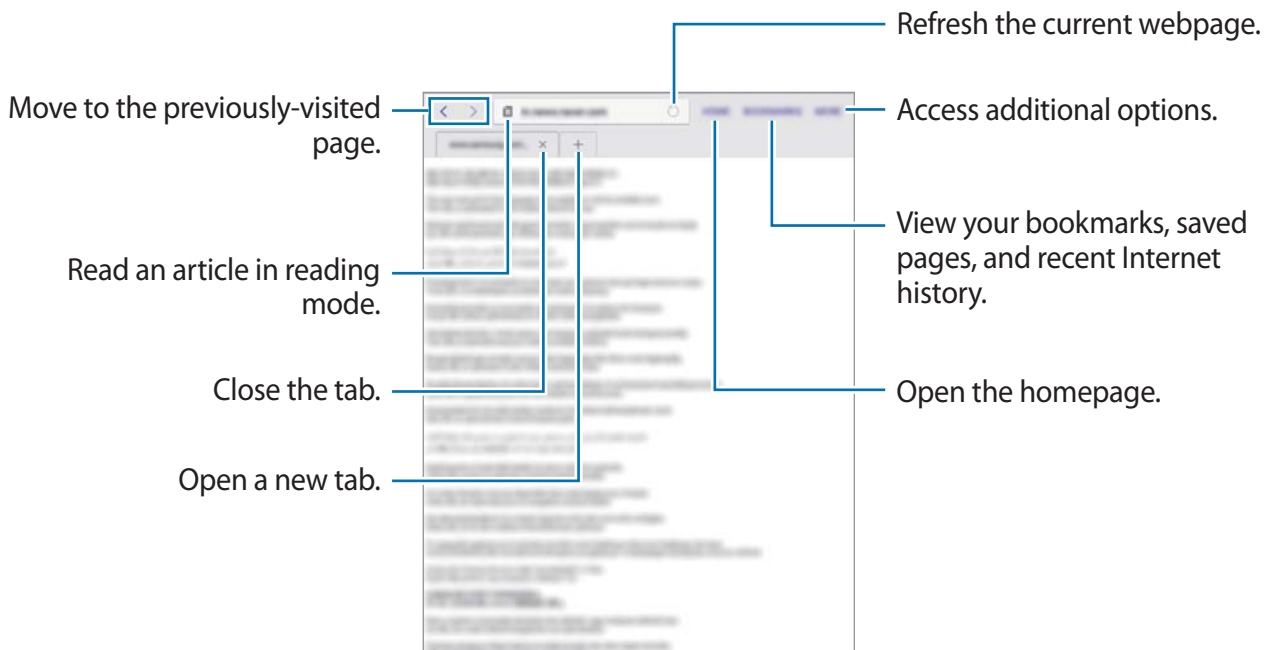

Music

Playing music

Tap **Music** on the Apps screen.

Select a music category, and then select a song to play.

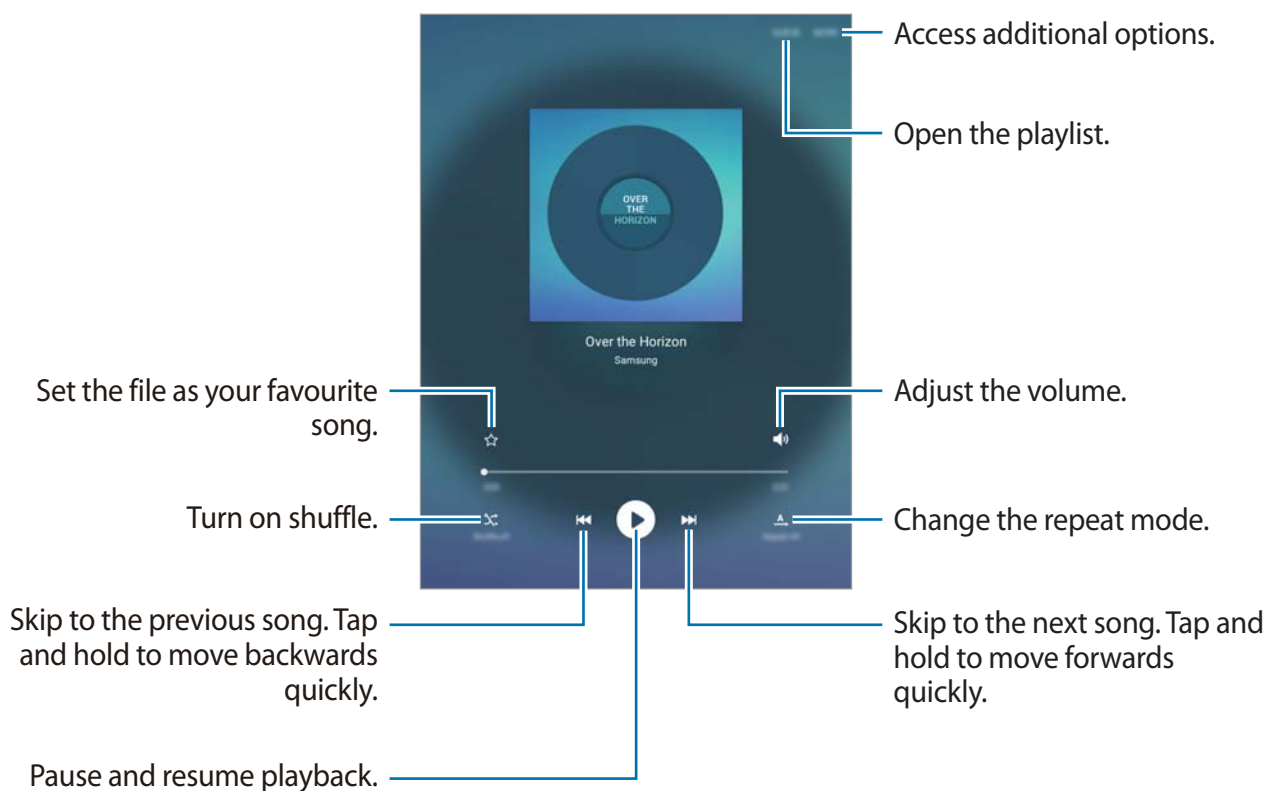

To listen to songs at equal volume levels, tap **MORE** → **Settings**, and then tap the **Smart volume** switch to activate it.

 When **Smart volume** is activated, the volume may end up louder than the device volume level. Use caution to avoid long-term exposure to loud sounds to prevent damage to your hearing.

 **Smart volume** may not be activated for some files.

Video

Playing videos

Tap **Video** on the Apps screen.

Select a video to play.

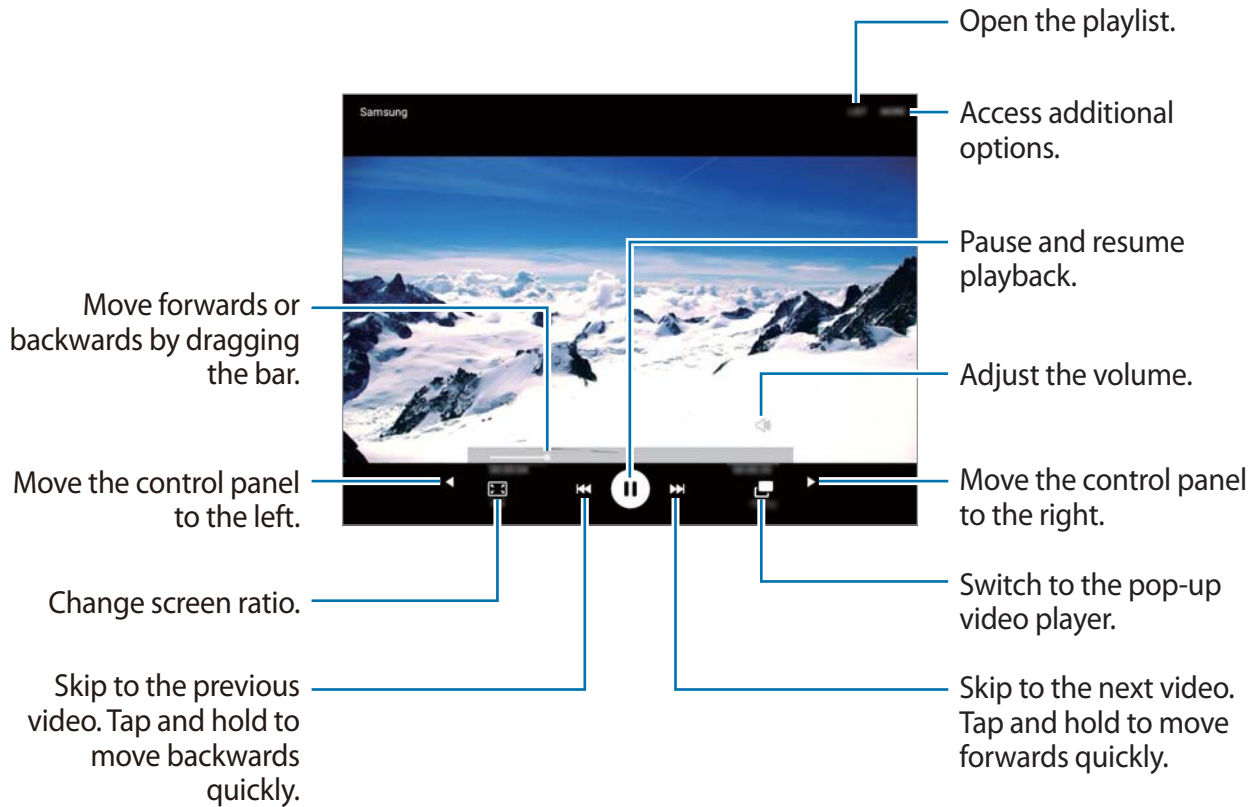

Clock

ALARM

On the Apps screen, tap **Clock** → **ALARM**.

Setting alarms

Set an alarm time and tap **OPTIONS** to set other various alarm options, and then tap **SAVE**.

To open the keypad to enter an alarm time, tap **KEYPAD**.

To activate or deactivate alarms, tap  next to the alarm in the alarms list.

Stopping alarms

Tap **DISMISS** to stop an alarm. If you have previously enabled the snooze option, tap **SNOOZE** to repeat the alarm after a specified length of time.

Deleting alarms

Tap  on an alarm in the list of alarms.

WORLD CLOCK

On the Apps screen, tap **Clock** → **WORLD CLOCK**.

Creating clocks

Enter a city name or select a city from the cities list or globe, and then tap **+**.

Deleting clocks

Tap **×** on a clock.

STOPWATCH

On the Apps screen, tap **Clock** → **STOPWATCH**.

Tap **START** to time an event. Tap **LAP** to record lap times.

Tap **STOP** to stop timing. To clear lap times, tap **RESET**.

TIMER

On the Apps screen, tap **Clock** → **TIMER**.

Set the duration, and then tap **START**.

To open the keypad to enter the duration, tap **KEYPAD**.

Tap **DISMISS** when the timer goes off.

Calculator

Use this app for simple or complex calculations.

Tap **Calculator** on the Apps screen.

To clear the history, tap **CLEAR HISTORY**.

Smart Manager

The Smart manager provides an overview of the status of your device's battery, storage, RAM, and system security. You can also automatically optimise the device with one tap of your finger.

Using the quick optimisation feature

On the Apps screen, tap **Smart Manager** → **CLEAN ALL**.

The quick optimisation feature improves device performance through the following actions.

- Identifying apps that use excessive battery power and clearing some memory.
- Deleting unnecessary files and closing apps running in the background.
- Scanning for malware and phishing attacks.

Using the Smart manager

On the Apps screen, tap **Smart Manager** and select a feature.

Battery

Check the remaining battery power and time to use the device. For devices with low battery levels, conserve battery power by activating power saving features and closing apps that are consuming an excessive amount of battery power.



The usage time left shows the time remaining before the battery power runs out. Usage time left may vary depending on your device settings and operating conditions.

Storage

Check the status of used and available memory capacity. You can delete unused and residual files or uninstall apps that you do not use any more.

RAM

Check the amount of available RAM. You can close background apps and reduce the amount of RAM you are using to speed up your device.

Device security

Check the device's security status. This feature scans your device for malware and blocks phishing attacks and malicious websites.

Google apps

Google provides entertainment, social network, and business apps. You may require a Google account to access some apps. Refer to [Setting up accounts](#) for more information.

To view more app information, access each app's help menu.



Some apps may not be available or may be labelled differently depending on the region or service provider.

Chrome

Search for information and browse webpages.

Gmail

Send or receive emails via the Google Mail service.

Google+

Share your news and follow updates that your family, friends, and others share. You can also back up your photos and videos, and more.

Maps

Find your location on the map, search for locations, and view location information for various places.

Play Music

Discover, listen to, and share music on your device.

Play Movies & TV

Watch videos stored on your device and download various content to watch from **Play Store**.

Play Books

Download various books from **Play Store** and read them.

Play Newsstand

Read news and magazines that interest you in one convenient location.

Play Games

Download games from **Play Store** and play them with others.

Drive

Store your content on the cloud, access it from anywhere, and share it with others.

YouTube

Watch or create videos and share them with others.

Photos

Manage photos, albums, and videos that you have saved on the device and uploaded to **Google+**.

Hangouts

Chat with your friends individually or in groups and use images, emoticons, and video calls while you are chatting.

Google

Search quickly for items on the Internet or your device.

Voice Search

Search quickly for items by saying a keyword or phrase.

Google Settings

Configure settings for some features provided by Google.

Connecting with other devices

Bluetooth

About Bluetooth

Bluetooth creates a direct wireless connection between two devices over short distances. Use Bluetooth to exchange data or media files with other devices.



- Samsung is not responsible for the loss, interception, or misuse of data sent or received via Bluetooth.
- Always ensure that you share and receive data with devices that are trusted and properly secured. If there are obstacles between the devices, the operating distance may be reduced.
- Some devices, especially those that are not tested or approved by the Bluetooth SIG, may be incompatible with your device.
- Do not use the Bluetooth feature for illegal purposes (for example, pirating copies of files or illegally tapping communications for commercial purposes).
Samsung is not responsible for the repercussion of illegal use of the Bluetooth feature.

Pairing with other Bluetooth devices

- 1 On the Apps screen, tap **Settings** → **Bluetooth**, and then tap the switch to activate it.
The detected devices are listed.
- 2 Select a device to pair with.
If your device has paired with the device before, tap the device name without confirming the auto-generated passkey.
If the device you want to pair with is not in the list, request that the device turns on its visibility option.
- 3 Accept the Bluetooth authorisation request on both devices to confirm.

Sending and receiving data

Many apps support data transfer via Bluetooth. You can share data, such as contacts or media files, with other Bluetooth devices. The following actions are an example of sending an image to another device.

Sending an image

- 1 On the Apps screen, tap **Gallery**.
- 2 Select an image.
- 3 Tap **Share** → **Bluetooth**, and then select a device to transfer the image to.
If the device you want to pair with is not in the list, request that the device turns on its visibility option.
- 4 Accept the Bluetooth authorisation request on the other device.

Receiving an image

When another device sends you an image, accept the Bluetooth authorisation request. You can view received images in **Gallery**.

Unpairing Bluetooth devices

- 1 On the Apps screen, tap **Settings** → **Bluetooth**.
The device displays the paired devices in the list.
- 2 Tap  next to the device's name to unpair.
- 3 Tap **Unpair**.

Wi-Fi Direct

About Wi-Fi Direct

Wi-Fi Direct connects devices directly via a Wi-Fi network without requiring an access point.

Connecting to other devices

- 1 On the Apps screen, tap **Settings** → **Wi-Fi**, and then tap the switch to activate it.
- 2 Tap **Wi-Fi Direct**.
The detected devices are listed.
If the device you want to connect to is not in the list, request that the device turns on its Wi-Fi Direct feature.
- 3 Select a device to connect to.
- 4 Accept the Wi-Fi Direct authorisation request on the other device to confirm.

Sending and receiving data

You can share data, such as contacts or media files, with other devices. The following actions are an example of sending an image to another device.

Sending an image

- 1 On the Apps screen, tap **Gallery**.
- 2 Select an image.
- 3 Tap **Share** → **Wi-Fi Direct**, and then select a device to transfer the image to.
- 4 Accept the Wi-Fi Direct authorisation request on the other device.
If the devices are already connected, the image will be sent to the other device without the connection request procedure.

Receiving an image

When another device sends you an image, accept the Wi-Fi Direct authorisation request. You can view received images in **Gallery**.

Ending the device connection

- 1 On the Apps screen, tap **Settings** → **Wi-Fi**.
- 2 Tap **Wi-Fi Direct**.
The device displays the connected devices in the list.
- 3 Tap the device name to disconnect the devices.

Quick Connect

About Quick connect

Use this feature to easily search and connect to nearby devices.



- Connection methods may vary depending on the type of connected devices or the shared content.
- Device name may vary depending on the Bluetooth devices to pair with. For example, the device name can be shown as BT MAC.

Connecting to other devices

1 Open the notifications panel and tap **Quick Connect**.

If you are using this feature for the first time, select a visibility option and tap **ENABLE QUICK CONNECT**.

When the panel opens, the Wi-Fi and Bluetooth features are activated automatically and the device searches for nearby devices.



If you have installed Samsung Link on your device, the list of devices registered with Samsung Link will appear at the top of the screen.

2 Select a device to connect to.

The next steps may vary depending on the connected device. Follow the on-screen instructions to complete the connection between the devices.

To allow nearby devices to search for your device and connect to it, tap **SETTINGS** → **Device visibility**, and then select an option.

Re-searching for devices

If the desired device does not appear in the list, search for the device.

Tap **REFRESH** and select the device from the list of detected devices.

Deactivating the Quick connect feature

Tap ↶.

Sharing content

Share content with the connected devices.

- 1 Open the notifications panel and tap **Quick Connect**.
- 2 Select a device from the list of detected devices.
- 3 Tap **Share content** and select a media category.
- 4 Select the content to share and tap **DONE**.
Your device sends the content to the connected device.

SideSync 3.0

About SideSync 3.0

Use this app to control a smartphone's screen with a virtual smartphone screen on your tablet.



You can also control your tablet's screen with a virtual screen on a computer via Wi-Fi or a USB cable. Download and install SideSync 3.0 from the Samsung website (www.samsung.com/sidesync) on the computer. For more information, refer to the help menu on the virtual screen.

- On your tablet, view messages or use the smartphone's chat room.
- On your tablet, watch a video playing on the smartphone on a larger display.
- Easily transfer files between your tablet and smartphone by dragging and dropping the files.

Before using this app

- Your tablet and smartphone must support Wi-Fi Direct.
- SideSync 3.0 must be installed on both your tablet and smartphone.
If it is not installed on any device, download and install it from **Galaxy Apps** or **Play Store**.
- SideSync 3.0 operates only on devices with Android version 4.4 or higher.

Connecting your tablet and a smartphone

- 1 On your tablet, tap **SideSync 3.0** on the Apps screen.
- 2 Launch **SideSync 3.0** on a smartphone.
- 3 The tablet searches for available smartphones automatically.
Select one of the detected smartphones.



- 4 Tap **OK** on the smartphone screen.

- 5 The smartphone's virtual screen is displayed on your tablet and the smartphone's screen is turned off.



Using the virtual smartphone screen

Browse the screen and use apps in the virtual smartphone screen. You can send or receive messages, or chat with others.



- Some features, such as **Screen Mirroring**, may not work in the virtual smartphone screen.
- The smartphone's virtual screen may differ depending on the smartphone.

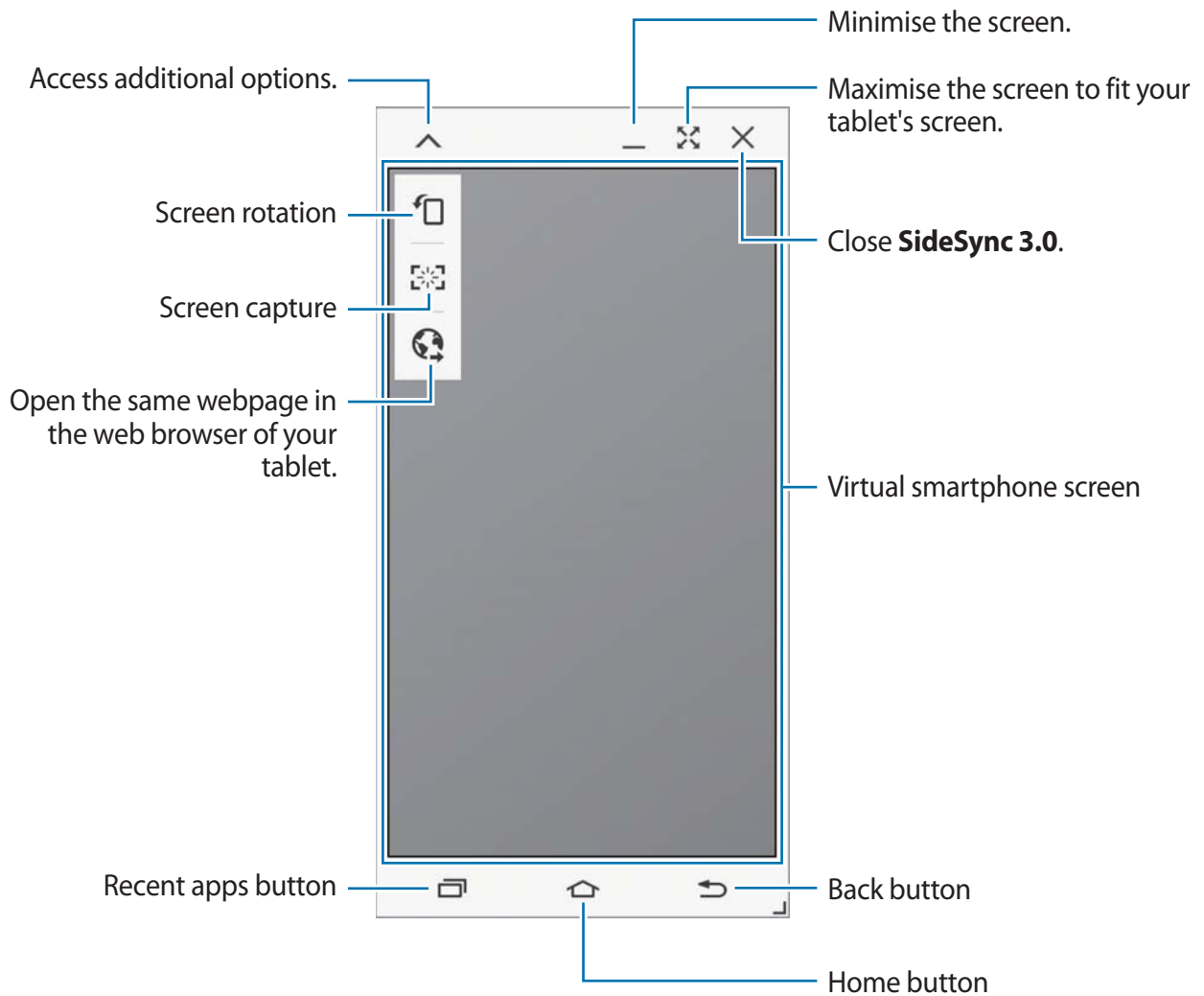

Moving the virtual smartphone screen

Tap and drag the top edge of the virtual smartphone screen to move it to another location.

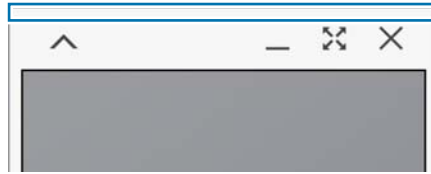

Adjusting the size of the virtual smartphone screen

- 1 Tap and hold  at the bottom right of the virtual smartphone screen.
- 2 When the frame appears, drag the frame to adjust the size.

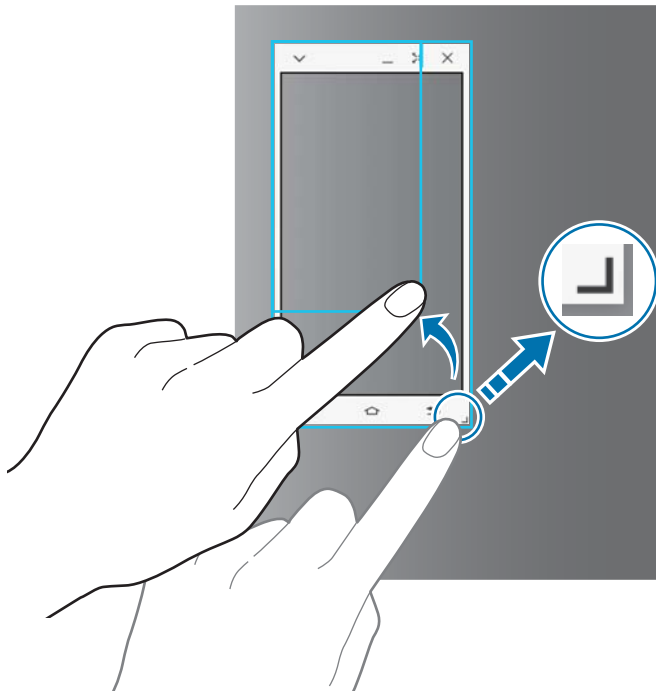

Entering text

When you enter text in the virtual smartphone screen, the tablet's keyboard appears. Enter text using the keyboard.

Switching between the smartphone screen and the virtual smartphone screen

It is not possible to use the smartphone screen and the virtual smartphone screen at the same time. When you are using the virtual smartphone screen on the tablet, the smartphone screen turns off.

Using the smartphone screen

Press the Home button on the smartphone to turn on the smartphone screen and turn off the virtual smartphone screen on the tablet.

Using the virtual smartphone screen

Tap **SWITCH TO TABLET** on the tablet's screen to turn on the virtual smartphone screen and turn off the smartphone screen.

Playing music or videos on the tablet

Play music or videos stored in the smartphone via the screen and speaker of the tablet.

- 1 Open a music or video file in the virtual smartphone screen on the tablet.
- 2 The selected file is played using the tablet's screen and speaker.

Adjust the volume on the virtual smartphone screen or the tablet during playback.

Copying files between devices

Copying files from the smartphone to the tablet

- 1 Tap and hold a file on the virtual smartphone screen.
- 2 Select the files to copy, tap and hold any selected file, and then drag it to the tablet's screen.
- 3 **My Files** is launched on the tablet's screen. Select a folder to save the file in and tap **DONE**.

Copying files from the tablet to the smartphone

- 1 Tap and hold a file on the tablet's screen.
- 2 Select the files to copy, tap and hold any selected file, and then drag it to the virtual smartphone screen.
- 3 **My Files** is launched on the virtual smartphone screen. Select a folder to save the file in and tap **DONE**.

Using call functions with the tablet

You can use your smartphone's call functions with the speaker and the microphone of the tablet. Receive an incoming call or make a call using virtual smartphone screen.



For more information about the call functions, refer to the smartphone's user manual.

Screen Mirroring

About Screen Mirroring

Use this feature to connect your device to a large screen with an AllShare Cast dongle or HomeSync and then share your contents.

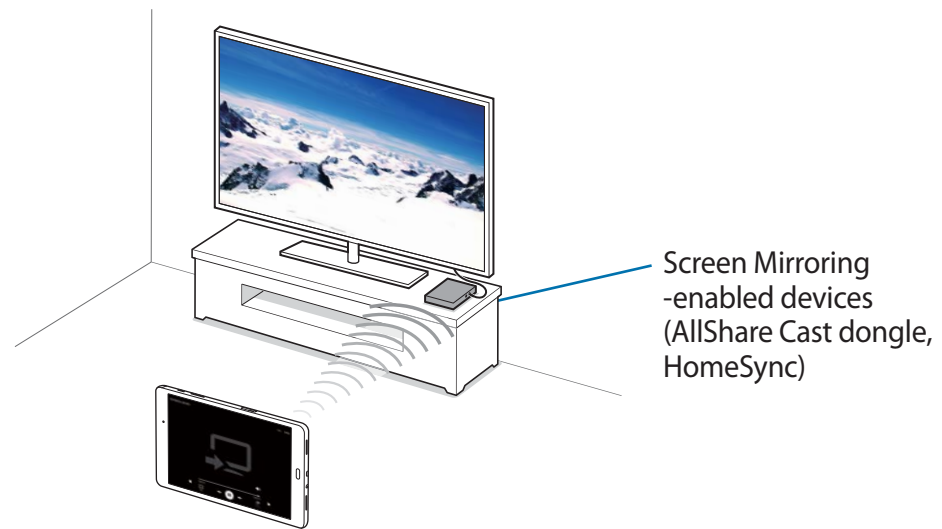

- This feature may not be available depending on the region or service provider.
- Some files may be buffered during playback, depending on the network connection.
- To save energy, deactivate this feature when not in use.
- If you specify a Wi-Fi frequency, AllShare Cast dongles or HomeSync may not be detected or connected.
- If you play videos or games on a TV, select an appropriate TV mode to get the best experience.

Viewing content on a TV

Before you connect your device to a TV, connect the screen mirroring-enabled device to the TV. To set up the connection, refer to the device's user manual. The following actions are an example of viewing content on a TV connected via an AllShare Cast dongle.

- 1 Connect the AllShare Cast dongle to the TV using an HDMI cable.
- 2 On the TV, select a connection mode, such as HDMI mode, to connect an external device.
- 3 Open the notifications panel and tap **EDIT** → **Screen Mirroring**.
The detected devices are listed.
- 4 Select a device to connect to.
Your device's screen appears on the TV screen.
If you connect the device for the first time, tap and hold the dongle's name in the list and enter the PIN shown on the TV screen.
- 5 Open or play a file, and then control the display with the keys on your device.

Mobile printing

Connect the device to a printer via Wi-Fi or Wi-Fi Direct, and print images or documents.



Some printers may not be compatible with the device.

Adding printer plug-ins

Add printer plug-ins for printers you want to connect the device to.

On the Apps screen, tap **Settings** → **More connection settings** → **Printing** → **Download plug-in**, and search for a printer plug-in in **Play Store**. Select a printer plug-in and install it.

Connecting to a printer

On the Apps screen, tap **Settings** → **More connection settings** → **Printing**, select a printer plug-in, and then tap the switch to activate it. The device searches for printers that are connected to the same Wi-Fi network as your device.

To add printers manually, select a printer plug-in, tap **MORE** → **Add printer** → **ADD PRINTER**, enter details, and then tap **OK**.

To change print settings, select a printer plug-in and tap **MORE** → **Printing settings**.

Printing content

While viewing content, such as images or documents, tap **Share** → **Print** → ▼ → **All printers**, and then select a printer.

Device & data manager

Transferring data from your previous device

You can transfer data from a previous device to your new device via Samsung Smart Switch. The following versions of Samsung Smart Switch are available.

- Mobile version (Smart Switch Mobile): Transfer data between mobile devices. You can download the app from **Galaxy Apps** or **Play Store**.
- Computer version: Transfer data between your device and a computer. You can download the app from www.samsung.com/smartswitch.



- Samsung Smart Switch is not supported on some devices or computers.
- Limitations apply. Visit www.samsung.com/smartswitch for details. Samsung takes copyright seriously. Only transfer content that you own or have the right to transfer.

Transferring data from a mobile device

Transfer data from your previous device to your new device.

The following actions are an example of transferring data from your previous Android device. To import data from a mobile device with a different operating system, refer to the on-screen instructions.

- 1 Download and install Smart Switch from **Galaxy Apps** or **Play Store** on your previous and new devices.
- 2 Launch **Smart Switch Mobile** on both devices.
- 3 On your previous device, tap **Android Device** → **START**.
- 4 On your previous device, tap **Sending device** → **CONNECT**.
The devices will automatically connect.

- 5 On your previous device, select data to send to your new device and tap **SEND**.
- 6 On your new device, tap **RECEIVE** on the connection request pop-up window to receive the data.
The data transfer will begin.
- 7 On both devices, tap **FINISH** when the data transfer is complete.

Transferring data from a computer

Back up data from your previous device to a computer and import the data to your new device.

- 1 On the computer, visit www.samsung.com/smartswitch to download Smart Switch.
 - 2 On the computer, launch Smart Switch.
-  If your previous device is not a Samsung device, back up data to a computer using a program provided by the device's manufacturer. Then, skip to the fifth step.
- 3 Connect your previous device to the computer using the USB cable.
 - 4 On the computer, follow the on-screen instructions to back up data from the device. Then, disconnect your previous device from the computer.
 - 5 Connect your new device to the computer using the USB cable.
 - 6 On the computer, follow the on-screen instructions to transfer data to your new device.

Using the device as a removable disk for data transfer

Move audio, video, image, or other types of files from the device to the computer, or vice versa.



Do not disconnect the USB cable from the device when you are transferring files. Doing so may cause data loss or device damage.



The devices may not connect properly if they are connected via a USB hub. Directly connect the device to the computer's USB port.

- 1 Connect the device to the computer using the USB cable.
- 2 Open the notifications panel, and then tap **Connected as a media device** → **Media device (MTP)**.

Tap **Camera (PTP)** if your computer does not support Media Transfer Protocol (MTP) or not have any appropriate driver installed.

- 3 Transfer files between your device and the computer.

Updating the device

The device can be updated to the latest software.

Updating over the air

The device can be directly updated to the latest software by the firmware over-the-air (FOTA) service.

On the Apps screen, tap **Settings** → **About device** → **Software update** → **Update now**.



To automatically check for available updates, tap the **Auto update** switch to activate it.

Updating with Smart Switch

Connect the device to a computer and update the device to the latest software.

- 1 On the computer, visit www.samsung.com/smartswitch to download and install Smart Switch.
- 2 On the computer, launch Smart Switch.
- 3 Connect the device to the computer using a USB cable.
- 4 On the computer, click the update button in the connection window.



- Do not turn off the computer or disconnect the USB cable while the device is updating.
- While updating the device, do not connect other media devices to the computer. Doing so may interfere with the update process. Before updating, disconnect all other media devices from the computer.

Backing up and restoring data

Keep your personal information, app data, and settings safe on your device. You can back up your sensitive information to a backup account and access it later. You must sign in to your Google or Samsung account to back up or restore data. Refer to [Setting up accounts](#) for more information.

Using a Samsung account

On the Apps screen, tap **Settings** → **Backup and reset** → **Back up my data**, select the items to back up, and then tap **BACK UP NOW**.

To set the device to automatically back up data, tap the **Auto back up** switch to activate it.

To restore data using a Samsung account, tap **Restore**. Current data will be deleted from the device to restore the selected items.

Using a Google account

On the Apps screen, tap **Settings** → **Backup and reset**, and then tap the **Back up my data** switch to activate it. Tap **Backup account** and select an account as the backup account.

To restore data using a Google account, tap the **Automatic restore** switch to activate it. When you reinstall apps, backed up settings and data will be restored.

Performing a data reset

Delete all settings and data on the device. Before performing a factory data reset, ensure you back up all important data stored on the device. Refer to [Backing up and restoring data](#) for more information.

On the Apps screen, tap **Settings** → **Backup and reset** → **Factory data reset** → **RESET DEVICE** → **ERASE EVERYTHING**. The device automatically restarts.

Settings

About Settings

Use this app to configure the device, set app options, and add accounts.

Tap **Settings** on the Apps screen.

To search for settings by entering keywords, tap **SEARCH**.

Connections

Wi-Fi

Activate the Wi-Fi feature to connect to a Wi-Fi network and access the Internet or other network devices.

On the Settings screen, tap **Wi-Fi**, and then tap the switch to activate it.

To use options, tap **MORE**.

Setting Wi-Fi sleep policy

Tap **MORE** → **Keep Wi-Fi on during sleep**.

Bluetooth

Activate the Bluetooth feature to exchange information over short distances.

On the Settings screen, tap **Bluetooth**, and then tap the switch to activate it.

Flight mode

This disables all wireless functions on your device. You can use only non-network services.

On the Settings screen, tap **Flight mode**, and then tap the switch to activate it.

Data usage

Keep track of your data usage amount.

On the Settings screen, tap **Data usage**.

To use more options, tap **MORE**.

- **Restrict networks:** Set the device to disable sync in the background while using Wi-Fi network.

More connection settings

Customise settings to control networks.

On the Settings screen, tap **More connection settings**.

Printing

Configure settings for printer plug-ins installed on the device. You can search for available printers or add one manually to print files.

VPN

Set up and connect to virtual private networks (VPNs).

Ethernet

The Ethernet option is available when an Ethernet adaptor is connected to the device. Use this option to activate the Ethernet feature and configure network settings.

Device

Sounds and notifications

Change settings for various sounds on the device.

On the Settings screen, tap **Sounds and notifications**.

- **Sound mode:** Set the device to use sound mode or silent mode.
- **Volume:** Adjust the volume level for music and videos, system sounds, and notifications.
- **Ringtones and sounds:** Change the ringtone and system sound settings.
- **Sound quality and effects:** Select a sound effect to apply when you adjust to music.
- **Do not disturb:** Change settings for managing interruptions.
- **Notifications on lock screen:** Set whether or not to show the content of notifications on the locked screen.
- **App notifications:** Change the notification settings for each app.

Display

Change the display settings.

On the Settings screen, tap **Display**.

- **Brightness:** Set the brightness of the display.
- **Font:** Change the font size and type.
- **Screen timeout:** Set the length of time the device waits before turning off the display's backlight.
- **Smart stay:** Set the device to prevent the display backlight from turning off while you are looking at the display.
- **Screen mode:** Change the screen mode.
- **Daydream:** Set the device to launch a screensaver when the device is charging or connected to a desktop dock.

S Pen

Change the settings for using the S Pen.

On the Settings screen, tap **S Pen**.

- **Air command:** Set the device to display the air command features when you hover the S Pen over the screen and press the S Pen button.
- **Air view:** Activate the air view feature to perform various actions with the S Pen.
- **Pointer:** Set the device to display the S Pen pointer when hovering the S Pen over the screen.
- **Direct pen input:** Set the device to display the handwriting field icon when hovering the S Pen over a text input field.
- **Disable pen detection:** Set the screen not to respond to the other S Pens when the S pen is inserted.
- **S Pen sound:** Set the device to make writing sounds when you write or draw on the screen with the S Pen.
- **Detachment options:** Set the device to automatically launch Action memo or display the air command features when the S Pen is removed from the slot.

Motions and gestures

Activate the motion recognition feature and change the settings that control motion recognition on your device.

On the Settings screen, tap **Motions and gestures**.

- **Mute:** Set the device to mute alarms by using palm motions.
- **Palm swipe to capture:** Set the device to capture a screenshot when you sweep your hand to the left or right across the screen.

Applications

Manage the device's apps and change their settings.

On the Settings screen, tap **Applications**.

Application manager

View and manage the apps on your device.

Default applications

Select a default setting for using apps.

Application settings

Customise the settings for each app.

Users

Set up and manage user profiles for personalised settings. Refer to [Multiple users](#) for more information.

On the Settings screen, tap **Users**.

Personal

Wallpaper

Change the wallpaper settings for the Home screen and the locked screen.

On the Settings screen, tap **Wallpaper**.

Lock screen and security

Change the settings for securing the device.

On the Settings screen, tap **Lock screen and security**.



The available options may vary depending on the screen lock method selected.

- **Screen lock type:** Change the screen lock method.
- **Show information:** Change settings for the items displayed on the locked screen.
- **Swipe lock settings:** Change settings for the swipe screen lock method.
- **Device security:** Scan for and remove malware from the device. You can also activate the real-time scanning feature to block phishing attacks and malicious websites.
- **Find My Mobile:** Access the Find my mobile website (findmymobile.samsung.com). You can track and control your lost or stolen device from the Find my mobile website.
- **Unknown sources:** Set the device to allow the installation of apps from unknown sources.
- **Other security settings:** Configure additional security settings.

Privacy

Change the settings for maintaining your privacy.

On the Settings screen, tap **Privacy**.

- **Location:** Change settings for location information permissions.
- **Private mode:** Set the device to prevent others from accessing your personal content by activating private mode.
- **Report diagnostic info:** Set the device to automatically send the device's diagnostic and usage information to Samsung.

Accessibility

Use this feature to improve accessibility to the device.

On the Settings screen, tap **Accessibility**.

- **Vision:** Customise the settings to improve accessibility for visually impaired users.
 - **Galaxy TalkBack:** Activate TalkBack, which provides voice feedback.
 - **Galaxy TalkBack help:** View help information to learn how to use Galaxy TalkBack.
 - **Dark screen:** Set the device to turn the screen off at all times to keep the content on your screen private.
 - **Rapid key input:** Set the device to enter a character when you release your finger from the character on the keyboard. You can use this feature to enter characters instead of releasing your finger and double-tapping on the screen.
 - **Speak passwords:** Set the device to read the password aloud when you enter the password while TalkBack is activated.
 - **Font size:** Change the font size.
 - **Magnification gestures:** Set the device to magnify the screen and to zoom in on a specific area.
 - **Magnifier window:** Activate a magnifier to zoom in on the screen to view a larger version of the content.
 - **Greyscale:** Display colours on the screen as grey tones.
 - **Negative colours:** Reverse the display colours to improve visibility.
 - **Colour adjustment:** Adjust the colour scheme for the screen when the device determines that you are colour blind or having difficulty reading content.
 - **Accessibility shortcut:** Set the device to activate TalkBack when you press and hold the Power button, and then tap and hold the screen with two fingers.
 - **Text-to-speech options:** Change the settings for text-to-speech features used when TalkBack is activated, such as languages, speed, and more.

- **Hearing:** Customise the settings to improve accessibility for users with hearing impairment.
 - **Turn off all sounds:** Set the device to mute all device sounds, such as media sounds.
 - **Samsung subtitles (CC):** Set the device to display closed captions on content supported by Samsung and to change the closed caption settings.
 - **Google subtitles (CC):** Set the device to display closed captions on content supported by Google and to change the closed caption settings.
 - **Left/right sound balance:** Set the device to adjust the sound balance when using a headset.
 - **Mono audio:** Set the device to switch the sound output from stereo to mono when a headset is connected.
- **Dexterity and interaction:** Customise the settings to improve accessibility for users who have reduced dexterity.
 - **Universal switch:** Set the device to scan and highlight items on the screen, and then read them aloud. You can control the touch screen by connecting an external switch, tapping the screen, or by using head movements and face gestures.
 - **Assistant menu:** Set the device to show the assistive shortcut icon that helps you access functions supported by external buttons or features on the notifications panel. You can also edit the menu on the shortcut icon.
 - **Tap and hold delay:** Set the recognition time for tapping and holding the screen.
 - **Interaction control:** Activate interaction control mode to restrict the device's reaction to inputs while using apps.
- **Direction lock:** Create a directional combination to unlock the screen.
- **Direct access:** Set the device to open selected accessibility menus when you press the Home button three times quickly.
- **Notification reminder:** Set the device to alert you to notifications that you have not checked at the interval.
- **Single tap mode:** Set the device to control notifications by tapping the button instead of dragging it.
- **Manage accessibility:** Export or import the accessibility settings to share them with other devices.
- **Services:** View accessibility services installed on the device.

Accounts

Add email or SNS accounts.

On the Settings screen, tap **Accounts**.

Backup and reset

Change the settings for managing settings and data.

On the Settings screen, tap **Backup and reset**.

- **Back up my data:** Back up your personal information and app data to the Samsung server. You can also set the device to automatically back up data.
- **Restore:** Restore previously backed up personal information and app data from your Samsung account.
- **Backup account:** Set up or edit your Google backup account.
- **Back up my data:** Set the device to back up settings and app data to the Google server.
- **Automatic restore:** Set the device to restore settings and app data when the apps are reinstalled on the device.
- **Factory data reset:** Reset settings to the factory default values and delete all data.

System

Language and input

Change the settings for text input. Some options may not be available depending on the selected language.

On the Settings screen, tap **Language and input**.

- **Language:** Select a display language for all menus and apps.
- **Default keyboard:** Select a default keyboard type for text input.
- **Samsung keyboard:** Change the Samsung keyboard settings.



The available options may vary depending on the region or service provider.

- **Google voice typing:** Change the voice input settings.
- **Voice input:** Change the settings for the voice recogniser.
- **Text-to-speech options:** Change the text-to-speech settings.
- **Pointer speed:** Adjust the pointer speed for the mouse or trackpad connected to your device.

Battery

View battery power information and change power saving options.

On the Settings screen, tap **Battery**.

- **Power saving mode:** Activate power-saving mode and change the settings for power-saving mode.
- **Ultra power saving mode:** Extend standby time and reduce battery consumption by displaying a simpler layout and allowing limited access to an app.
- **Display battery percentage:** Set the device to display the remaining battery life.



The usage time left shows the time remaining before the battery power runs out. Usage time left may vary depending on your device settings and operating conditions.

Storage

View memory information for your device and memory card, or format a memory card.

On the Settings screen, tap **Storage**.



Formatting a memory card permanently deletes all data from it.



The actual available capacity of the internal memory is less than the specified capacity because the operating system and default apps occupy part of the memory. The available capacity may change when you upgrade the device.

Accessories

Change the accessory settings.

On the Settings screen, tap **Accessories**.

- **Automatic unlock:** Set the device to unlock automatically when the cover is flipped open. You can use this feature only for some screen lock methods.

Date and time

Access and alter the following settings to control how the device displays the time and date.

On the Settings screen, tap **Date and time**.



If the battery remains fully discharged or removed from the device, the time and date is reset.

- **Automatic date and time:** Automatically update the time and date when moving across time zones.
- **Set date:** Set the current date manually.
- **Set time:** Set the current time manually.
- **Select time zone:** Set the home time zone.
- **Use 24-hour format:** Display time in 24-hour format.
- **Select date format:** Select a date format.

About device

Access device information, edit the device name, or update device software.

On the Settings screen, tap **About device**.

Appendix

Troubleshooting

Before contacting a Samsung Service Centre, please attempt the following solutions. Some situations may not apply to your device.

When you turn on your device or while you are using the device, it prompts you to enter one of the following codes:

- **Password:** When the device lock feature is enabled, you must enter the password you set for the device.
- **PIN:** When using the device for the first time or when the PIN requirement is enabled, you must enter the PIN supplied with the SIM or USIM card. You can disable this feature by using the Lock SIM card menu.
- **PUK:** Your SIM or USIM card is blocked, usually as a result of entering your PIN incorrectly several times. You must enter the PUK supplied by your service provider.
- **PIN2:** When you access a menu requiring the PIN2, you must enter the PIN2 supplied with the SIM or USIM card. For more information, contact your service provider.

Your device displays network or service error messages

- When you are in areas with weak signals or poor reception, you may lose reception. Move to another area and try again. While moving, error messages may appear repeatedly.
- You cannot access some options without a subscription. For more information, contact your service provider.

Your device does not turn on

When the battery is completely discharged, your device will not turn on. Fully charge the battery before turning on the device.

The touch screen responds slowly or improperly

- If you attach a protective cover or optional accessories to the touch screen, the touch screen may not function properly.
- If you are wearing gloves, if your hands are not clean while touching the touch screen, or if you tap the screen with sharp objects or your fingertips, the touch screen may malfunction.
- The touch screen may malfunction in humid conditions or when exposed to water.
- Restart your device to clear any temporary software bugs.
- Ensure that your device software is upgraded to the latest version.
- If the touch screen is scratched or damaged, visit a Samsung Service Centre.

Your device freezes or has fatal errors

If your device freezes or hangs, you may need to close apps or turn off the device and turn it on again. If your device is frozen and unresponsive, press and hold the Power button and the Volume button down simultaneously for more than 7 seconds to restart it.

If this does not solve the problem, perform a factory data reset. On the Apps screen, tap **Settings** → **Backup and reset** → **Factory data reset** → **RESET DEVICE** → **ERASE EVERYTHING**. Before performing the factory data reset, remember to make backup copies of all important data stored in the device.

If the problem is still not resolved, contact a Samsung Service Centre.

The Internet is often disconnected

- Ensure that you are not blocking the device's internal antenna.
- When you are in areas with weak signals or poor reception, you may lose reception. You may have connectivity problems due to issues with the service provider's base station. Move to another area and try again.
- When using the device while moving, wireless network services may be disabled due to issues with the service provider's network.

The battery icon is empty

Your battery is low. Charge the battery.

The battery does not charge properly (For Samsung-approved chargers)

- Ensure that the charger is connected properly.
- Visit a Samsung Service Centre and have the battery replaced.

The battery depletes faster than when first purchased

- When you expose the device or the battery to very cold or very hot temperatures, the useful charge may be reduced.
- Battery consumption increases when you use messaging features or some apps, such as games or the Internet.
- The battery is consumable and the useful charge will get shorter over time.

Your device is hot to the touch

When you use apps that require more power or use apps on your device for an extended period of time, your device may feel hot to the touch. This is normal and should not affect your device's lifespan or performance.

Error messages appear when launching the camera

Your device must have sufficient available memory and battery power to operate the camera app. If you receive error messages when launching the camera, try the following:

- Charge the battery.
- Free some memory by transferring files to a computer or deleting files from your device.
- Restart the device. If you are still having trouble with the camera app after trying these tips, contact a Samsung Service Centre.

Photo quality is poorer than the preview

- The quality of your photos may vary, depending on the surroundings and the photography techniques you use.
- If you take photos in dark areas, at night, or indoors, image noise may occur or images may be out of focus.

Error messages appear when opening multimedia files

If you receive error messages or multimedia files do not play when you open them on your device, try the following:

- Free some memory by transferring files to a computer or deleting files from your device.
- Ensure that the music file is not Digital Rights Management (DRM)-protected. If the file is DRM-protected, ensure that you have the appropriate licence or key to play the file.
- Ensure that the file formats are supported by the device. If a file format is not supported, such as DivX or AC3, install an app that supports it. To confirm the file formats that your device supports, visit www.samsung.com.
- Your device supports photos and videos captured with the device. Photos and videos captured by other devices may not work properly.
- Your device supports multimedia files that are authorised by your network service provider or providers of additional services. Some content circulated on the Internet, such as ringtones, videos, or wallpapers, may not work properly.

Another Bluetooth device is not located

- Ensure that the Bluetooth wireless feature is activated on your device.
- Ensure that the Bluetooth wireless feature is activated on the device you wish to connect to.
- Ensure that your device and the other Bluetooth device are within the maximum Bluetooth range (10 m).

If the tips above do not solve the problem, contact a Samsung Service Centre.

A connection is not established when you connect the device to a computer

- Ensure that the USB cable you are using is compatible with your device.
- Ensure that you have the proper driver installed and updated on your computer.
- If you are a Windows XP user, ensure that you have Windows XP Service Pack 3 or higher installed on your computer.

Your device cannot find your current location

GPS signals may be obstructed in some locations, such as indoors. Set the device to use Wi-Fi or a mobile network to find your current location in these situations.

Data stored in the device has been lost

Always make backup copies of all important data stored in the device. Otherwise, you cannot restore data if it is corrupted or lost. Samsung is not responsible for the loss of data stored in the device.

A small gap appears around the outside of the device case

- This gap is a necessary manufacturing feature and some minor rocking or vibration of parts may occur.
- Over time, friction between parts may cause this gap to expand slightly.

Removing the battery (non-removable type)



- These instructions are only for your service provider or an authorised repair agent.
- Damage or faults caused by the unauthorised removal of the battery are not covered by the warranty.
- To remove or replace the battery, contact your service provider or an authorised repair agent.

- 1 Insert the device opening tool into the gap between the device's screen and the back cover.

Then, start separating the screen from the back cover by using the tool to pry them apart as shown in the image below.

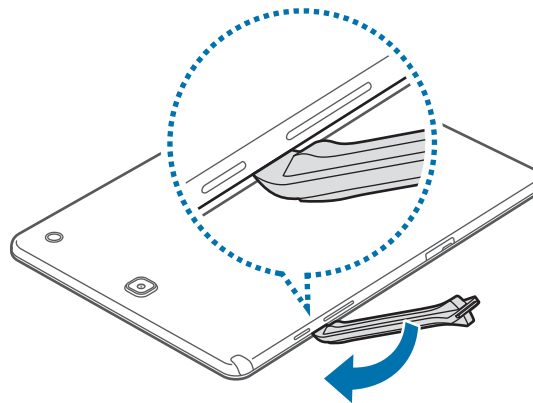

Take care when inserting the tool to avoid damaging the device's internal components.

- 2 Continue reinserting the tool and prying the screen and the back cover apart at close intervals around the device.



Rotate the back cover carefully and ensure that the hooks are not damaged.

- 3 When the screen is disengaged, separate the screen and the back cover.
Then, put the back cover aside and place the screen face down on a flat work surface.

4 Loosen and remove the screws as shown in the image below.

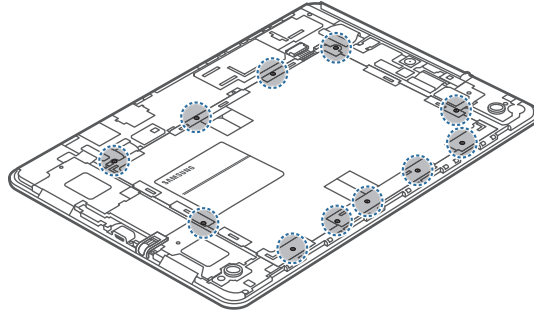

5 Disconnect the battery connector as shown in the image below.

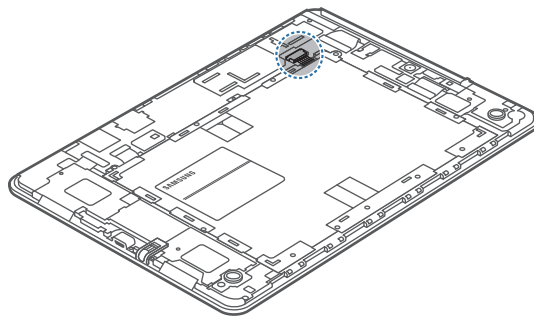

6 Remove the battery.

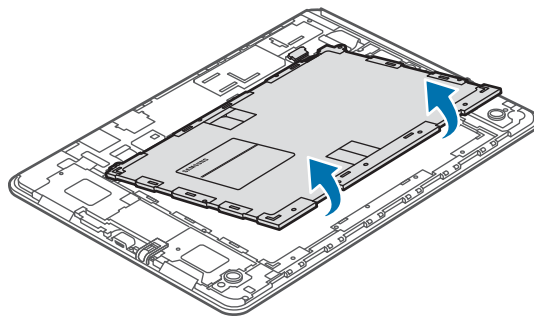

Copyright

Copyright © 2015 Samsung Electronics

This manual is protected under international copyright laws.

No part of this manual may be reproduced, distributed, translated, or transmitted in any form or by any means, electronic or mechanical, including photocopying, recording, or storing in any information storage and retrieval system, without the prior written permission of Samsung Electronics.

Trademarks

- SAMSUNG and the SAMSUNG logo are registered trademarks of Samsung Electronics.
- Bluetooth® is a registered trademark of Bluetooth SIG, Inc. worldwide.
- Wi-Fi®, Wi-Fi Protected Setup™, Wi-Fi Direct™, Wi-Fi CERTIFIED™, and the Wi-Fi logo are registered trademarks of the Wi-Fi Alliance.
- All other trademarks and copyrights are the property of their respective owners.