

acer
explore beyond limits™

Liquid Z330



User's Manual

© 2015 All Rights Reserved

Acer Liquid Z330 Duo User's Manual

Model: T01

This revision: August 2015

Sign up for an Acer ID and enjoy great benefits

Open the *Acer Portal* app from the *Home* screen to sign up for an Acer ID or sign in if you already have an Acer ID.

There are three great benefits for you to get an Acer ID:

- Build Your Own Cloud with Acer BYOC.
- Get the latest offers and product information.
- Register your device for warranty service.

For more information, please visit the AcerCloud website:

www.acer.com/byoc-start



Important

This manual contains proprietary information that is protected by copyright laws. The information contained in this manual is subject to change without notice. Images provided herein are for reference only and may contain information or features that do not apply to your device. Acer Group shall not be liable for technical or editorial errors or omissions contained in this manual.

Acer Liquid Z330 Duo Smartphone

Model number: _____

Serial number: _____

Date of purchase: _____

Place of purchase: _____

TABLE OF CONTENTS

Setting up	5	Messaging	31
Unpacking your smartphone.....	5	Creating a new message	31
Getting to know your smartphone.....	5	Replying to a message	32
Views	5	Multimedia messages	33
Charging the battery	6	Receiving multimedia messages	33
Installing a SIM or microSD card	7	Going online	35
SIM card lock	10	Browsing the internet	35
Using your smartphone	11	Using the browser	35
Turning on for the first time.....	11	Setting up Email	36
Sign in to or create a Google account ...	11	Google services	36
Entering your PIN.....	11	Setting up your Google email	36
Activating a new SIM card	11	Voice search	37
Locking your smartphone	12	Play Store	38
Waking your smartphone	12	Google Hangouts.....	40
Navigating through menus and options.	12	Maps, Navigation, Places and Latitude	40
Using the touchscreen.....	13	Using the Camera	41
Onscreen keyboards	14	Camera/camcorder icons and indicators ..	41
Google keyboard.....	14	Mode Selector.....	43
Predictive text	15	Settings menus	45
The Home screen	15	Taking a photo	46
Search.....	16	Shooting a video	46
The extended Home screen.....	16	Supported formats	46
Personalizing the Home screen	16	Viewing photos and videos	46
The Application (Apps) menu.....	19	Geotagging	47
Notification and status area	20	Advanced settings	48
Multitasking	21	Putting your smartphone in Airplane	
Managing contacts	22	mode	48
Managing your contacts	22	Turning Airplane mode on or off	48
Adding a contact	22	Restarting your smartphone	49
Making calls	24	Adjusting settings.....	49
Before making a call	24	Activating or deactivating connections.....	49
Making a call	25	Mobile network settings	51
Dialing a number from call history.....	25	Smartphone settings.....	52
Viewing missed calls	25	Sound	53
Making a call to one of your contacts.....	26	Display	53
Dialing an international number	26	Setting the date and time.....	54
Direct dial widget.....	26	Setting alarms	54
Answering or declining a call	27	Changing language and text options	54
Internet calling	29	Connecting to a PC.....	55
Adding an internet calling account.....	29	Synchronization	55
Editing or removing an internet calling		FM radio.....	56
account	29	Applications (apps)	56
Using internet calling	29	Closing an app	56
Receiving internet calls.....	29	Uninstalling an app	57
Calling a contact's internet calling		Restoring to factory settings	57
address.....	30	Accessories and tips	58
Calling a phone number using internet		Using the headset.....	58
calling	30	Using a Bluetooth headset.....	58
		Creating a new access point.....	58

Inserting a microSD card	59	Taking care of your smartphone.....	69
Managing your SIM cards	60	Specifications	71
SIM Management.....	60	Performance	71
Appendix	63	Display	71
FAQ and troubleshooting	63	Multimedia	71
Other sources of help.....	65	USB connector.....	71
Warnings and precautions	66	Connectivity	72
Medical devices	67	Camera	72
Vehicles	68	Expansion	72
Potentially explosive environments.....	68	Battery	72
Emergency calls.....	69	Dimensions	73
		End User License Agreement	74

SETTING UP

Unpacking your smartphone

Your new smartphone comes packed in a protective box. Carefully unpack the box and remove the contents. If any of the following items is missing or damaged, contact your dealer immediately:

- Your new Acer smartphone
- USB cable
- AC adapter
- Headset



Note

In-box content varies depending on country and region.

Getting to know your smartphone

Views

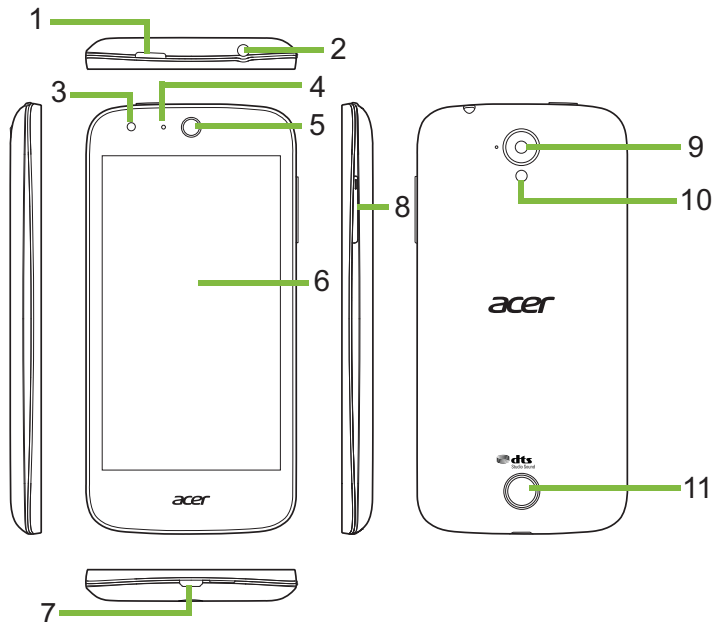

No.	Item	Description
1	Power button	Press to turn the screen on/off or enter sleep mode; press and hold to turn the smartphone on or off.
2	3.5 mm headphone jack	Connects to stereo headphones.
3	Front-facing camera	Use for self-portrait images and online video chat.
4	LED indicator	Indicates the phone's charge status and if there are any messages needing your attention.
5	Smartphone speaker	Emits audio from your smartphone; suitable for holding to your ear.
6	Touchscreen	Capacitive touchscreen to display data, smartphone content and enter information.
7	Micro USB connector	Connects to a USB cable/charger.
8	Volume up/down button	Increases or decreases the smartphone volume.
9	Rear camera	A camera for taking high-resolution images.
10	Flash	LED flash for camera.
11	Handsfree speaker	Emits audio from your smartphone; suitable for handsfree use.

Charging the battery

For initial use, you need to charge your smartphone for eight hours. After that you can recharge the battery as needed.

Connect the AC adapter cord to the micro USB connector on your smartphone.

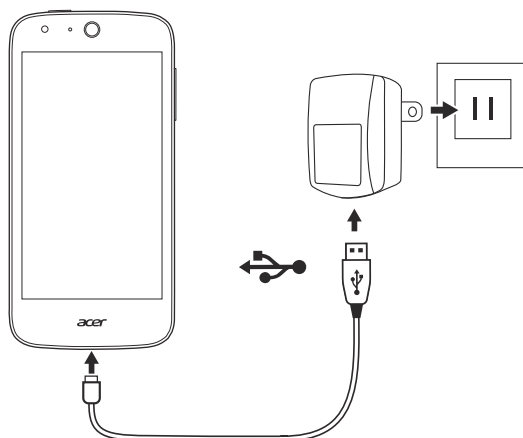

Installing a SIM or microSD card

To take full advantage of your smartphone's telephony capabilities, you must install a SIM card.

Your new smartphone has multiple SIM card holders; install any combination of SIM cards.

Additionally, you may wish to increase your smartphone's storage by inserting a microSD card into the labeled slot.

1. Turn off the smartphone by pressing and holding the power button.

2. Insert your fingernail into the notch located at the bottom of the phone and remove the cover as illustrated. .

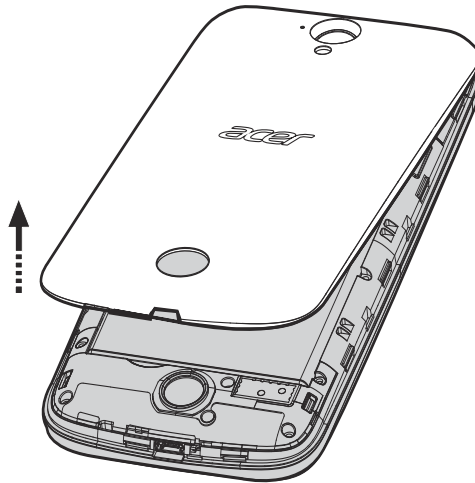

3. Insert the SIM or microSD card as shown.

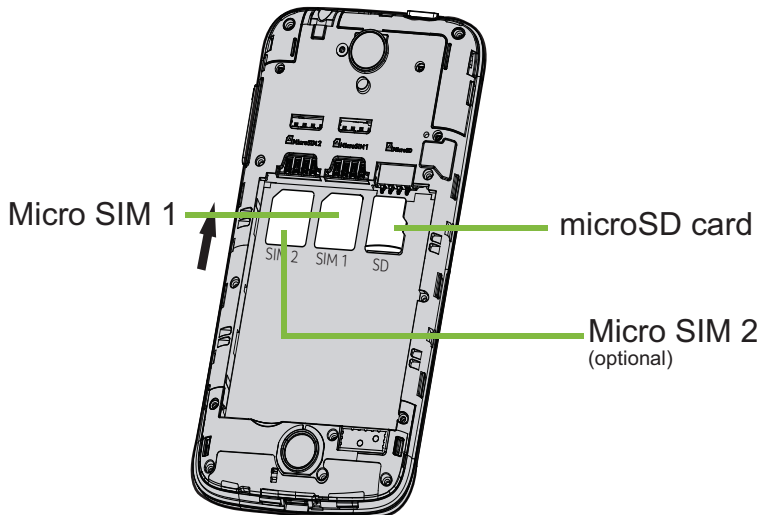

Note: Your smartphone may be equipped with one or two SIM slots depending on model.

4. Align the gold-colored connectors on the battery with the connectors at the top of the battery compartment and insert the battery.

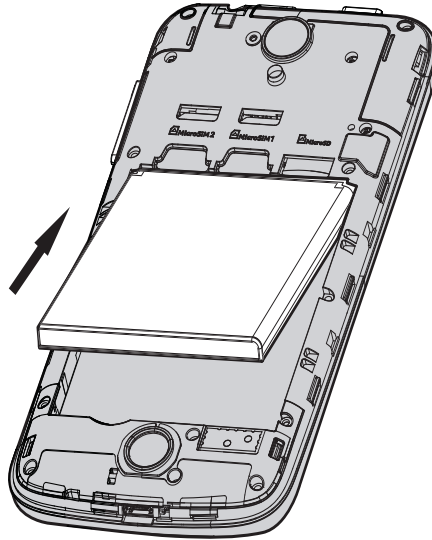

5. Replace the cover by aligning the tabs on the cover into the slots on the phone. Gently press the cover until it snaps in place.

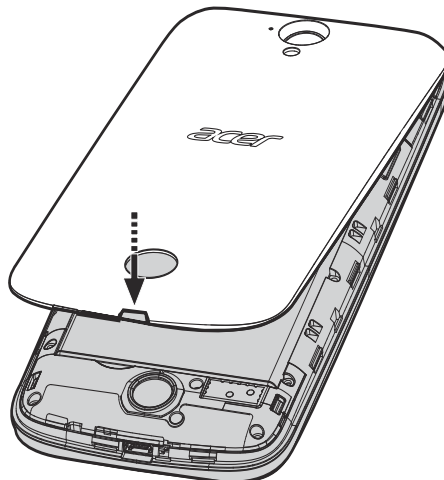

SIM card lock

Your smartphone may come with a SIM card lock, i.e., you will only be able to use the SIM card provided by your network operator.

To cancel the SIM lock, contact your network provider.

USING YOUR SMARTPHONE

Turning on for the first time

To turn on your smartphone for the first time, press and hold the power button until the screen turns on. You will then be asked to configure some settings before you can use your smartphone.

Follow the onscreen instructions to complete setup.

Sign in to or create a Google account

If you have internet access, your smartphone allows you to synchronize information with a Google account.

You may create or sign in to an existing Google account, which will be used to synchronize your contact list, email, calendar and other information. Open the *Application menu* and then tap **Settings** > **Accounts** > **Add account**. Tap the type of account you want to add (e.g. Google). You will need internet access to complete the synchronization process. You can create and easily access multiple Google accounts.

Entering your PIN

When you install a SIM card for the first time, you may need to enter a PIN using the onscreen number pad.



Important

Depending on your settings, you may be required to enter your PIN each time you switch on the phone function.

Activating a new SIM card

If you are using your SIM card for the first time, it may require activation. Contact your network operator for details on how to do this.

Locking your smartphone

If you will not use your smartphone for a while, briefly press the power button to lock access. This saves battery power and ensures your smartphone does not unintentionally use any services. Your smartphone will lock automatically if it is not used for one minute (depending on your settings).

Waking your smartphone

If the screen is off and the smartphone does not react to any taps on the screen, then it has been locked and is in sleep mode.

Press the power button to wake your smartphone. Unlock your smartphone by sliding your finger from the bottom of the screen to the top. Unlock and access the phone by sliding your finger from the left of the screen to the right. Unlock and access the camera by sliding your finger from the right of the screen to the left.

For additional security, you may set an unlock pattern, a set of dots that must be touched in the correct order to access the smartphone. Open the *Application menu* and then tap **Settings > Security > Screen lock**.

If you forget your unlock pattern, please refer to [Unlock pattern on page 65](#).

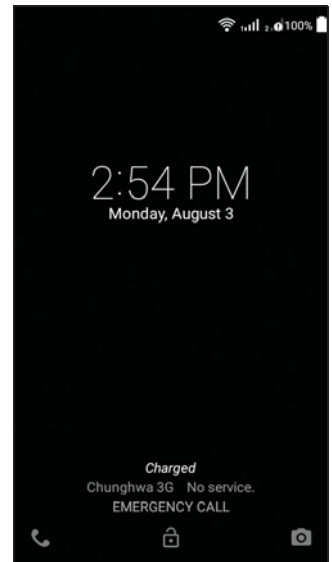

Navigating through menus and options

To navigate through menus and options, there are three buttons beneath the screen.



Back

Home

Menu

Back

Tap this button to go to the previous page, or to go up one level in a menu.

Home

Tap this button to go directly to the *Home screen*. Tap and hold this button, then drag your finger to the *Google* balloon that appears to open *Google Now* (if available) or *Search*.

Menu

Tap this button to see recently opened apps. Tap an app to open it. Swipe left or right on an app to remove the app from the recently opened apps list. **See Multitasking on page 21.**

Using the touchscreen

Your smartphone uses a touchscreen for selecting items and entering information. Use your finger to tap the screen.

Tap: Touch the screen once to open items and select options.

Drag: Hold your finger on the screen and drag across the screen to select text and images.

Tap and hold: Tap and hold an item to see a list of actions available for that item. On the pop-up menu that appears, tap the action you want to perform.

Scroll: To scroll up or down the screen, simply drag your finger up or down the screen in the direction that you want to scroll.

Onscreen keyboards



Note

The keyboard layout varies slightly, depending on the application and information that is required.

Google keyboard

This is a standard onscreen QWERTY keyboard that allows you to enter text. Tap and hold a key with numbers at the top to select alternative characters, such as letters with accents.

Tap the **?123** button to see numbers and special characters, and then tap the **=\<** key to see even more.



You can choose another input language by tapping and holding the comma. Alternatively, you can open the *Application menu* and then tap **Settings > Language & input**. The keyboard layout changes according to the selected language.

To set up multiple languages, tap **Google Keyboard > Languages**. Tap and disable *Use system language*. Under *Active input methods*, tap and enable the languages you want to add to your keyboard.

After setting up more than one language, the world button appears next to the space bar. Tap this button to quickly toggle between multiple input languages. The language being used is indicated on the space bar.



Text assistance

The Android keyboard has various features that assist you to enter correct text. In the *Application menu*, tap **Settings > Language & input**. Then tap *Android Keyboard*. From here you can enable or disable several keyboard-related settings.

Changing the text input method

To change the input method, in the *Application menu* tap **Settings** > **Language & input** > **Current keyboard** and then select your preferred input method.

Predictive text

Android keyboard provides predictive text input for the browser. As you tap the letters of a word, a selection of words are displayed above the keyboard that continue the sequence of letters tapped, or are a close match allowing for errors. The word list changes after every key press. If the word you need is displayed, you can tap on it to insert it into your text.

The Home screen

The *Home screen* gives you quick access to information and simple controls with widgets or shortcuts. These display information such as the time and weather, or provide additional controls and direct access to apps and other frequently used features of your smartphone.

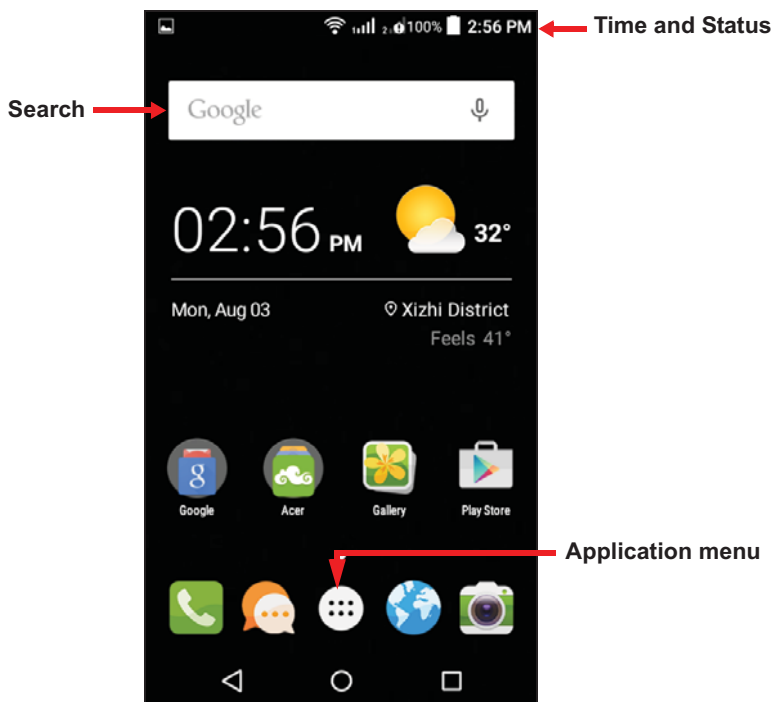

At the bottom of the screen is the *application dock* which displays default apps. Tap an icon to open the app. Tap the *Application menu* icon in the middle of the *application dock* to view your apps. To change apps, [see Changing application dock icons on page 18](#).

Search

To search for apps, files or for information on the internet, tap the **Google** icon.

Enter the text you want to find and tap  or tap one of the suggestions, apps or files shown in the list.

In order to search or browse the internet, you must be connected to a cellular data (if available) or wireless network. [See Going online on page 35](#).

Voice search

If voice search is available, tap the microphone and speak your search request. [See Voice search on page 37](#). 

The extended *Home screen*

When apps are added to the *Home screen*, the *Home screen* extends to either side of the screen, giving you more room to add icons, widgets or features. To view the extended screen, slide your finger to the left or right.

Personalizing the *Home screen*

You may personalize your *Home screen* by adding or removing app shortcuts or widgets, and by changing the wallpaper.

Adding and removing shortcuts and widgets

To add shortcuts, tap the *Application menu* to see a list of apps you can drag to a *Home screen*.

To add widgets, tap and hold anywhere on the home screen. Tap **WIDGETS** to see a list of widgets you can drag to a *Home screen*.

Widgets are small apps that display constantly-updated information or quick shortcuts to apps or special functions.

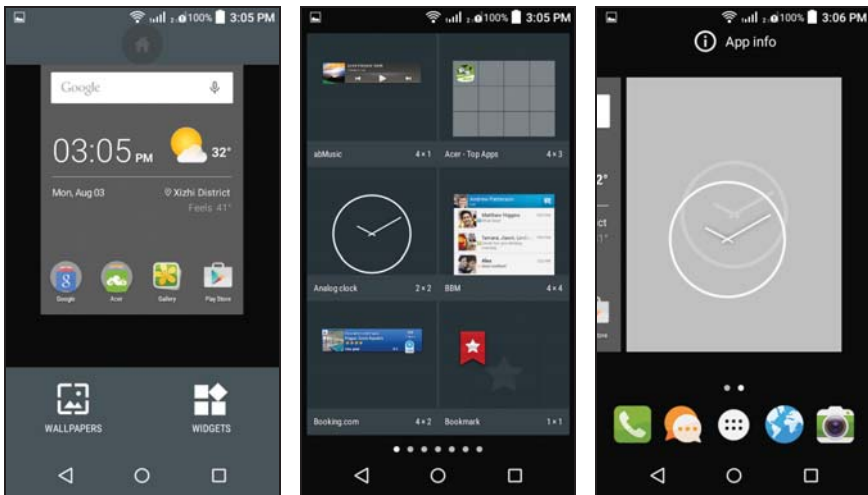

To move an app or widget to the *Home screen*, tap and hold an item until it is selected. The *Home screen* will open. Drag the item to any free area on the screen.

To move the item to a different *Home screen*, drag it to the side of the screen, the *Home screen* will switch to the screen in that direction. Release the item when it is positioned correctly.

To remove a shortcut or widget from the *Home screen*, tap and drag it to **Remove** at the top of the screen.

Resizing widgets

Some widgets can be resized. To resize a widget that is already on the *Home screen*, tap and hold the widget. Once the Remove icon appears, release the widget. If the widget is resizable, you will be able to drag the sides of the widget to resize it.

Adding or removing folders

You can also add folders to your *Home screen*. To create a new folder drag and drop an app icon onto another app icon in the *Home screen*.

This will create an Unnamed Folder. Tap the folder icon and then tap the name of the folder to rename it.

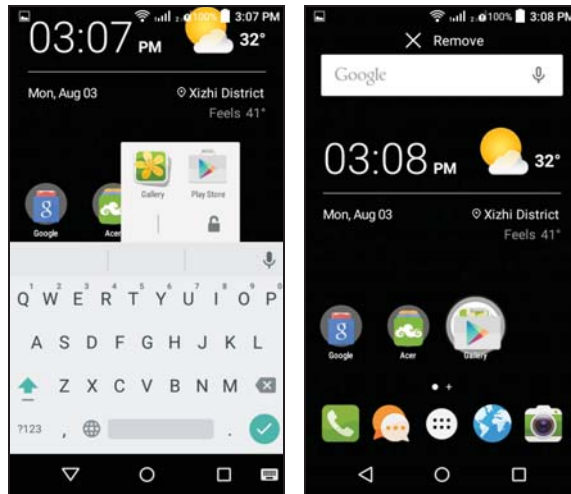

To delete an app shortcut from a folder, tap on the folder icon to display the apps inside and then tap and hold the app icon that you want to remove. Drag and drop the icon on **Remove** that will appear at the top of the screen.

To delete a folder, tap and hold on the folder and then drag and drop the folder on **Remove** that will appear at the top of the screen.

Changing application dock icons

You can set icons for installed apps in the *application dock*. Open the *Application menu* and find the app you want to add. Tap and hold the icon, then drag it to any open position in the dock. Dragging the new app to an existing dock icon will create a folder for both icons.

To remove an icon from the dock, tap and hold the icon to select it. Either drag the icon to a different location outside the dock or **Remove** at the top of the screen.

Changing the wallpaper

In the *Application menu*, tap **Settings** > **Display** > **Wallpaper**. Choose from images stored in the *Gallery*, *Live Wallpapers* (featuring animated or interactive backgrounds), *Photos* or *Wallpapers*.

Alternatively, tap and hold anywhere on the home screen. Tap **WALLPAPERS** to see a selection of images to set as your wallpaper.

The *Application (Apps)* menu

To access the *Application menu*, on the *Home screen* tap  in the center of the dock.

Apps are displayed in alphabetical order. Swipe the page to the left or right to see more apps.

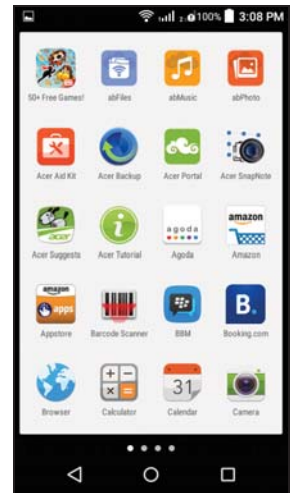

Notification and status area

Notification and status icons are shown at the top of the screen. The top-right area displays a variety of status information, such as Wi-Fi connectivity, signal strength, battery status, and time. The top-left area displays event icons, such as a new message.



Drag the **Notification** area down the screen to view more information about new events. Drag the **Notification** area again to access the *Quick Settings*.

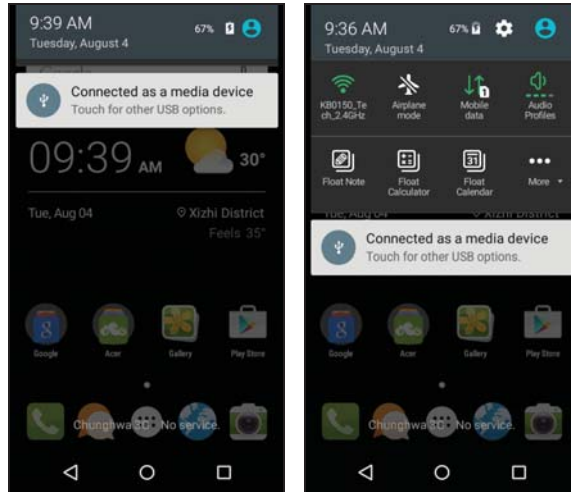

Multitasking

You can have multiple apps open at the same time. To open a new app, tap the home button to return to the *Home screen*, then start the new app. Tap the **Menu** button to quickly navigate back and forth between previously-opened apps.

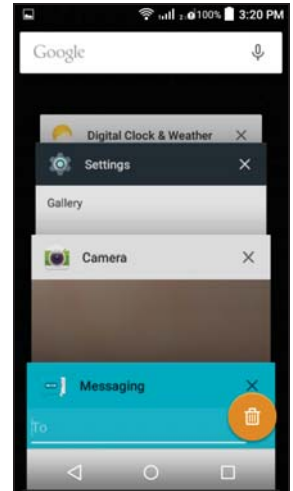

Note

*To extend battery life, it is better to close an app when you've finished using it. Do this by either pressing the **Back** key until it closes or the **Menu** button and selecting **Exit** (if available).*

MANAGING CONTACTS

Managing your contacts

Your smartphone features an address book that allows you to save contacts to either the internal memory or onto your SIM card.

Tap the **Contacts** app from the *Application menu* or tap **CONTACTS** from the *Dialer* to view your contacts.

If you don't have any contacts stored on your smartphone, you can import your Google account contacts, add a new contact or import contacts from your SIM or SD card.

Open the **Contacts** app from the *Application menu* and then tap **+⋮** to add a contact, **Q** to search for a contact, or tap the **Menu** button to open the menu.

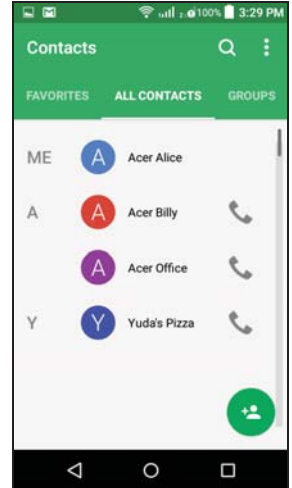

Adding a contact

To add a contact, open the **Contacts** app from the *Application menu* and then tap **+⋮**. Choose an existing account to store the contact to or tap **Add new account** to add a new account.

To create a contact, first choose where you want to store the contact's information. You will then be asked to enter the contact's information, such as name, address, and phone number.

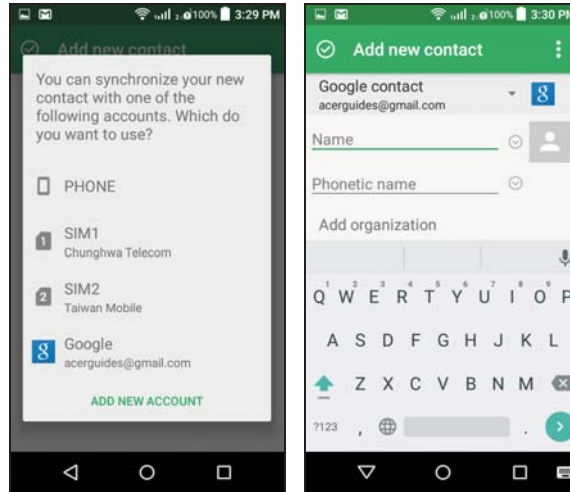

You may scroll down the page and tap **ADD ANOTHER FIELD** to add things such as:

- IM addresses.
- Add any personal notes about the contact.
- Nickname
- Link a website
- Relationship status

To assign an image to your contact, tap the silhouette and select whether to take a photo or select an image from your smartphone's picture gallery.

When done, tap ☺ at the top of the screen.

Tapping on a contact's name will bring up their profile. Tap the pencil icon to edit the contact's information. Tap the menu icon for more options. You may also set a ringtone for the contact, share this contact, or place the contact on your *Home* screen.

You may also create a contact from an already dialed or received number, **see Saving a dialed number to contacts on page 28.**

MAKING CALLS

This chapter shows you how to make phone calls, and the various options available to you during your call.



Before making a call

Check that the smartphone is connected to the network before you make a call. You can confirm the smartphone status from the Notification area.



Note

Status and notification icon colors may vary.



Icon	Description
	Not connected to the network: You are unable to make a call.
	Connected to the network: You may make a call.
	Airplane mode: Wireless connectivity disconnected (Wi-Fi, Bluetooth, and cellular services). Please disable airplane mode before trying to make a call.

Making a call



Note

If you have multiple SIMs inserted in the smartphone, you will be asked which SIM to use before the call is connected. To select a SIM, just tap the name of the carrier.

1. From the *Home* screen tap **Phone** >  to open the onscreen number pad.
2. Enter the number you wish to dial.
3. Tap  to make the call.
4. To end the call, tap .

If the contact you need is displayed, simply tap the contact name to make a call.

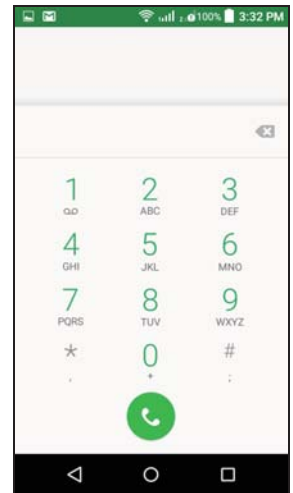

Dialing a number from call history

Your most recent phone activities can be viewed by tapping **RECENTS**. Tap **View full call history** to display all calls, incoming calls, outgoing calls, and missed calls.

To view call details and other options, tap the number or contact's name. Tap **CALL BACK** to call the contact.

Viewing missed calls

Missed call notifications are displayed in the following areas:

1. The Notification area with the missed call  icon. Open the **Notification** area and tap the missed call notification to display the missed call details.
2. On your smartphone's lock screen. Tap the notification and slide to the left or right to display the missed call details.

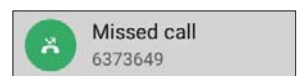

Making a call to one of your contacts

Calling a contact from the Contacts tab

1. Tap the **CONTACTS** tab to view your contacts.
2. Tap on a contact to view the contact's details.
3. Tap on the phone number to call them.

Calling a contact from the Contacts app

1. Tap **Contacts** the *Application menu* to view your contacts.
2. Tap the **ALL CONTACTS** tab to view your contacts.
3. Tap on a contact to view the contact's details.
4. Tap on the contact's phone number to call them.

Dialing an international number

When dialing international numbers, there is no need to enter the international direct dialing prefix ('00' etc.) before the country code. Simply tap and hold 0+ on the onscreen number pad until + appears onscreen.



Important

International call rates can vary greatly depending on the country you are calling and your network provider. We suggest you check all call rates with your network provider, to avoid excessive phone bills. If you are using your smartphone abroad, roaming charges will apply. Consult your network provider for roaming rates specific to the country you are visiting before you leave.



Direct dial widget

You may add a direct dial widget for a contact on your *Home screen*. Open the *Application menu*, then tap the **Widgets** tab. Tap and hold **Direct dial** and you will be able to place the widget on your *Home screen*. Once placed, you will be able to select a contact to associate with that particular widget on your *Home screen*.

Answering or declining a call

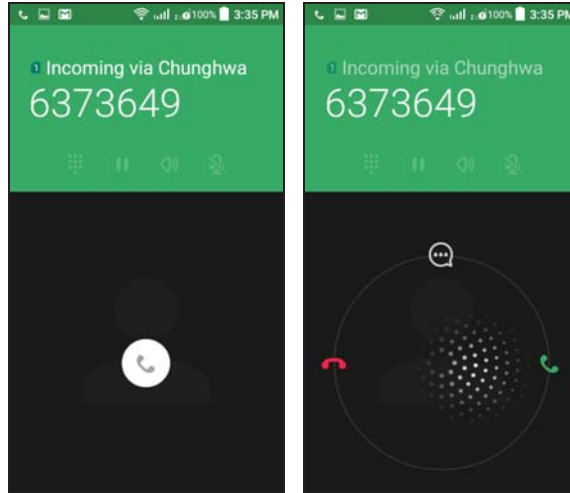
When you have an incoming call and the screen is locked, the number will be shown on the screen. To accept or decline the call, tap the phone icon in the middle and slide your finger across the screen. To decline the call with a text message, slide your finger up and select a message.









When you have an incoming call and the screen is not locked, the incoming call will be minimized and shown at the top. Tap  to decline the call or tap  to accept the call.



Ending a call

To end a call, tap  from the voice call screen.

Voice call options

Icon	Description
	Change to Float Caller mode.
	Speakerphone.
	Mute a call.
	Access the keypad while a call is in progress.
	Place the call on hold.
	Tap to add a second call or record the call.

Saving a dialed number to contacts

You can save a number you have dialed to your contacts for future use.

1. From the *RECENTS* tab in your contacts, tap the number and then tap **DETAILS**.
2. Tap the menu icon > **Edit number before call** > **Add to contacts**.
3. Tap **Create new contact** and enter the information. **See Adding a contact on page 22.**

INTERNET CALLING

You can place and receive internet calls over a wireless network.

Adding an internet calling account

From the *Home screen*, tap **Phone**. If open, tap the **Back** button to close the onscreen number pad. Tap the **:** then **Settings > Call settings > Phone account settings**.

Under *Internet call settings*, tap **Internet calling (SIP) accounts**. Tap **ADD ACCOUNT** to add an internet calling account.

Enter the **Username**, **Password**, and **Server** information. You can also configure optional settings such as *Authentication username*, *Display name*, *Outbound proxy address*, *Port number*, *Transport type*, and *Send keep-alive*.

Editing or removing an internet calling account

Open an existing internet calling account and make the edits you want on the SIP account details. Tap **Save** to save your changes, tap **Discard** to discard the changes, or tap the **Menu** button and then select **Remove account** to delete the existing account.

Using internet calling

You can configure your smartphone to use internet calling (when you're connected to Wi-Fi) for all calls, only for internet calls, or to ask each time you place a call.

Receiving internet calls

Once you have created an internet calling account, you can toggle off and on the internet calling feature on your smartphone. From the *Home screen*, tap **Phone**. If open, tap the **Back** button to close the onscreen number pad. Tap **:** then **Internet Call**. Enable internet calling by tapping **Use Internet calling**.

Calling a contact's internet calling address

You must add an internet calling address to a contact to be able to place an internet call to them.

To make an internet call, from the *Application menu* tap **Contacts**. Tap on the contact to open their profile, and then tap on their internet calling address to place the call.



Note

Many modern internet calling apps automatically "connect" to any of your Android contacts who also have that service. Any connected services will be listed under "connections" in the contact's profile.

Calling a phone number using internet calling

If you have configured your smartphone to place all calls using internet calling or to ask for each call, you may also call a phone number using internet call, whenever you are connected to a wireless network.

Dial the number and tap , or select the contact you wish to place a call to, then tap the internet call account you want to use to make the call.



Important

Calling a phone number using internet calling requires that your service provider supports it, and may incur additional charges. Please contact your service provider if you have any questions.

MESSAGING

This chapter shows you how to set up and use the **Messaging** functions of your smartphone.

All SMS and MMS messages are accessed via **Messaging**. Messaging automatically arranges received and sent messages into threads.

To access Messaging, open the *Application menu* > **Messaging** or tap **Messaging** on the *Home screen*.



Note

If you have multiple SIMs inserted in the smartphone, you will be asked which SIM to use before the message is sent. To select a SIM, just tap the name of the carrier.

Creating a new message

You can use your smartphone to compose text (SMS) and multimedia (MMS) messages.

1. Tap to compose a new message.
2. Tap to add contacts from your contacts list, or tap the **Type name or number** field to enter the recipient's phone number or name directly. Suggested contacts will be displayed in a drop-down list below the text field. To select a suggested contact, tap the contact's name.

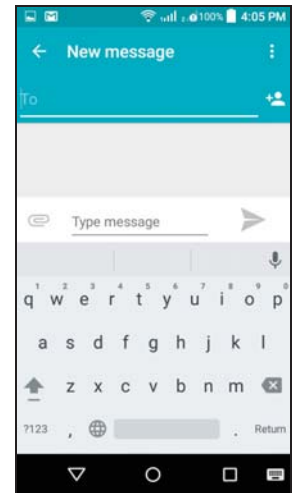

3. Enter your message in the text box labeled **Type message**.



Note

Text messages may be up to 160 characters long. If your message is longer than 160 characters, it will be sent as multiple linked messages. Most phones will automatically join the linked messages to present the recipient with a single long message, however, some older phones do not have this ability.

Tap the menu button to see what options are available when creating a new message. The options change depending on the status of the message.

Option	Description
Add subject	Add a subject to the message.
Discard	Discard the message.
Settings	Additional settings for messages.

Replying to a message

When a new text message arrives a message icon appears in the Notification area and the message icon at the bottom of the smartphone displays the number of unread text messages.

Tap **Messaging** from the *Application menu* to view the message list or open the **Notification** area to see a summary of the message. Tap the summary to open the message list.

To reply to an SMS or MMS message, open the message from the message list. Enter your text in the text box labeled **Type message**. Tap the *Menu* button to see more options.

Option	Description
Add subject	Add a subject to the message.
Send	Send a reply to the message.
Delete thread	Delete the message.
Add to Contacts	Add the sender to your contacts list.
Chat settings	Additional settings for messages.

Multimedia messages

Multimedia messages are similar to text messages but also allow you to attach files such as pictures, audio or video clips. Each message can be up to 300 KB in size.



Note

You need to set up an MMS profile before you can send MMS messages. Normally, your smartphone will set up the profile for you based on information retrieved from your provider.

Ask your network provider for the necessary information if you need to manually set up the MMS profile.

Receiving multimedia messages

When a new multimedia message arrives, a message icon appears at the top of the screen and a notification message is displayed.

1. The notification message displays a summary of the message. Tap **View** to view a summary of the message.
2. Tap **Download** to download the message content. Downloads can take a long time, depending on your connection quality. If you reply or open another app, the download will be stopped.



Important

You may be charged to download message content, especially if you are roaming. Please contact your provider if you have any questions.

3. Tap the message to view the content.

4. To reply to the message, enter your text in the text box labeled **Type message** and tap the *Send* icon. Simple text replies will be sent as SMS messages. If you wish to attach a file, tap . You will be presented with a menu of options.
5. When you have finished composing the message, tap the *Send* icon.

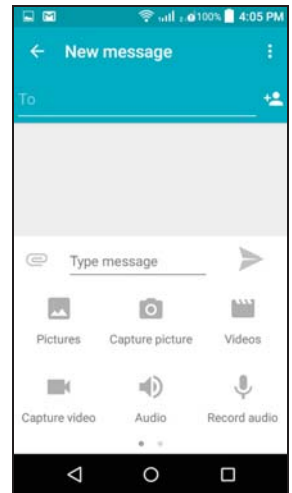

GOING ONLINE

Browsing the internet

In order to browse the internet with your smartphone, you must be connected to a data or wireless network.

Using the browser

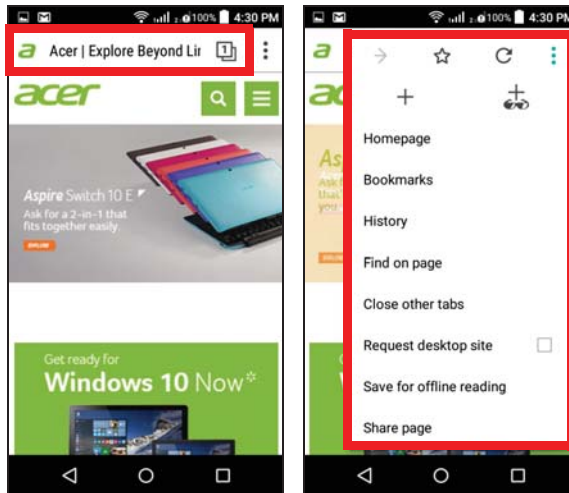

To start browsing tap **Browser** from the application dock.

To open a new website, tap the address box at the top of the page.

Enter the address using the keyboard and tap → . You can zoom in or out of pages by pinching or reverse pinching.

To navigate forward and backward in your browser's history, add and view your bookmarks, see recently-opened tabs, and other options, tap the menu button ⋮ .

Setting up Email

Your smartphone enables you to access your email. Most popular ISPs can be set up in two steps. From the *Application menu* tap **Email** to start setting up your email account.

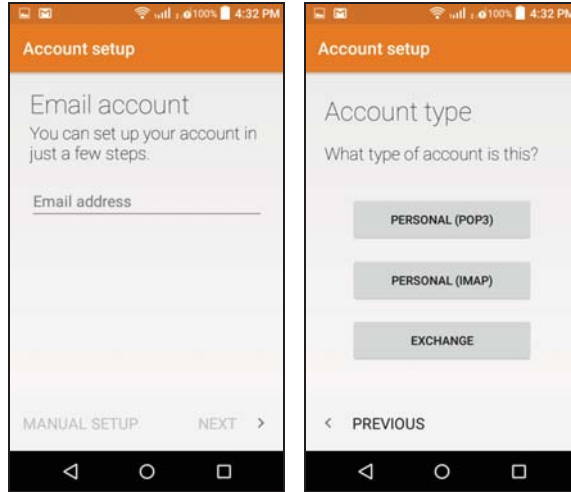

If necessary, enter your email address and tap **MANUAL SETUP** to enter the parameters manually. Tap **Next** to finish the setup process.

Google services



Note

Apps may not be available in all countries and regions.



You must activate a Google account before using Google services. The first time you access Google services, you must read and accept the Terms of Service.

Setting up your Google email

1. Make sure your smartphone is connected to a data or Wi-Fi connection.
2. From the *Application menu* tap **Gmail**.

If you did not enter your Gmail account address and password when you first started your smartphone, follow the onscreen instructions.

Composing an email

1. Make sure your smartphone is connected to a data or Wi-Fi connection.
2. From the *Application menu* tap **Gmail**.
3. Tap  .
4. Enter the recipient's email address, the subject and message.
5. When you are finished composing your message, tap  .

Voice search

With voice actions, you can send text messages, place calls, send emails, find directions of establishments, automatically call establishments, search the internet and even send a note to yourself using your voice. Tap **Voice Search** from the *Application menu*, or tap the *microphone* icon on the *Home screen*.

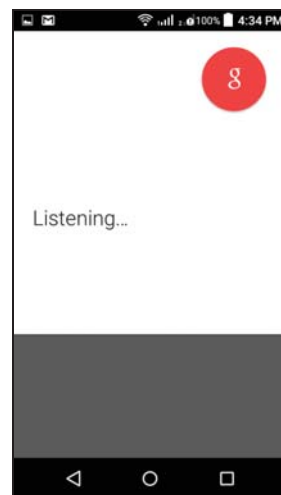

Play Store



Important

For connection issues with Play Store, see [FAQ and troubleshooting](#) on page 63.

Tap **Play Store** from the *Application menu* to open Google Play. Here you can obtain a variety of add-on programs and apps to enhance the functionality of your smartphone.

The contents and design of Google Play varies by region. For example, in some regions, you can also browse for and purchase movies, books, magazines, or music. Updates may add new categories or change how to navigate Google Play at any time.

You can browse the store by category or tap the search icon to search for a specific app.

Once you have selected an app, tap the **Install** button to download and install the app. You will be told which services the app requires access in order to function correctly (e.g. contact information, wireless access, GPS). If none of these services seem unusual, tap **Accept & download** to proceed with the installation.

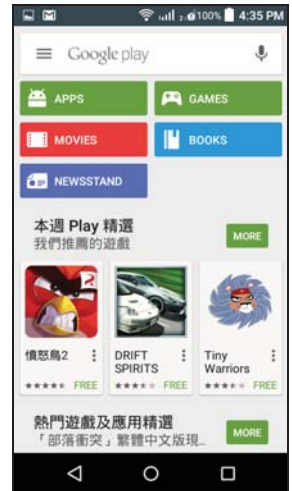

You may keep track of the download progress from both the app's page and the notification area.

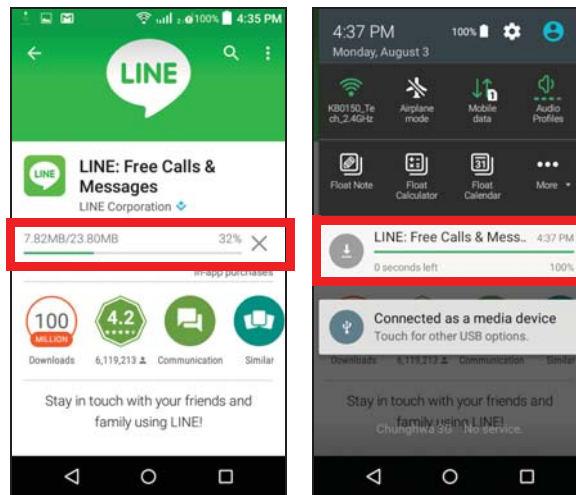

Important

Some apps may require payment before you can download them. You will need to have a Google Wallet account in order to pay for these apps, or a credit card number associated with your Google account.

Using downloaded apps

Once you've downloaded and installed an app, you may find it in the *Application menu* and/or *Widgets* section.

Certain apps provide both an App and widget, or only provide a widget (with no app icon). See [Personalizing the Home screen on page 16](#).

Uninstalling downloaded apps

Once you've downloaded and installed an app, you may uninstall the app by opening the *Application menu* and tapping **Settings > Apps**. In the downloaded tab, select the app you wish to uninstall and tap **Uninstall**. Deleting an app icon from the *Home screen* only deletes the shortcut.

Google Hangouts

Tap **Hangouts** from the *Application menu* to open Google Hangouts. Here you can see a list of your contacts connected to Google Hangouts services. Tap on a contact to open a chat session. After you have connected, you can open a video chat session.

Maps, Navigation, Places and Latitude

Get easy-to-follow directions using Google Maps, view real-time traffic condition and navigate by using spoken, turn-by-turn driving instructions. Also, view where your friends are, places of interest, and local businesses.



Note

Maps does not have information about every location. Some locations may not have all zoom levels.

Using the map

Tap the **Maps** icon in the *Application menu*. Drag the map with your finger to move the map around.

To zoom in or out:

1. Double tap a location on the map to zoom in on the location, and tap once to zoom out, or
2. Touch an area with two fingers at once and spread them apart to zoom in, and pinch them together to zoom out.

USING THE CAMERA

Your smartphone features a digital camera mounted on the front and rear. This section will take you through all the steps in taking photos and videos with your smartphone.

To activate the camera, open the *Application menu* and tap **Camera**.

Camera/camcorder icons and indicators

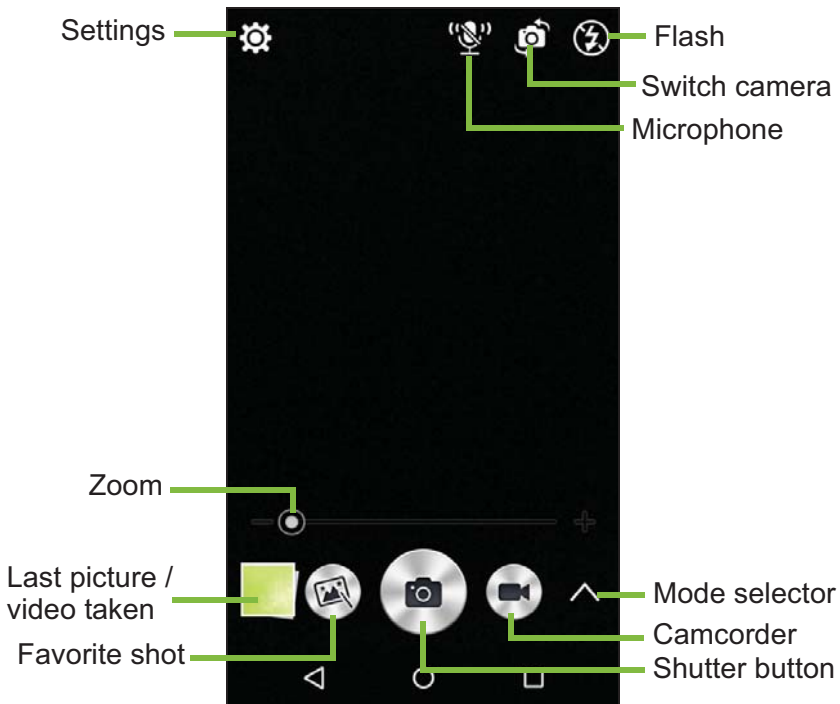

The camera window provides multiple controls on the image screen. Tap the **Shutter** button or press the **volume** key to take a picture. Tap the thumbnail image to open the gallery.

Tap the *Camcorder* button and the camcorder immediately begins filming. While filming, you are unable to access camera/camcorder settings; however, you can still take pictures with the *Shutter* button.

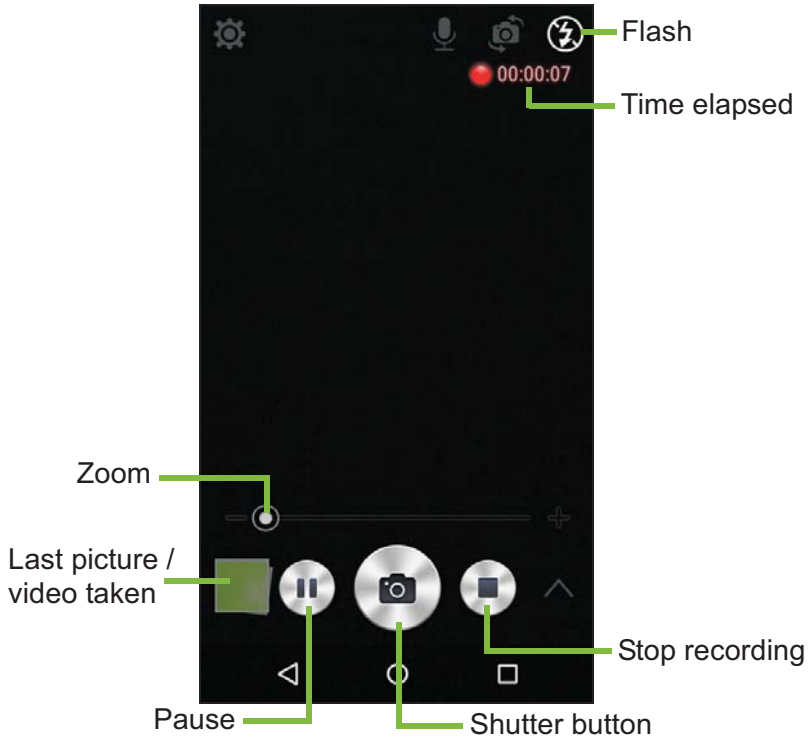

Tap the *Stop recording* button to stop filming.

Mode Selector

Tap the *Mode selector* icon to open the list of modes you can choose from. Tap the icons along the top to select different items.



Camera

Capture mode: Select a capture mode.

Normal	Picture with Sound
HDR	Gourmet
Bright Magic	

Scene mode: Adjust photo parameters for a particular environment.

Off	Night Portrait
Auto	Backlight
Landscape	Backlight Portrait
Night	Portrait

Color effect: Applies a color effect to the image.

None	Negative
Mono	Aqua
Sepia	

Camcorder

The camcorder's scene mode changes depending on the record mode setting (see table below).

Record mode:

Normal	Time lapse
--------	------------

Scene mode:

Off	Night
-----	-------

Effect:

None	Negative
Mono	Aqua
Sepia	

White balance

Compensate for different lighting environments.

Auto	Florescent lamp
Daylight	Incandescent
Cloudy	

Image properties

Adjust the *Brightness, Contrast, Saturation, and Sharpness*.

Self-timer

Set the delay before the shutter is activated.

Settings menus



Note

Some of the following settings are not available for the front camera.

Tap the *Settings* icon to open the *Settings* menu.

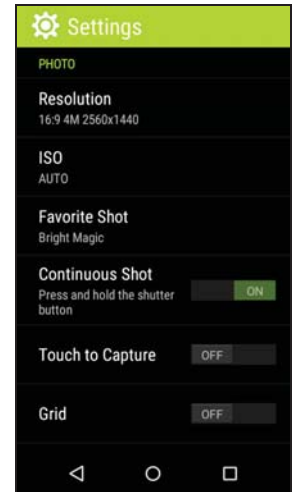

Photo

You may adjust the following:

- Set the **Resolution** and **aspect ratio**.
- Set the **ISO** value.
- Set the default **Favorite shot** mode.
- Turn **Continuous Shot** on or off: Tap and hold the shutter button for continuous images.
- Turn **Touch to Capture** on or off: Touch anywhere on screen to take a picture.
- Turn the onscreen **Grid** on or off.

Video

You may adjust the following:

- Turn **Video stabilizer** on or off.
- Set the video **Resolution**.
- Turn **Audio** on or off.

Other

You may adjust the following:

- Turn GPS **Location** info on or off: Stores GPS information in the image information.
- Turn **Voice Control** on or off.
- Choose to **Reset to default** camera settings.

Taking a photo

1. Ensure you have adjusted the settings described above.
2. Frame your subject and steady your smartphone.
3. Zoom in or out as needed.
4. Tap the **Shutter** button to take a picture.

Shooting a video

1. Frame your subject and steady your smartphone and zoom in or out as needed.
2. Tap the **Camcorder** button to start taking a video. Tap the **Pause** or **Stop recording** buttons.

Supported formats



Note

To see supported image, video, and audio formats, see **Multimedia on page 71**.

Viewing photos and videos

After you have taken your photo or video, it is automatically saved. Once you have taken a photo or video, you can view it in *Gallery* by tapping the thumbnail in the corner of the image screen. Alternatively, open the *Application menu* and tap **Gallery**. From Gallery you can share the file directly using various services. Services vary depending on the file type.

You may also edit individual photos you have taken by tapping the  icon in the lower left-hand corner of the image.

Geotagging

Geotagging allows you to store the location where a photo or video was taken right in the photo or video itself.

For the geotag to display, pictures must be taken with **GPS Location** info turned on.

ADVANCED SETTINGS

Putting your smartphone in Airplane mode

You can enable Airplane mode (also known as flight mode) to turn off cellular, Wi-Fi and Bluetooth functions and use your smartphone as a handheld device during a flight. Check with your airline to make sure this is permitted onboard.

Switch your smartphone off during takeoff and landing as it may interfere with aircraft electronic systems.

Turning Airplane mode on or off

There are two ways to turn Airplane mode on or off:

1. Press and hold the power button until you see the shut down menu.
2. Tap **Airplane mode**.

-OR-

1. Open the **Notification** area.
2. Tap **Airplane mode**.

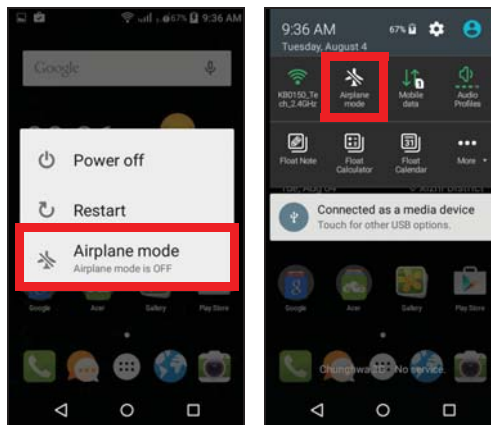

Note

When Airplane mode is active, the ✈ icon will be displayed in the Notification area.

Restarting your smartphone

You can restart (reboot) your smartphone if you find apps are not responding. Press and hold the power button until you see the shut down menu, then tap **Restart**. Open the rear cover, then remove and replace the battery. Press the power button to restart the phone.

Adjusting settings

Activating or deactivating connections

Open the *Application menu* and tap **Settings** to manage your connection settings.

Item	Description
Wi-Fi	Turn the Wi-Fi function on or off.
Bluetooth	Turn the Bluetooth function on or off.
SIM cards	Set a default SIM for particular functions (such as voice calling or messaging), turn the data connection on or off, set roaming preferences and associate contacts with a SIM.
Data usage	View an estimate of the mobile data used for each SIM.
Call settings	Configure your phone account settings.

Item	Description
More...	<p>Access additional connection settings:</p> <p>Airplane mode: Disable all wireless connections so you can safely use this device onboard an aircraft.</p> <p>Default SMS app: Choose which app serves as the default SMS app.</p> <p>Tethering & portable hotspot: Share your smartphone's mobile data connection via USB or as a portable Wi-Fi hotspot.</p> <p>VPN: Set up and manage Virtual Private Networks.</p> <p>Mobile networks: Set your options for connecting to mobile networks.</p> <p>Cell broadcasts: Configure cell broadcast SMS settings.</p>

If your smartphone is in Airplane mode, the option to turn Bluetooth on will be disabled. Please refer to [Putting your smartphone in Airplane mode on page 48](#) for instructions on turning Airplane mode on or off.

Adjusting Bluetooth settings

You can use Bluetooth to exchange information between your smartphone and other mobile devices.

Bluetooth connections

For all Bluetooth settings, open the *Application menu* and tap **Settings > Bluetooth**. Here you can switch Bluetooth on or off, set a device name and discoverability. Tap the **Menu > Refresh** to scan for available devices.

To connect to a device, tap the device in the list of available devices. You may be asked to enter a PIN on both devices to establish the connection.

To simply turn on or off Bluetooth, open the **Notification** area and tap the **Bluetooth** button.

Internet sharing

Tethering via USB

If you wish to share your mobile internet connection with a computer, you can connect your smartphone to a PC using the supplied USB cable.

1. Plug the USB sync cable into the micro USB connector on your smartphone.
2. Plug the USB client connector into an available USB port on your computer.
3. Push the **Menu** button and then tap **Settings > More > Tethering & portable hotspot**.



Note

Your smartphone must first be connected to a PC using the USB cable in order to enable and disable USB tethering. If your smartphone is not connected to a PC, USB teathering will be automatically disabled.

Wi-Fi hotspot

You can turn your smartphone into a portable Wi-Fi hotspot to share your mobile internet connection with up to 8 clients.

1. In the *Application menu* tap **Settings > More > Tethering & portable hotspot**. Turn *Wi-Fi hotspot* **ON**. Tap **Wi-Fi hotspot > Set up Wi-Fi hotspot**.
2. Set the Network SSID and adjust security between None and WPA2 PSK. Tap **Save** to finish.



Note

When your smartphone is serving as a Wi-Fi hotspot, you can't use your smartphone's apps to access the internet via its Wi-Fi connection.

Mobile network settings

In the *Application menu* tap **Settings > More > Mobile networks** to adjust your network settings.

Selecting a network

Your smartphone will automatically detect your carrier/network settings when you insert a new SIM card. However, you may prefer to manually select a network. This may be a good idea when roaming.



Note

When you are traveling, manually selecting a network may help to reduce your roaming charges. Check with your home service provider for the network offering the most competitive rates at your destination.

1. Open the *Application menu* and tap **Settings > More > Mobile networks** to view your network settings.
2. Your smartphone display the network settings for the installed SIM.
3. Tap **Preferred network type** and select your preferred network from the list generated. Your smartphone will attempt to register on the selected network.

-OR-

Tap **Auto** to connect to the available network with the strongest signal. This may lead to your smartphone jumping between networks when you move around.



Note

Contact your service provider should you have any problems obtaining voice mail and the text message service center numbers.

Data usage control settings

Data usage controls let you monitor total usage by network type and app and then set limits if needed.

Ensure Wi-Fi or mobile data is enabled before setting a limit. Access data usage settings from the *Application menu* by tapping **Settings > Data usage**.

Smartphone settings

Many smartphone settings are automatically configured by your smartphone when you insert a SIM card. The device will communicate with your provider and automatically obtain all necessary settings, such as network name, voice mail and text message center numbers.

You can also view and modify these settings manually through the Call settings screen.

From the *Home screen*, tap **Phone**, then tap the **Menu** button > **Settings**. Tap which settings you want to modify.

Sound

To adjust your smartphone's sound settings, in the *Application menu* tap **Settings** > **Sound & notification**.

Item	Description
Volumes	Adjust the <i>Media music</i> , <i>Alarm volume</i> , and <i>Ring volume</i> .
Vibrate	Vibrates the device for incoming calls.
Interruptions	Sets your interruptions priorities.
Phone ringtone	Sets your default voice calls ringtone.
Default notification ringtone	Set your smartphone's default notification ringtone.
Other sounds	Enable or disable <i>Dial pad tones</i> , <i>Screen locking sounds</i> , <i>Touch sounds</i> and <i>Vibrate on touch</i> .

Adjusting the volume

Adjust the volume of your smartphone using the volume button on the side of the smartphone. Alternatively, you can set the *Media*, *Alarm* and *Ring* volume by opening the *Application menu* and tapping **Settings** > **Sound & notification**.

Display

To adjust your smartphone's display settings, in the *Application menu* tap **Settings** > **Display**.

Item	Description
Brightness	Adjust screen brightness.
Adaptive brightness	Optimizes brightness level for available light.
Bluelight Shield	Set the brightness level for reading.
Wallpaper	Change the <i>Home screen's</i> wallpaper.

Item	Description
Sleep	Adjust the delay before the screen automatically turns off.
Daydream	Controls what happens when the smartphone is docked and/or sleeping.
Font size	Change the default font size for the UI.
When device is rotated	Enable rotation of the screen when device is tilted.

Setting the date and time

To set the date and time, open the *Application menu* and tap **Settings** > **Date & time**.

If you travel frequently or live in an area that uses daylight saving time, activate **Automatic date & time** > **Use network-provided time** from this menu. This will enable your smartphone to set the date and time based on information it receives from the network.

Setting alarms

There are two predefined alarms on your smartphone by default. Tap **Clock** in the *Application menu*, and then tap  to edit alarm settings. You may:

- Turn the alarm on or off.
- Set the alarm time.
- Set which days to repeat the alarm.
- Set a ringtone.
- Enable or disable vibrate.
- Give it a label.

Changing language and text options

Set your location and language input preferences by opening the *Application menu* and going to **Settings** > **Language & input**.

Connecting to a PC

If you wish to transfer information between your device and your computer (either the microSD card in your device or the device's internal memory), you can connect your device to a PC using the supplied USB cable.

1. Plug the USB sync cable into the micro USB connector on your smartphone.
2. Plug the USB client connector into an available USB port on your computer.
3. Open the notification area and ensure your USB connection method says *Connected as a media device*. Your device will now be available as a drive in your computer's file explorer. Tap **Connected as a media device** to choose other connection methods.

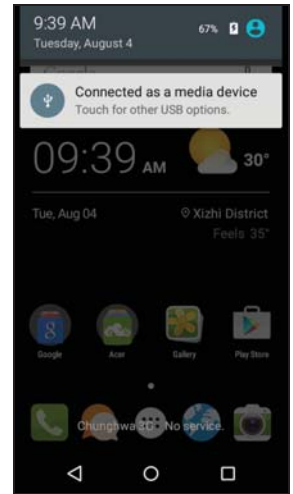

Note

After turning on USB storage, you will not be able to access the files in the microSD card or apps such as Gallery or Music.

Synchronization

You can sync your calendar, email and contacts on your smartphone and never worry about losing them again. Sync in real time or adjust it as you please. In the *Application menu*, tap **Settings**. Under ACCOUNTS, tap the appropriate account and again under ACCOUNTS tap that account's email address to access the synchronization settings.

To add a new account, tap **Add account**. Select the type of account and then follow the onscreen instructions.

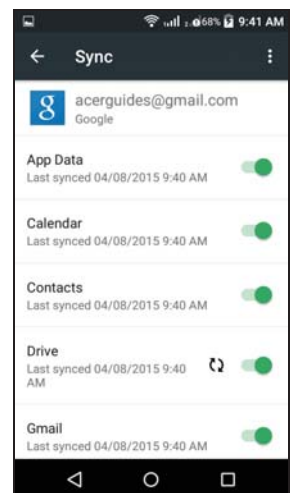

Google Sync

In Google, you can set synchronization for Google services. In your Google account's synchronization settings menu, tap the checkmark next to the item you would like to have auto-sync. Tap again to uncheck any for manual synchronization.

To manually synchronize an item, make sure the item is checked, tap the **Menu** button and then tap **Sync now**.



Note

You need a Google account to sync your calendar and appointments.

FM radio

The FM radio allows you to listen to your favorite stations while on the move. Headphones must be inserted to the 3.5 mm jack as the cable functions as an antenna.

You can access the radio by tapping **FM Radio** from the *Application menu*.

Tap the back icon to turn the radio off.



Applications (apps)

Closing an app

To close an active app, in the *Application menu* tap **Settings > Apps**. Swipe over to the **Running** tab, then tap the program you wish to close. Select **STOP** to close the program.

Uninstalling an app

You can remove programs installed on your smartphone to free up extra storage memory.

1. In the *Application menu* tap **Settings** > **Apps**.
2. Swipe over to the **Downloaded** tab.
3. Find the app in the list and tap on it.
4. Tap **UNINSTALL** and then tap **OK**.



Important

You should only remove programs if you are familiar with the Android operating system.

Restoring to factory settings

You may perform a clean boot to restore your smartphone to the factory settings. Before performing a clean boot, ensure that your smartphone is not locked. Press any key or tap the screen to see if the smartphone responds.



Important

You should only perform a clean boot when all other options have failed to restore your smartphone to an operational state. This will erase all your personal information, any contacts stored on your smartphone and any programs you installed.

If your smartphone is responding to screen input, then open **Settings** from the *Application menu*. Tap **Backup & reset** > **Factory data reset** > **RESET PHONE** and then **ERASE EVERYTHING** to format your smartphone.

ACCESSORIES AND TIPS

This chapter shows you how to use accessories with your smartphone, as well as provide useful tips for when you are using your smartphone.

Using the headset

Your smartphone is compatible with headsets with a built-in microphone for handsfree use when making calls.

To use the headset, plug it into the 3.5 mm headphone jack at the top of the smartphone.

When the headset is plugged in, all audio is routed to the headset, and the speakers are turned off.

- To answer an incoming call, press the button on the headset.
- Adjust the volume using the volume up/down button on the smartphone.
- End the call by pressing the button again.

Using a Bluetooth headset

Your smartphone's Bluetooth functions make it fully compatible with all Bluetooth headsets. This allows you to use the unit handsfree when making calls, without the inconvenience of wires.

Creating a new access point

When you need to add another GPRS/3G/4G/EDGE connection on your smartphone, obtain the access point name and settings (including username and password if required) from your wireless service provider.

1. Open the *Application menu* and tap **Settings > More > Mobile networks > Access Point Names**, and select an operator.
2. Tap the **Menu** button and then tap **New APN**.
3. Enter the APN settings. Tap an item to adjust it.

4. When you have finished tap the **Menu** button and then tap **Save**.



Important

Some providers and countries do not allow the use of a smartphone as a modem over HSDPA. Please check with your provider before attempting to do so.

Inserting a microSD card

Your smartphone features a memory expansion slot that accepts a microSD card to expand memory and storage capacity.

Please refer to **Installing a SIM or microSD card on page 7** for instructions on installing a microSD card.

MANAGING YOUR SIM CARDS



Note

This chapter is for models with more than one SIM card.

SIM Management

Open the *Application menu* and tap **Settings** > **SIM management**. From this screen, you can:

1. Enable or disable each SIM.
2. Tap the SIM name to configure each SIM's name and number.
3. Set the default SIM for *Mobile data*.
4. Set the default SIM for your *Calls* and *SMS messages* or select **Ask first** to always ask which SIM you want to use.

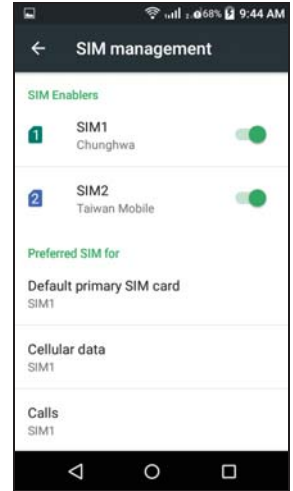

Selecting which SIM to use when making a call

If you have set *Calls* to **Always ask**, you will be asked which SIM to use each time you make call. Enter the number, then tap . A dialog opens; tap the SIM to use and the call will be connected.

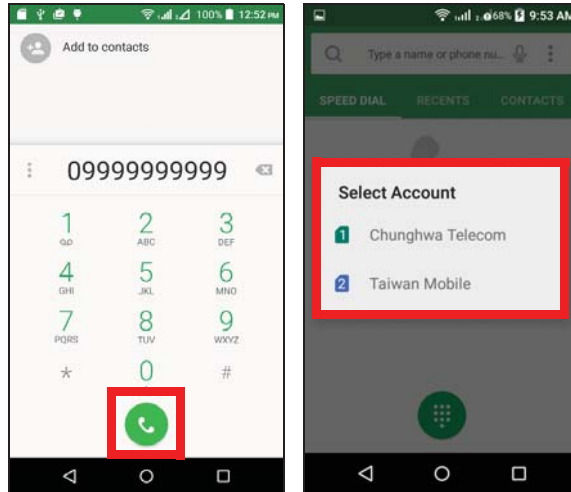

Selecting which SIM to use when sending a text message

If you have set *SMS Messages* to **Always ask**, you will be asked which SIM to use each time you send a text message. Enter the message and recipient information, then tap the **Send** button. A dialog opens; tap the SIM to use and the message will be sent.

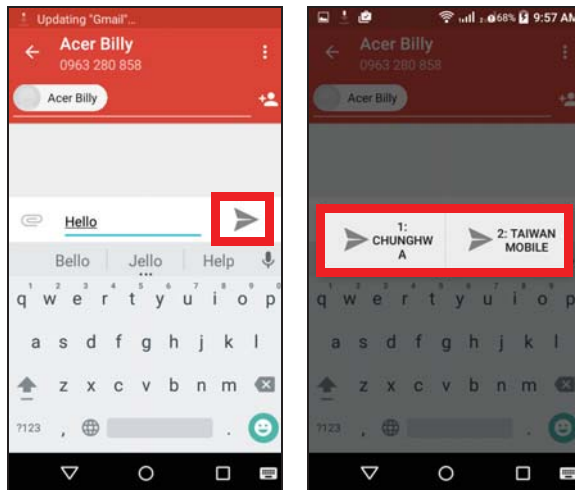

Identifying calls

Whenever you receive a call, the caller's number will be shown. You will also be shown the name of the SIM receiving the call.

In the call log, the name of the SIM will be shown beneath the number of the call -- whether the call was missed, answered or was an outgoing call.

Limitations when using multiple SIMs

When a SIM is:	Other SIMs cannot:
In a call	Dial out
Ringing	Receive a call (caller will get a "number not available" message)
Sending or receiving a message	Send or receive a message
Using a data connection	Use a data connection



Note

If you are using data on one SIM and you make or receive a call, or send or receive a text message on another SIM, the first SIM's data connection will be temporarily halted.

APPENDIX

FAQ and troubleshooting

This section lists frequently asked questions that may arise during the use of your smartphone, and gives easy answers and solutions to these questions.

Aspect	Question	Suggestions
Audio	Why is there no sound coming from the device?	If the headset is plugged into the device, the speaker is automatically shut off. Disconnect the headset. Check that the device volume setting is not muted. Check that the volume control is not at its lowest setting.
Multimedia files	Why can't I view my picture files?	You may be trying to view an image that is not supported. See Multimedia on page 71.
	Why can't I view my video files?	You may be trying to view a video that is not supported. See Multimedia on page 71.
	Why can't I play my music files?	You may be trying to play a file that is not supported. See Multimedia on page 71.

Aspect	Question	Suggestions
Google Play Store	Why can't I connect to the Play Store?	<p>1. First check that you have a Wi-Fi or data connection and then try again.</p> <p><i>Some Wi-Fi "hotspots" require you to log in before accessing the internet.</i></p> <p>2. If you still cannot connect, try adjusting your date/time settings. Open the <i>Application menu</i> and tap Settings > Date & time > Automatic date & time set to <i>off</i>.</p> <p>3. Manually adjust the time and date then try to reconnect to the Play Store (change the time/date back after connecting).</p>
System information and performance	How do I check the OS version of my device?	Tap Settings > About phone to check the OS version (Build number) and other hardware and software information.
Power	I can't turn on the device.	The battery power may be depleted. Recharge the device. See Charging the battery on page 6 for more information.
RAM / ROM	How do I check the RAM and ROM memory status?	To check the ROM status, tap Settings > Storage . To check RAM status, tap Settings > Apps > RUNNING .
Internal storage	My device's available internal storage is full or almost full.	Uninstall apps to increase available storage. See Uninstalling an app on page 57 .

Aspect	Question	Suggestions
Unlock pattern	I forgot my unlock pattern.	<p>After a certain number of wrong entries, you will be presented with an option to reset your pattern. Tap Forgot pattern? and enter your Google account username and password.</p> <p><i>You must have an active Google account on the smartphone. Alternatively, you restore your smartphone to factory settings. See Restoring to factory settings on page 57.</i></p>
Heat	The smartphone heats up when charging or making long duration calls.	<p>It is normal for the smartphone to heat up when charging. When charging is complete, it will return to its normal temperature.</p> <p>It is also normal for the smartphone to heat up during long periods of use, such as watching a video or a long smartphone conversation.</p>

Other sources of help

For information on	Refer to ...
Up-to-date information regarding your smartphone	www.acer.com mobile.acer.com
Service enquiries	www.acer.com/support

WARNINGS AND PRECAUTIONS

- Do not use this product near water.
- Do not place this product on an unstable cart, stand or table. If the product falls, it could be seriously damaged.
- Slots and openings are provided for ventilation to ensure reliable operation of the product and to protect it from overheating. These openings must not be blocked or covered. The openings should never be blocked by placing the product on a bed, sofa, rug or other similar surface. This product should never be placed near or over a radiator or heat register, or in a built-in installation unless proper ventilation is provided.
- Never push objects of any kind into this product through cabinet slots as they may touch dangerous voltage points or short-out parts that could result in a fire or electric shock. Never spill liquid of any kind onto or into the product.
- To avoid damage of internal components and to prevent battery leakage, do not place the product on a vibrating surface.
- Never use this product when engaging in sporting activities, exercising, or in any vibrating environment which may cause a short circuit or damage, and even a risk of explosion from the battery pack.

Protecting your hearing

To protect your hearing, follow these instructions.

- Increase the volume gradually until you can hear clearly and comfortably.
- Do not increase the volume level after your ears have adjusted.
- Do not listen to music at high volumes for extended periods.
- Do not increase the volume to block out noisy surroundings.
- Decrease the volume if you can't hear people speaking near you.

Additional safety information

Your device and its enhancements may contain small parts. Keep them out of the reach of small children.

Operating environment



Important

For safety reasons, turn off all wireless or radio transmitting devices when using your smartphone device under the following conditions. These devices may include, but are not limited to: wireless LAN (WLAN), Bluetooth and/or cellular devices.

Remember to follow any special regulations in force in any area, and always switch off your device when its use is prohibited or when it may cause interference or danger. Use the device only in its normal operating positions. To successfully transmit data files or messages, this device requires a good quality connection to the network. In some cases, transmission of data files or messages may be delayed until such a connection is available. Ensure that the above separation distance instructions are followed until the transmission is completed. Parts of the device are magnetic. Metallic materials may be attracted to the device, and persons with hearing aids should not hold the device to the ear with the hearing aid. Do not place credit cards or other magnetic storage media near the device, because information stored on them may be erased.

Medical devices

Operation of any radio transmitting equipment, including wireless smartphones, may interfere with the functionality of inadequately protected medical devices. Consult a physician or the manufacturer of the medical device to determine if they are adequately shielded from external RF energy or if you have any questions. Switch off your device in health care facilities when any regulations posted in these areas instruct you to do so. Hospitals or health care facilities may be using equipment that could be sensitive to external RF transmissions.

Pacemakers. Pacemaker manufacturers recommend that a minimum separation of 15.3 cm (6") be maintained between wireless devices and a pacemaker to avoid potential interference with the pacemaker. These recommendations are consistent with the independent research by and recommendations of Wireless Technology Research. Persons with pacemakers should do the following:

- Always keep the device more than 15.3 cm (6") from the pacemaker.

- Not carry the device near your pacemaker when the device is switched on. If you suspect interference, switch off your device, and move it.

Hearing aids. Some digital wireless devices may interfere with some hearing aids. If interference occurs, consult your service provider.

Vehicles

RF signals may affect improperly installed or inadequately shielded electronic systems in motor vehicles such as electronic fuel injection systems, electronic anti-skid (anti-lock) braking systems, electronic speed control systems, and air bag systems. For more information, check with the manufacturer, or its representative, of your vehicle or any equipment that has been added. Only qualified personnel should service the device, or install the device in a vehicle. Faulty installation or service may be dangerous and may invalidate any warranty that may apply to the device. Check regularly that all wireless equipment in your vehicle is mounted and operating properly. Do not store or carry flammable liquids, gases, or explosive materials in the same compartment as the device, its parts, or enhancements. For vehicles equipped with an air bag, remember that air bags inflate with great force. Do not place objects, including installed or portable wireless equipment in the area over the air bag or in the air bag deployment area. If in-vehicle wireless equipment is improperly installed, and the air bag inflates, serious injury could result. Using your device while flying in aircraft is prohibited. Switch off your device before boarding an aircraft. The use of wireless teledevices in an aircraft may be dangerous to the operation of the aircraft, disrupt the wireless telephone network, and may be illegal.

Potentially explosive environments

Switch off your device when in any area with a potentially explosive atmosphere and obey all signs and instructions. Potentially explosive atmospheres include areas where you would normally be advised to turn off your vehicle engine. Sparks in such areas could cause an explosion or fire resulting in bodily injury or even death. Switch off the device at refueling points such as near gas pumps at service stations. Observe restrictions on the use of radio equipment in fuel depots,

storage, and distribution areas; chemical plants; or where blasting operations are in progress. Areas with a potentially explosive atmospheres are often, but not always, clearly marked. They include below deck on boats, chemical transfer or storage facilities, vehicles using liquefied petroleum gas (such as propane or butane), and areas where the air contains chemicals or particles such as grain, dust or metal powders.

Follow any restrictions. Do not use the device where blasting is in progress.

Emergency calls



Important

Wireless smartphones, including this device, operate using radio signals, wireless networks, landline networks, and user-programmed functions. Because of this, connections in all conditions cannot be guaranteed. You should never rely solely on any wireless device for essential communications like medical emergencies.

If certain features are in use, you may first need to turn those features off before you can make an emergency call. Consult this guide or your service provider for more information.

When making an emergency call, give all the necessary information as accurately as possible. Your wireless device may be the only means of communication at the scene of an accident. Do not end the call until given permission to do so.

Taking care of your smartphone

1. **DO** take care not to scratch the screen of your smartphone. Keep the screen clean. When working with your smartphone, use your finger or fingernail. Never use an actual pen or pencil or other sharp object on the screen surface.
2. **DO NOT** expose your smartphone to rain or moisture. Do not let water enter the circuitry through the front panel buttons or expansion slots. In general, treat your smartphone as you would a mobile smartphone or other small electronic device.

3. **DO** be careful not to drop your smartphone or subject it to any strong impact. Do not place your smartphone in your back pocket.
4. **DO NOT** expose your smartphone to extreme temperatures. For example, do not leave your smartphone on the dashboard of a car on a hot day or when temperatures are below freezing point. Also, keep it away from heaters and other sources of heat.
5. **DO NOT** use or store your smartphone in any location that is dusty, damp or wet.
6. **DO** use a soft, damp cloth to clean your smartphone. If the surface of the screen becomes soiled, clean it with a soft cloth moistened with diluted window-cleaning solution.
7. **DO NOT** press down on the screen with force, otherwise you may crack the screen.

Specifications



Note

Specifications may vary depending on region and configuration.

Performance

- 1.1 GHz quad-core processor
- System memory:
 - ROM 8 GB eMMC + RAM 1 GB
- Android operating system

Display

- 4.5" TFT LCD, capacitive touchscreen
- 480 x 854 resolution

Multimedia

Formats supported:

Type	Formats
Image	JPEG, GIF, PNG, BMP
Audio playback	MP3, AMR, AAC LC, AAC+, eAAC+, Vorbis, FLAC, MIDI, WAVE
Ringtone	MP3, AMR, AAC LC, AAC+, eAAC+, Vorbis, FLAC, MIDI, WAVE
Video recording	H.263, H.264, MPEG4
Video playback	H.263, H.264, MPEG4, VP8

USB connector

- Micro USB connector
- USB client
- DC power-in (5 V, 1 A)

Connectivity

- Bluetooth 4.0 with LE
- IEEE 802.11b/g/n
- GSM 850 / 900 / 1800 / 1900 MHz
- HSPA / WCDMA*
 - SKU 1: 900 (B8) / 2100 (B1) MHz
 - SKU 2: 850 (B5) / 1900 (B2) MHz
 - SKU 3: 850 (B5) / 1700 (B4 - AWS) MHz
- LTE 800 (B20) / 1800 (B3) / 2100 (B1) / 2600 (B7) MHz
- HSPA+ / GPRS / EDGE
- GPS

*Frequency depends on model.

Camera

- 5 MP rear camera (Auto focus)
- 5 MP front camera (Fixed focus)

Expansion

- microSD memory card slot (up to 32 GB)

Battery

- 2000 mAh Li-polymer battery



Note

Length of battery operation will depend on power consumption which is based on system resource use. For example, constantly using the backlight or using power-demanding apps will shorten battery life between charges.

Dimensions

Height	136 mm
Width	66.5 mm
Thickness	9.8 mm
Weight	142 g (with battery)

END USER LICENSE AGREEMENT

IMPORTANT-READ CAREFULLY: THIS END USER LICENSE AGREEMENT ("AGREEMENT") IS A LEGAL AGREEMENT BETWEEN YOU (EITHER AN INDIVIDUAL OR A SINGLE ENTITY), AND ACER INC. INCLUDING ITS SUBSIDIARIES ("ACER") FOR THE SOFTWARE (WHETHER PROVIDED BY ACER OR BY ACER'S LICENSORS OR SUPPLIERS) THAT ACCOMPANIES THIS AGREEMENT, INCLUDING ANY ASSOCIATED MEDIA, PRINTED MATERIALS AND RELATED USER ELECTRONIC DOCUMENTATION WHICH MAY BE BRANDED "ACER" ("SOFTWARE"). AGREEMENTS RELATING TO ANY OTHER PRODUCT OR TOPIC ARE NEITHER INTENDED NOR SHOULD THEY BE IMPLIED. BY INSTALLING THE ACCOMPANYING SOFTWARE OR ANY PORTION THEREOF, YOU AGREE TO BE BOUND BY THE TERMS AND CONDITIONS OF THIS AGREEMENT. IF YOU DO NOT AGREE TO ALL OF THE TERMS AND CONDITIONS OF THIS AGREEMENT, DO NOT CONTINUE THE INSTALLATION PROCESS AND IMMEDIATELY DELETE ALL INSTALLED FILES, IF ANY, OF THE ACCOMPANYING SOFTWARE FROM YOUR SMARTPHONE.

IF YOU DO NOT HAVE A VALIDLY-LICENSED COPY OF THE APPLICABLE SOFTWARE, YOU ARE NOT AUTHORIZED TO INSTALL, COPY OR OTHERWISE USE THE SOFTWARE, AND HAVE NO RIGHTS UNDER THIS AGREEMENT.

The Software is protected by U.S. and international copyright laws and conventions as well as other intellectual property laws and treaties. The Software is licensed, not sold.

GRANT OF LICENSE

Acer grants to you the following non-exclusive and non-transferable rights with respect to the Software. Under this Agreement, you may:

1. Install and use the Software only on a single designated smartphone. A separate license is required for each smartphone on which the Software will be used;
2. Make one copy of the Software solely for backup or archival purposes;
3. Make one hardcopy of any electronic documents included in the Software, provided that you receive the documents electronically.

RESTRICTIONS

You may NOT:

1. Use or copy the Software except as provided in this Agreement;
2. Rent or lease the Software to any third party;
3. Modify, adapt, or translate the Software in whole or in part;
4. Reverse engineer, decompile, or disassemble the Software or create derivative works based upon the Software;
5. Merge the Software with any other program or modify the Software, except for your personal use; and
6. Sublicense or otherwise make the Software available to third parties, except that you may, after prior written notification to Acer, transfer the Software as a whole to a third party so long as you do not retain any copies of the Software and such third party accepts the terms of this Agreement.
7. Transfer your rights under this Agreement to any third parties.
8. Export the Software in contravention of applicable export laws and regulations, or (i) sell, export, re-export, transfer, divert, disclose technical data, or dispose of, any Software to any prohibited person, entity, or destination including, without limitation, Cuba, Iran, North Korea,

Sudan and Syria; or (ii) use any Software for any use prohibited by the laws or regulations of the United States.

SUPPORT SERVICES

Acer is not obligated to provide technical or other support for the Software.

ACER LIVE UPDATE

Certain of the software contains elements that enable the use of the Acer Live Update service, which allows for updates for such software to be automatically downloaded and installed on your smartphone. By installing the software, you hereby agree and consent that Acer (or its licensors) may automatically check the version of such software that you are using on your smartphone and may provide upgrades to such software that may be automatically downloaded on to your smartphone.

OWNERSHIP AND COPYRIGHT

Title, ownership rights and intellectual property rights in and to the Software and all copies thereof shall remain with Acer or Acer's licensors or suppliers (as applicable). You do not have or shall not gain any proprietary interest in the Software (including any modifications or copies made by or for you) or any related intellectual property rights. Title and related rights in the content accessed through the Software is the property of the applicable content owner and may be protected by applicable law. This license gives you no rights to such contents. You hereby agree

1. Not to remove any copyright or other proprietary notices from the Software;
2. To reproduce all such notices on any authorized copies you make; and
3. To use best efforts to prevent any unauthorized copying of the Software.

TRADEMARKS

This Agreement does not grant to you any rights in connection with any trademarks or service marks of Acer or of Acer's licensors or suppliers.

DISCLAIMER OF WARRANTIES

TO THE MAXIMUM EXTENT PERMITTED BY APPLICABLE LAW, ACER, ITS SUPPLIERS, AND ITS LICENSORS, PROVIDE THE SOFTWARE "AS IS" AND WITH ALL FAULTS, AND HEREBY DISCLAIM ALL OTHER WARRANTIES AND CONDITIONS, EITHER EXPRESS, IMPLIED OR STATUTORY, INCLUDING, BUT NOT LIMITED TO, ANY IMPLIED WARRANTIES, DUTIES OR CONDITIONS OF MERCHANTABILITY, OF FITNESS FOR A PARTICULAR PURPOSE, OF ACCURACY OR COMPLETENESS OF RESPONSES, OF RESULTS, OF WORKMANLIKE EFFORT, OF LACK OF VIRUSES, AND OF LACK OF NEGLIGENCE, ALL WITH REGARD TO THE SOFTWARE AND THE PROVISION OF OR FAILURE TO PROVIDE SUPPORT SERVICES. ALSO, THERE IS NO WARRANTY OR CONDITION OF TITLE, QUIET ENJOYMENT, QUIET POSSESSION, CORRESPONDENCE TO DESCRIPTION OR NON-INFRINGEMENT WITH REGARD TO THE SOFTWARE.

EXCLUSION OF INCIDENTAL, CONSEQUENTIAL AND CERTAIN OTHER DAMAGES

TO THE MAXIMUM EXTENT PERMITTED BY APPLICABLE LAW, IN NO EVENT SHALL ACER, ACER'S SUPPLIERS, OR ACER'S LICENSORS, BE LIABLE FOR ANY SPECIAL, INCIDENTAL, INDIRECT, PUNITIVE, OR CONSEQUENTIAL DAMAGES WHATSOEVER (INCLUDING, BUT NOT LIMITED TO, DAMAGES FOR LOSS OF PROFITS OR CONFIDENTIAL OR OTHER INFORMATION, FOR BUSINESS INTERRUPTION, FOR PERSONAL INJURY, FOR LOSS OF PRIVACY, FOR FAILURE TO MEET ANY DUTY INCLUDING OF GOOD FAITH OR OF REASONABLE CARE, FOR NEGLIGENCE, AND FOR ANY OTHER PECUNIARY OR OTHER LOSS WHATSOEVER) ARISING OUT OF OR IN ANY WAY RELATED TO THE USE OF OR INABILITY TO USE THE SOFTWARE, THE PROVISION OF OR FAILURE TO PROVIDE SUPPORT SERVICES, OR OTHERWISE UNDER OR IN CONNECTION WITH ANY

PROVISION OF THIS AGREEMENT, EVEN IN THE EVENT OF THE FAULT, TORT (INCLUDING NEGLIGENCE), STRICT LIABILITY, BREACH OF CONTRACT OR BREACH OF WARRANTY OF ACER OR ITS SUPPLIERS OR LICENSORS, AND EVEN IF ACER AND ITS SUPPLIERS AND LICENSORS HAVE BEEN ADVISED OF THE POSSIBILITY OF SUCH DAMAGES.

LIMITATION OF LIABILITY AND REMEDIES

NOTWITHSTANDING ANY DAMAGES THAT YOU MIGHT INCUR FOR ANY REASON WHATSOEVER (INCLUDING, WITHOUT LIMITATION, ALL DAMAGES REFERENCED ABOVE AND ALL DIRECT OR GENERAL DAMAGES), THE ENTIRE LIABILITY OF ACER, ITS SUPPLIERS, AND ITS LICENSORS, UNDER ANY PROVISION OF THIS AGREEMENT, AND YOUR EXCLUSIVE REMEDY FOR ALL OF THE FOREGOING, SHALL BE LIMITED TO THE AGGREGATE AMOUNT PAID BY YOU FOR THE SOFTWARE. THE FOREGOING LIMITATIONS, EXCLUSIONS AND DISCLAIMERS (INCLUDING DISCLAIMER OF WARRANTIES AND EXCLUSION OF INCIDENTAL, CONSEQUENTIAL AND CERTAIN OTHER DAMAGES ABOVE) SHALL APPLY TO THE MAXIMUM EXTENT PERMITTED BY APPLICABLE LAW, EVEN IF ANY REMEDY FAILS ITS ESSENTIAL PURPOSE; PROVIDED, HOWEVER, THAT BECAUSE SOME JURISDICTIONS DO NOT ALLOW THE EXCLUSION OR LIMITATION OR LIABILITY FOR CONSEQUENTIAL OR INCIDENTAL DAMAGES, THE ABOVE LIMITATION MAY NOT APPLY TO YOU.

TERMINATION

Without prejudice to any other rights, Acer may immediately terminate this Agreement without notice if you fail to comply with any terms and conditions of this Agreement.

In such event, you must:

1. Cease all use of the Software;
2. Destroy or return to Acer the original and all copies of the Software; and
3. Delete the Software from all smartphones on which it was resident.

All disclaimers of warranties and limitation of liability set forth in this Agreement shall survive termination of this Agreement.

GENERAL

This Agreement represents the complete agreement between you and Acer relating to this license for the Software and supersedes all prior agreements, communications, proposals and representations between the parties and prevails over any conflicting or additional terms of any quote, order, acknowledgement or similar communication. This Agreement may only be modified by a written document signed by both parties. If any provision of this Agreement is held by a court of competent jurisdiction to be contrary to law that provision will be enforced to the maximum extent permissible and the remaining provisions of this Agreement will remain in full force and effect.

ADDITIONAL PROVISIONS APPLICABLE TO THIRD PARTY SOFTWARE AND SERVICES

Software provided hereunder by Acer's licensors or suppliers ("Third Party Software") is made available to you for your personal, non-commercial use only. You may not use the Third Party Software in any manner that could damage, disable, overburden, or impair the services provided by Acer's licensors or suppliers hereunder ("Third Party Services"). Furthermore, you may not use the Third Party Software in any manner that could interfere with any other party's use and enjoyment of the Third Party Services, or the services and products of Acer's licensors' or suppliers' third party licensors. Your use of the Third Party Software and Third Party Services is also subject to additional terms and conditions and policies which can be accessed through our global website.

Privacy policy

During registration you will be asked to submit some information to Acer. Please refer to Acer's privacy policy at www.acer.com or your local Acer website.

TRADEMARK INFORMATION

DTS Studio Sound



For DTS patents, see <http://patents.dts.com>. Manufactured under license from DTS Licensing Limited. DTS, the Symbol, & DTS and the Symbol together are registered trademarks, and DTS Studio Sound is a trademark of DTS, Inc. © DTS, Inc. All Rights Reserved.