



# Table of contents

Package contents.....	2
Getting started.....	3
Description of the device.....	4
Through the wizard.....	5
Connecting to a WiFi network.....	6
The Android™ interface.....	8
ARCHOS Fusion Storage.....	12
Getting familiar with Android™.....	14
Troubleshooting.....	16

For more information, please consult the FAQs on [www.archos.com](http://www.archos.com). Make sure to read them before considering any product return. Your deal may be no big deal. As we are often updating and improving our products, your device's software may have a slightly different appearance or modified functionality than presented in this Quick Start Guide. Consult the declaration of conformity on [http://www.archos.com/products/declaration\\_conformity.html](http://www.archos.com/products/declaration_conformity.html)





# Package Content

---



ARCHOS 101c Platinum



QSG booklet



Warranty,  
legal & safety booklet



USB cable

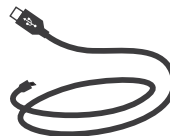

Charger





# Getting Started

## Charging

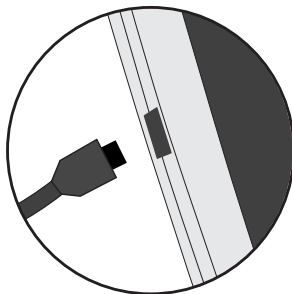

1. Charge your device by plugging your power cable into the power connector. The ARCHOS device will start charging.
2. Press the Power button to turn on the device.

- You can use your ARCHOS whilst it charges.
- Let your device charge completely the first time you use it.
- Use only the supplied charger.

**When your device is completely discharged, you need to charge it for at least 10 minutes before the charging battery icon can be displayed.**

### TIP:

To receive more complete service, please register your product.  
From a computer, go to [www.archos.com/register](http://www.archos.com/register).





# Description of the device

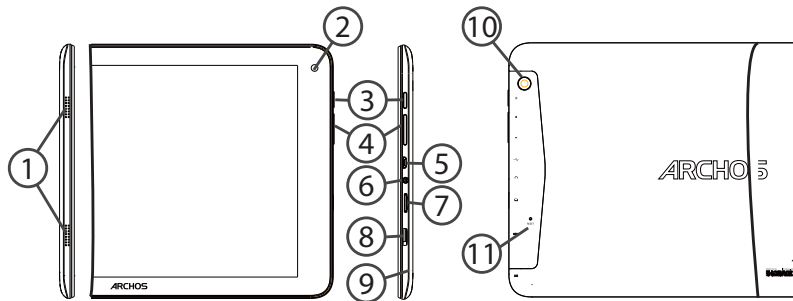

- |                  |                      |                |
|------------------|----------------------|----------------|
| ① Loudspeaker    | ⑤ Micro-USB port     | ⑨ Microphone   |
| ② Webcam         | ⑥ Headphone jack     | ⑩ Reset button |
| ③ ON/OFF button  | ⑦ Micro-SD card slot | ⑪ Camera       |
| ④ Volume buttons | ⑧ Mini-HDMI          |                |





# Through the Wizard

The first time you start up your ARCHOS, the installation wizard will help you set up your device:

- Language
- WiFi connection
- Date & time
- Your name
- Location service options
- 3rd party apps

**TIP:**

We recommend that you set up your device in the WiFi zone of the network that you will regularly be using.







# Connecting to a WiFi Network

**WARNING:** Make sure that you are in a WiFi zone.

You can access the WiFi settings quickly from the status bar.

1. Touch and pull down the status bar to display it.
2. Touch again the bar to reveal the quick settings.
3. Select the WiFi icon  to activate the WiFi connection .
4. Select "WiFi" below the WiFi icon.

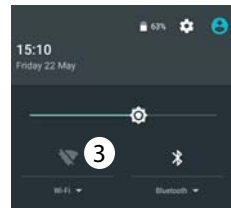

5. Touch the name of network you want to connect to. Private networks are shown with a lock icon and will require you to enter your password.

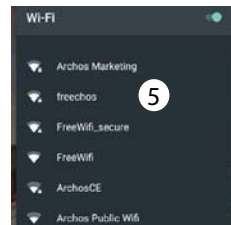

## TIPS:

- When entering a WiFi password, we recommend that you select "Show password" so you can see the characters you are typing. To get the correct WiFi password (or settings) for the network, contact the WiFi network provider. If your WiFi is on and you are in range of a network that you previously connected to, your ARCHOS will automatically attempt to connect to it.
- To keep your WiFi connection ON when the device is on sleep, select the Menu icon in the "WiFi" page. Then, select Advanced > Keep WiFi on during sleep > Always.





## Connecting to WiFi using WPS

1. Touch and pull down the status bar to display it.

2. Touch again the bar to reveal the quick settings.

3. Select the WiFi icon  to activate the WiFi connection .

4. Select "WiFi" below the WiFi icon.

5. Select the Menu button , then Advanced.

6. Select WPS Push Button.

7. Press the WiFi Protected Setup button on your router. It may be called "WPS" or contain a symbol: .

Wi-Fi

Add network

Saved networks

Refresh

Advanced

Wi-Fi Direct

WPS Push Button

WPS Pin Entry

# The Android™ Interface

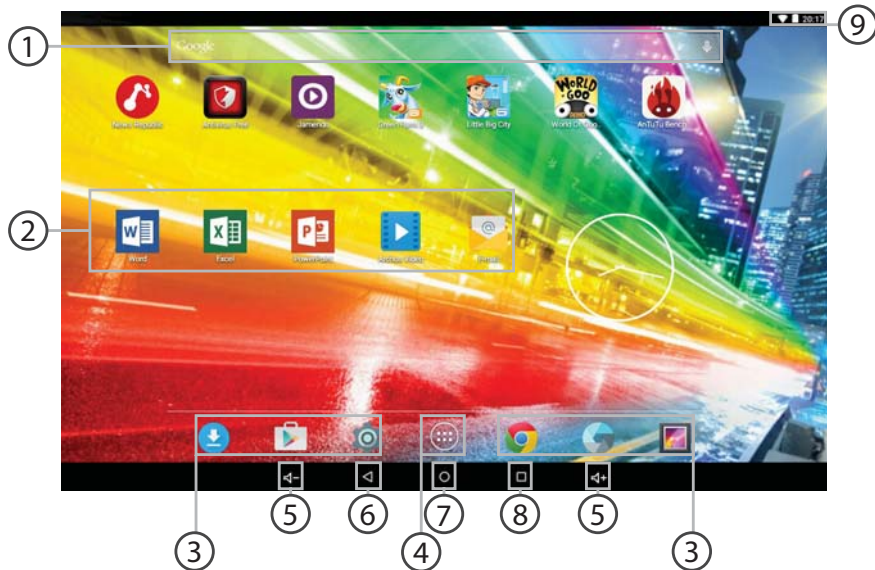





- ① **Google™ Search**  
> Touch "Google" for text search or touch the microphone icon for voice search.
- ② **Android™ apps shortcuts**  
> Touch to start an application.
- ③ **Permanent Android™ apps shortcuts**  
> Touch to start an application
- ④ **All Apps button**  
> Touch this icon to show all the applications and widgets installed on your ARCHOS. All your downloaded applications are here.
- ⑤ **Volume buttons**
- ⑥ **Back button**
- ⑦ **Home button**
- ⑧ **Recent apps buttons**
- ⑨ **The status bar**  
> Displays notifications and quick settings



# The Android™ Interface

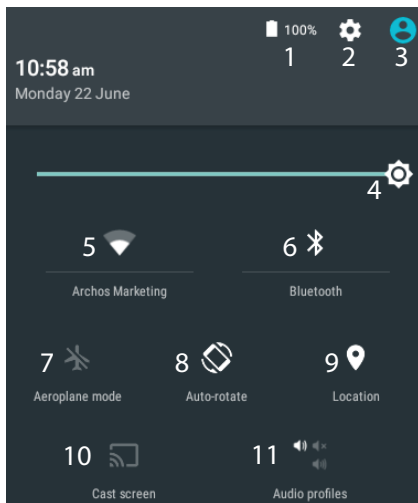

## The Quick settings

- 1 Percentage of battery remaining
- 2 To access all your settings.
- 3 Current user\*
- 4 To adjust the screen brightness.
- 5 To turn on/off your WiFi connection.
- 6 To turn on/off your Bluetooth connection.
- 7 To activate/deactivate all wireless connections, especially when flying.
- 8 To activate/deactivate automatic screen orientation as you turn your ARCHOS.
- 9 Location services
- 10 To mirror your Android device to the TV so you can enjoy your great content exactly as you see it on your mobile device.
- 11 To select a notification type

\*New multi-user support for tablets lets different users have their own separate, customizable spaces on a single device. Add users in Settings > Device.



## The Recent Apps

Opens a list of thumbnail images of apps you've worked with recently:

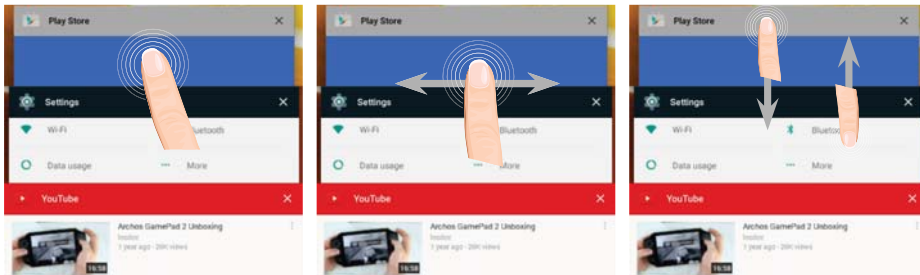

**Touch:** to open an app.

**Swipe left or right:** to close an app.

**Scroll up or down:** to view other recent apps





# ARCHOS Fusion Storage

## Setting up fusion storage

1. Insert a micro-SD card in the device's micro-SD card slot.  
Make sure to insert the card in the right direction.

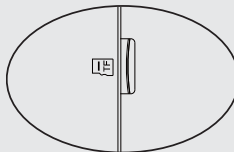

Your device will detect the micro-SD card automatically and offers you to merge the internal storage with the micro-SD card.

2. Select "OK".

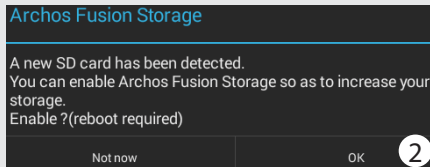

3. Select "OK" in the Optimizing storage window to confirm your choice.

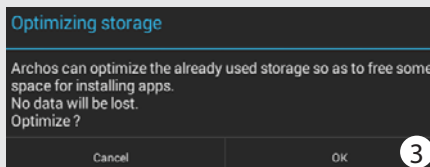



The device will reboot.

- When the device restarts, you are informed that the ARCHOS Fusion storage is active.
- In the status bar, a notification is displayed.
- Select the Settings app, then ARCHOS Fusion Storage. The merged storage is displayed.

### Disabling fusion storage

1. Select the Settings app.
  2. In the Settings app, select ARCHOS Fusion Storage.
  3. When the ARCHOS Fusion Storage is active, select “Disable ARCHOS Fusion Storage” and confirm.
- Your device will reboot in order to apply the changes.

#### OPTIONS

Disable Archos Fusion Storage  
Get back to the initial configuration

### Tip:

We recommend you to turn off the device before inserting the micro-SD card.





# Getting familiar with Android™



## Moving a home screen item:

Touch and hold your finger onto it until the positioning gridlines appear, then slide it to the desired location, and release your finger.

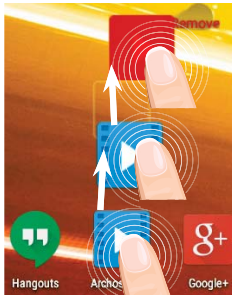

## Removing a home screen item:

Touch and hold it, slide your finger towards the top of the screen and drop it over the Remove icon.



## Uninstalling an item:

From the All apps screens, touch and hold it, slide your finger towards the top of the screen and drop it over Uninstall bin.





### Creating application folders:

Drop one app icon over another on a home screen and the two icons will be combined.



### Changing your wallpaper:

Hold your finger on a home screen at an empty location, then choose from the list: Wallpaper.



### Widgets:

Hold your finger on a home screen at an empty location, then choose from the list: Widgets.





# Troubleshooting

---

## **If your device is frozen:**

Press the ON/OFF button for 10 seconds.

## **If your device doesn't turn on:**

1. Charge your device.
2. Press the ON/OFF button for 10 seconds.

## **If you want to extend the life of your battery:**

Decrease the screen brightness and turn off the wireless connections if not in use.

## **If your device functioning is too slow:**

Close all apps which are not currently used.

## **If your WiFi reception is too low:**

Make sure you are not far from the WiFi hotspot.

Update the firmware of the device: <http://www.archos.com/support>.

Reset and redefine your connection parameters.

Contact your WiFi connection provider.







# Table des matières

Contenu de la boîte.....	18
Mise en route.....	19
Description de l'appareil.....	20
Assistant de démarrage.....	21
Se connecter à un réseau WiFi.....	22
L'interface Android™.....	24
ARCHOS Fusion Storage.....	28
Se familiariser avec Android™.....	30
Dépannage.....	32

Pour plus d'informations, consultez-les FAQs sur [www.archos.com](http://www.archos.com). Consultez-les avant d'envisager un éventuel retour du produit. Le problème que vous rencontrez peut être résolu facilement. Comme nous mettons à jour et améliorons régulièrement nos produits, le logiciel de votre appareil peut présenter une interface ou des fonctionnalités légèrement différentes de celles décrites dans ce guide.

Consultez la déclaration de conformité sur [http://www.archos.com/products/declaration\\_conformity.html](http://www.archos.com/products/declaration_conformity.html)





# Contenu de la boîte



ARCHOS 101c Platinum



Guide d'utilisation rapide



Guide des garanties et des mentions  
légales



Câble USB

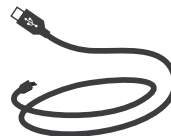

Chargeur





# Mise en route

## Charger la batterie

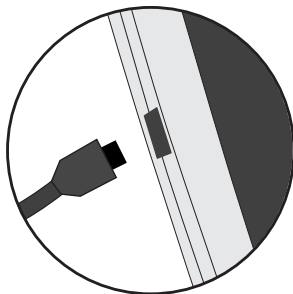

1. Connectez le câble d'alimentation à votre produit via le connecteur d'alimentation.

La tablette commence à se charger.

2. Appuyez sur le bouton On/Off pour allumer l'appareil.

- Vous pouvez utiliser votre tablette pendant le chargement.

- Lors de la première utilisation, chargez complètement la batterie.

- Utilisez uniquement le chargeur fourni.

**Lorsque votre tablette est complètement déchargée, il faut la laisser charger pendant 10 minutes minimum avant que l'icône de charge ne puisse s'afficher.**

### ASTUCES:

Pour bénéficier d'une assistance complète, enregistrez votre produit.

A partir de votre ordinateur, allez sur [www.archos.com/register](http://www.archos.com/register).





# Description de l'appareil

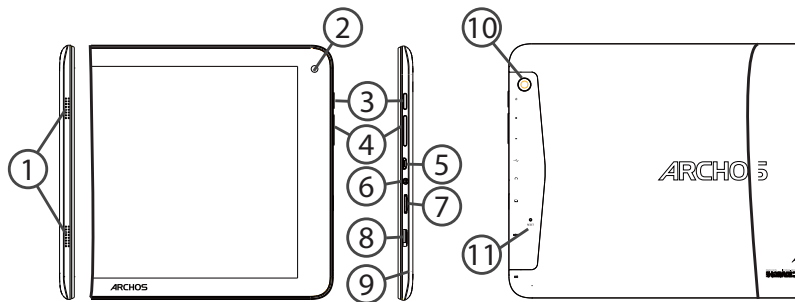

- |                     |                          |                   |
|---------------------|--------------------------|-------------------|
| ① Haut-parleurs     | ⑤ Port micro-USB         | ⑨ Micro           |
| ② Webcam            | ⑥ Entrée jack audio      | ⑩ Caméra          |
| ③ Bouton ON/OFF     | ⑦ Lecteur carte micro-SD | ⑪ Bouton de reset |
| ④ Boutons de volume | ⑧ Mini-HDMI              |                   |





# L'assistant de démarrage

La première fois que vous allumez votre tablette, l'assistant de démarrage vous permet de paramétrer votre appareil :

- Langue
- Connexion WiFi
- Date & heure
- Votre nom
- Les options du service de localisation
- Applications tierces

## **ASTUCES :**

Pour le paramétrage de votre appareil, nous vous recommandons de vous placer dans la zone WiFi du réseau que vous utilisez régulièrement.







# Se connecter à un réseau WiFi

ATTENTION : assurez-vous d'être dans une zone couverte par un réseau WiFi.

Vous pouvez accéder rapidement aux paramètres WiFi à partir de la barre de statuts.

1. Tirez vers le bas la barre de statuts afin de l'afficher.
2. Une fois affichée, touchez-la à nouveau pour accéder aux réglages rapides.
3. Sélectionnez l'icône WiFi  pour activer la connexion .
4. Sélectionnez "WiFi" en bas de l'icône WiFi.
5. Sélectionnez le nom du réseau auquel vous voulez vous connecter. Les réseaux privés sont affichés avec un cadenas.

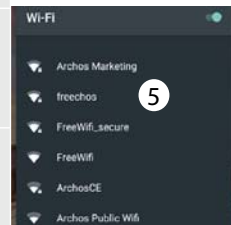
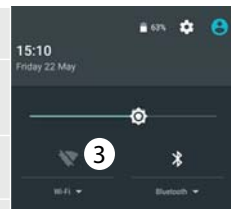





## ASTUCES :

- Lorsque vous saisissez un mot de passe, nous vous recommandons de cocher «Afficher mot de passe» afin de voir les caractères que vous saisissez. Pour obtenir le mot de passe ou les paramètres du réseau WiFi, contactez le fournisseur d'accès à Internet. Si votre WiFi est activé et que vous êtes à portée d'un réseau auquel vous vous êtes déjà connecté, votre tablette tente d'établir automatiquement une connexion.
- Pour maintenir votre connexion WiFi active lorsque la tablette est en veille, sélectionnez l'icône de Menu dans l'écran "WiFi", puis sélectionnez Options avancées > WiFi actif en veille > Toujours.





## Se connecter au WiFi via le procédé WPS

1. Tirez vers le bas la barre de statuts afin de l'afficher.
2. Une fois affichée, touchez-la à nouveau pour accéder aux réglages rapides.
3. Sélectionnez l'icône WiFi  pour activer la connexion .
4. Sélectionnez "WiFi" en bas de l'icône WiFi.
5. Sélectionnez le bouton de Menu , puis Options avancées.
6. Sélectionnez le bouton WPS Push.
7. Appuyez sur le bouton WPS de votre routeur. Il peut porter le nom "WPS" ou le symbole : 

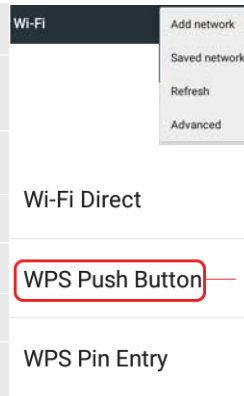



# L'interface Android™

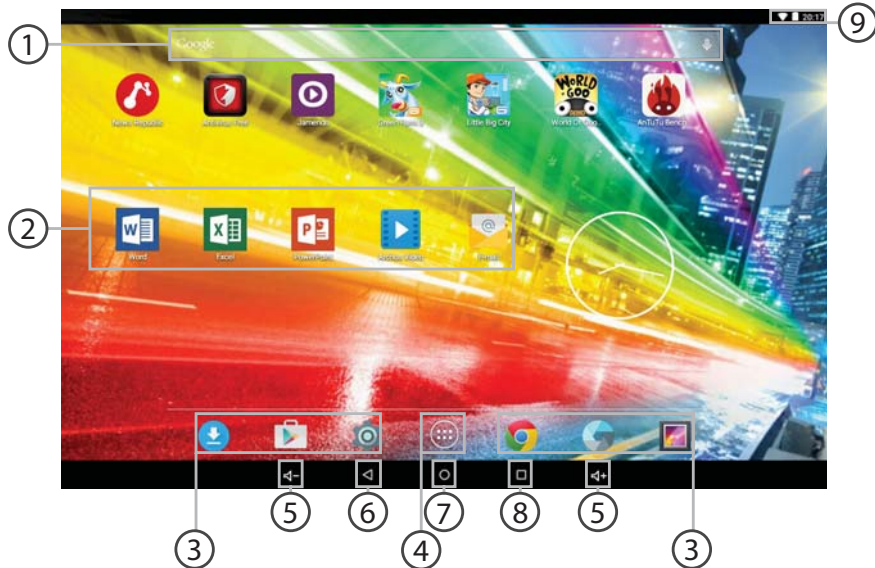





- ① **Google™ Search**  
> Sélectionnez “Google” pour saisir votre recherche ou l’icône microphone pour l’énoncer.
- ② **Raccourcis d’applications Android™**  
> Sélectionnez une application pour l’ouvrir.
- ③ **Raccourcis permanents d’applications Android™**
- ④ **“ Toutes les Applications ”**  
> Sélectionnez pour afficher toutes les applications et les widgets installés sur votre ARCHOS. Vous retrouverez toutes vos applications téléchargées.
- ⑤ **Volume +/-**
- ⑥ **“Retour”**
- ⑦ **“Accueil”**
- ⑧ **“Applications récentes”**
- ⑨ **Barre de statuts**  
> Elle affiche les notifications et permet l’accès aux réglages rapides.



# L'interface Android™

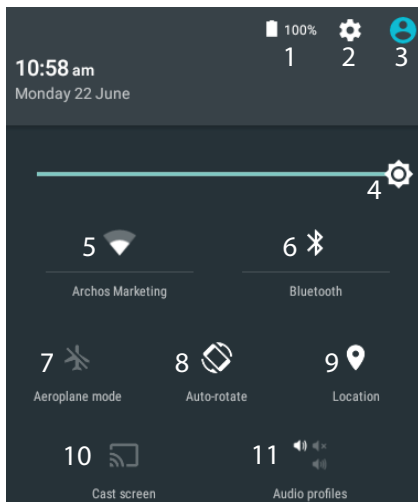

\*Cette option permet à différents utilisateurs d'une même tablette d'avoir chacun son propre espace personnalisable. Ajoutez des utilisateurs à partir de Paramètres > Appareil.

## Les Réglages rapides

- 1 Pourcentage de batterie restant
- 2 Pour accéder à tous vos paramètres.
- 3 Affiche l'icône de l'utilisateur actuel\*.
- 4 Pour ajuster la luminosité de l'écran.
- 5 Pour activer/désactiver votre connexion WiFi.
- 6 Pour activer/désactiver votre connexion Bluetooth.
- 7 Pour activer/désactiver toutes les connexions sans fil. Par exemple, pour prendre l'avion.
- 8 Pour activer/désactiver l'orientation automatique de l'écran dès que vous tournez votre tablette.
- 9 Les options du service de localisation
- 10 Pour afficher l'écran de votre appareil sur votre télé afin de profiter d'un affichage grand écran.
- 11 Pour sélectionner un type de notification



## Les Applications récentes

L'application affiche une liste de vignettes des applications utilisées récemment.

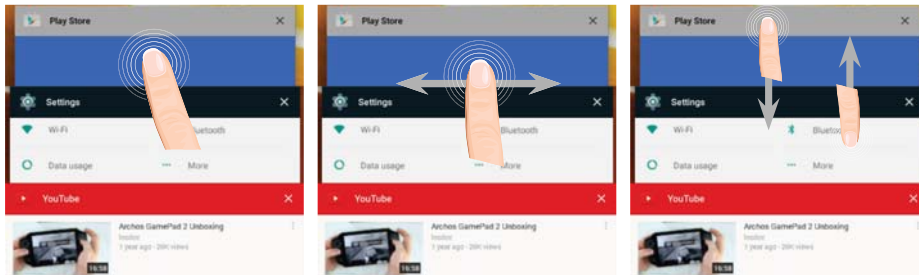

**Pour afficher une application,** sélectionnez-la.

**Pour fermer une application,** faites-la glisser vers le haut ou vers le bas.

**Pour afficher les applications récentes,** faites-les défiler vers le bas ou vers le haut.





# ARCHOS Fusion Storage

## Paramétrage du ARCHOS Fusion Storage

1. Insérez une carte micro-SD dans l'emplacement correspondant. Assurez-vous d'insérer la carte dans la bonne direction.

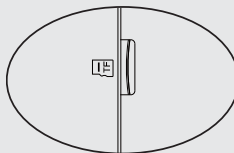

Votre appareil détecte automatiquement votre carte micro-SD et vous propose de fusionner la mémoire interne et la carte micro-SD.

2. Sélectionnez "OK".

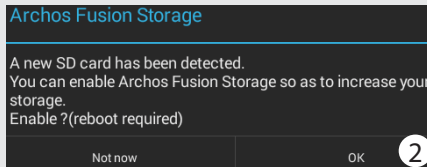

3. Sélectionnez "OK" dans la nouvelle fenêtre pour confirmer votre choix.

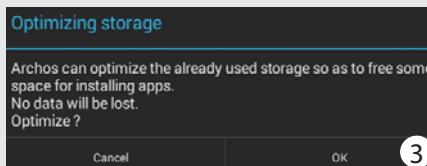



L'appareil redémarre.

- Lorsque l'appareil redémarre, l'ARCHOS Fusion Storage est activé.
- Dans la barre de statuts, une notification s'affiche.
- Sélectionnez l'application Paramètres, puis ARCHOS Fusion Storage. Le stockage fusionné s'affiche.

### Désactivation de l'ARCHOS Fusion Storage

1. Sélectionnez l'application Paramètres.
2. Dans l'application Paramètres, sélectionnez ARCHOS Fusion Storage.
3. Lorsque l'ARCHOS Fusion Storage est activé, sélectionnez "Désactiver ARCHOS Fusion Storage" puis confirmez.

Votre appareil redémarre pour appliquer les changements.

#### OPTIONS

Disable Archos Fusion Storage  
Get back to the initial configuration

#### **Astuce :**

Nous vous recommandons d'éteindre votre appareil avant d'insérer la carte micro-SD.





# Se familiariser avec Android™



## Déplacer une icône de l'écran d'accueil :

Maintenez votre doigt appuyé sur l'icône jusqu'à ce que s'affichent les lignes de positionnement, puis faites-la glisser vers l'emplacement souhaité, et relâchez.

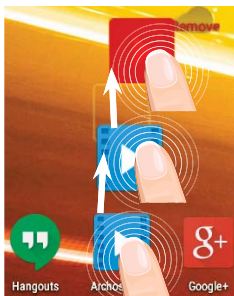

## Supprimer une icône de l'écran d'accueil :

Maintenez votre doigt appuyé sur l'icône, puis faites-la glisser vers le haut de l'écran, et déposez-la sur l'icône "Supprimer".



## Désinstaller une application :

A partir de l'écran "Toutes les applications", maintenez votre doigt appuyé sur l'icône, puis faites-la glisser vers le haut de l'écran et déposez-la sur l'icône "Désinstaller".



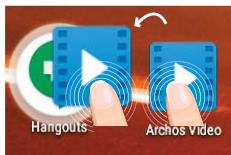

### Créer des dossiers d'applications :

A partir d'un écran d'accueil, déposez une icône sur une autre pour les rassembler.



### Changer le fond d'écran :

Maintenez votre doigt appuyé sur un emplacement vide de l'écran, puis choisissez parmi la liste d'options : Fonds d'écran.



### Widgets :

Maintenez votre doigt appuyé sur un emplacement vide de l'écran, puis choisissez parmi la liste d'options : Widgets.





# Dépannage

## **Si votre appareil ne répond pas :**

Appuyez sur le bouton ON/OFF pendant 10 secondes.

## **Si votre appareil ne s'allume pas :**

1. Chargez votre appareil.
2. Appuyez sur le bouton ON/OFF pendant 10 secondes.

## **Si vous voulez prolonger l'autonomie de la batterie :**

Diminuez la luminosité de l'écran et désactivez les connexions sans fil si elles sont inutilisées.

## **Si votre appareil fonctionne au ralenti :**

Fermez les applications qui ne sont pas en cours d'utilisation.

## **Si votre réception WiFi est trop faible :**

Assurez-vous de ne pas être trop loin de la borne WiFi.

Mettez à jour le logiciel du produit: <http://www.archos.com/support>.

Réinitialisez vos paramètres de connexion WiFi.

Contactez le fournisseur d'accès.







# Inhaltsverzeichnis

Beschreibung des Packungsinhalts.....	34
Erste Schritte.....	35
Beschreibung des Geräts.....	36
Installationsassistent.....	37
WiFi (WLAN)-Verbindung.....	38
Die Android™ Benutzeroberfläche.....	40
ARCHOS Fusion Storage.....	44
Android™ kennenlernen.....	46
Fehlersuche.....	48

Weitere Informationen finden Sie unter den FAQs unter [www.archos.com](http://www.archos.com). Bitte lesen Sie diese Informationen sorgfältig, bevor Sie die Rückgabe eines Produkts erwägen. Möglicherweise lässt sich Ihr Problem leicht lösen. Da unsere Produkte kontinuierlich aktualisiert und weiterentwickelt werden, kann die Software Ihres Geräts in Erscheinung und Funktionalität geringfügige Abweichungen zu den Darstellungen in dieser Kurzbedienungsanleitung aufweisen.

Konsultieren Sie die Konformitätserklärung auf [http://www.archos.com/products/declaration\\_conformity.html](http://www.archos.com/products/declaration_conformity.html)





# Beschreibung des Packungsinhalts



ARCHOS 101c Platinum



Benutzerhandbuch



Garantie, Impressum und  
Sicherheitshinweise



USB Kabel

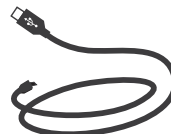

Ladegerät





# Erste Schritte

## Aufladen des Akkus

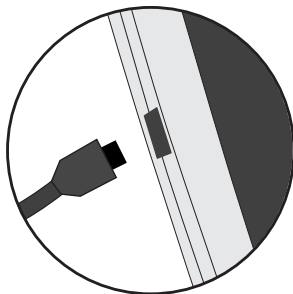

1. Laden Sie das Gerät auf, indem Sie das Netzkabel an den ARCHOS-anschluss anschließen. Das ARCHOS-Gerät beginnt zu laden.
2. Drücken Sie die Ein / Aus-Taste, um das Gerät einzuschalten.

- Sie können den ARCHOS auch während des Ladens verwenden.

- Laden Sie Ihr Gerät vor der ersten Nutzung einmal vollständig auf.

- Verwenden Sie nur das mitgelieferte Netzgerät.

**Hat sich Ihr Gerät komplett entladen, muss es für mindestens 10 Minuten geladen werden, bevor das Batterieladesymbol angezeigt werden kann.**

### TIPP:

Um unseren Service voll nutzen zu können, empfehlen wir Ihnen, Ihr Produkt zu registrieren. Für die Registrierung mittels Computer gehen Sie zu [www.archos.com/register](http://www.archos.com/register).





# Beschreibung des ARCHOS

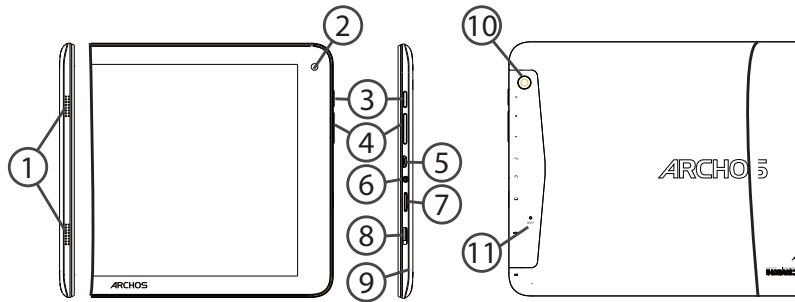

① Lautsprecher

② Webcam

③ EIN/AUS-Taste

④ Lautstärketasten

⑤ Micro USB Port

⑥ Kopfhöreranschluss

⑦ microSD Karten Steckplatz

⑧ Mini-HDMI

⑨ Eingebautes Mikro

⑩ Kamera

⑪ Hardware-Reset





# Installationsassistent

Wenn Sie Ihren ARCHOS das erste Mal in Betrieb nehmen, leitet Sie der Installationsassistent durch einige Bildschirme, um Ihnen dabei zu helfen, die grundlegenden Einstellungen vorzunehmen :

- Sprache
- WLAN Verbindung
- Datum & Uhrzeit
- Ihre Name
- Standortdienst
- Anwendungen von Drittanbietern

**TIPP:**

Definieren Sie die Parameter des Gerätes für das WiFi (WLAN) Netzwerk, das Sie regelmäßig verwenden.







# WiFi (WLAN) Verbindung

**ACHTUNG:** Überprüfen Sie, ob Sie sich in einer WLAN-Zone befinden. Über die Statusleiste kann schnell auf die WLAN-Einstellungen zugegriffen werden.

1. Die Statusleiste berühren und nach unten ziehen, um diese anzuzeigen.

2. Die Leiste erneut berühren, um die Schnelleinstellungen anzuzeigen.

3. Wählen Sie das WLAN-Symbol  zur Aktivierung der WLAN-Verbindung .

4. Wählen Sie "WLAN" unter dem WLAN-Symbol.

5. Tippen Sie auf den Namen des Netzwerks, mit dem eine Verbindung hergestellt werden soll.

Private Netzwerke werden mit einem Schlosssymbol angezeigt und hier muss das Passwort eingegeben werden.

## TIPPS:

- Bei Eingabe eines WLAN-Passworts empfehlen wir Ihnen, «Show Password» (Passwort anzeigen) zu wählen. Das korrekte WLAN-Passwort (oder die Einstellungen) für das Netzwerk erhalten Sie von dem betreffenden WLAN-Provider. Wenn WLAN aktiviert ist und Sie sich in Reichweite eines Netzwerks befinden, mit dem Sie zuvor bereits verbunden waren, versucht der ARCHOS automatisch, eine Verbindung mit diesem Netzwerk herzustellen.
- Um die WLAN-Verbindung zu halten, während sich das Gerät im Standby-Modus befindet, wählen Sie das Menüsymbol auf der Seite "WLAN". Wählen Sie Erweitert>WLAN im Standby-Modus aktiviert lassen>Immer.

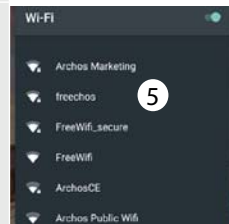
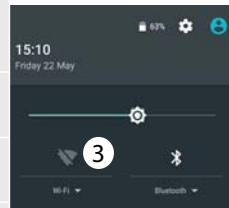





## Verbindung zum WLAN per WPS

1. Die Statusleiste berühren und nach unten ziehen, um diese anzuzeigen.

2. Die Leiste erneut berühren, um die Schnelleinstellungen anzuzeigen.

3. Wählen Sie das WLAN-Symbol  zur Aktivierung der WLAN-Verbindung .

4. Wählen Sie "WLAN" unter dem WLAN-Symbol.

5. Wählen Sie die Menü-Taste  und dann "Erweitert".

6. Wählen Sie WPS Push Button.

7. Drücken Sie die WPS-Taste auf Ihrem Router. Diese nennt sich "WPS" oder enthält ein Symbol: 

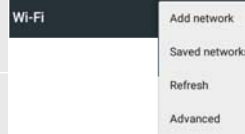

Wi-Fi Direct

WPS Push Button

WPS Pin Entry





# Die Android™ Benutzeroberfläche

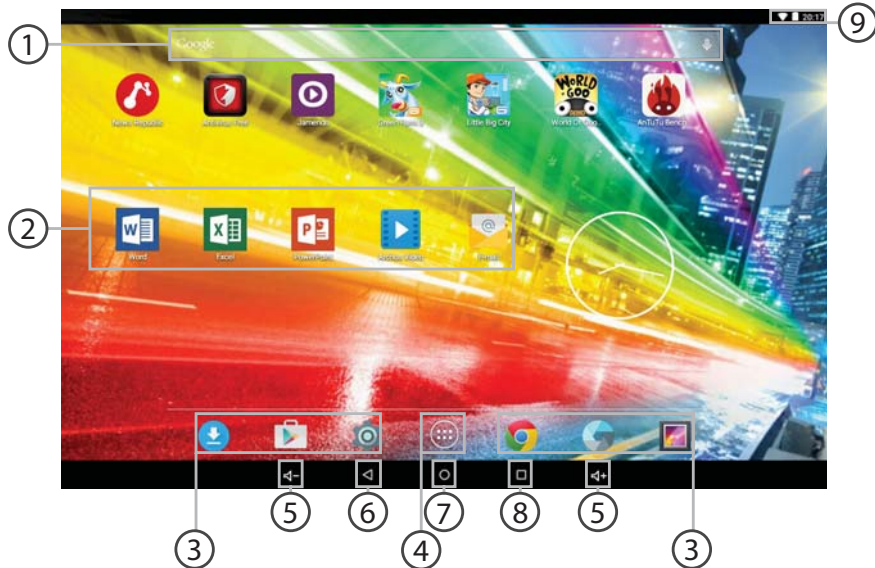





- ① **Google™ Suche**  
> Suchbegriff eintippen oder Spracheingabe verwenden.
- ② **Android™ Apps**  
> Die Aktivierung einer App erfolgt durch Berühren.
- ③ **Permanenten Android™ Apps-Verknüpfungen**
- ④ **“Alle Apps”**  
> Berühren Sie dieses Symbol, um alle auf Ihrem ARCHOS installierten Apps und Widgets anzuzeigen. Alle heruntergeladenen Anwendungen befinden sich hier.
- ⑤ **Lautstärketaten**
- ⑥ **“Zurück”**
- ⑦ **“Startbildschirm”**
- ⑧ **“Letzte Apps”**
- ⑨ **Statusleiste**  
> Auf der Statusleiste werden Benachrichtigungen und die Systemsymbole angezeigt.



# Die Android™ Benutzeroberfläche

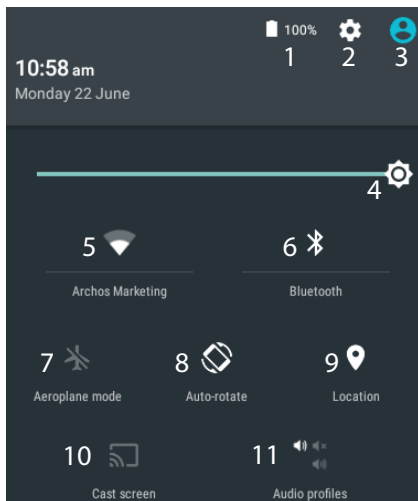

\*Mit dem neuen Multi-User-Support für Tablets besitzt jeder Benutzer seinen eigenen separaten und anpassbaren Bereich auf einem einzelnen Gerät. Benutzer können unter Settings > Device [Einstellungen > Gerät] hinzugefügt werden.

## Schnelleinstellungen

- 1 Akkurestlaufzeit in Prozent
- 2 Zugriff auf alle Einstellungen.
- 3 Aktueller Benutzer\*
- 4 Einstellung der Bildschirmhelligkeit.
- 5 Ein- und Ausschalten der WLAN-Verbindung.
- 6 Ein- und Ausschalten der Bluetooth-Verbindung.
- 7 Beendet alle WLAN-Verbindungen, nützlich für Flugreisen.
- 8 Ermöglicht die Aktivierung und Deaktivierung der automatischen Display-Drehung.
- 9 Aktivieren / Deaktivieren Sie Ihre GPS-Verbindung.
- 10 Für die Wiedergabe Ihres Android-Geräts auf dem Fernseher, um so Ihre großartigen Inhalte exakt genauso wie auf Ihrem Mobilgerät, anzuzeigen.
- 11 Auswahl eines Benachrichtigungstyps



## Letzte Apps

Öffnet eine Liste mit Mini-Abbildungen der kürzlich verwendeten Apps:

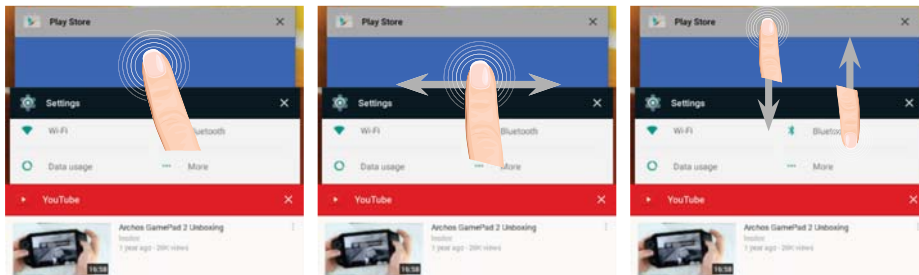

**Tippen:** öffnen einer Anwendung.

**Nach rechts oder links wischen:** Eine Anwendung schließen.

**Auf- und abwärts scrollen:** Anzeige der zuletzt verwendeten Apps





# ARCHOS Fusion Storage

## Fusion Storage einrichten

1. Stecken Sie eine micro-SD-Karte in den micro-SD-Kartensteckplatz des Geräts ein.  
Achten Sie darauf, die Karte in die korrekte Richtung einzustecken.

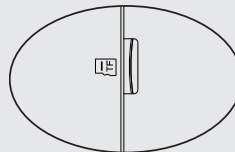

Die micro-SD-Karte wird von Ihrem Gerät automatisch erkannt und es bietet Ihnen an, den internen Speicher mit der micro-SD-Karte zu kombinieren.  
2. Wählen Sie „OK“.

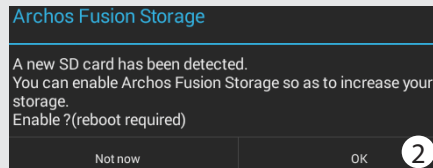

3. Wählen Sie "OK" im Fenster für die Speicheroptimierung, um Ihre Auswahl zu bestätigen.

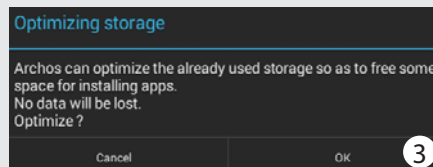



Das Gerät wird neu gestartet.

- Sobald das Gerät neu gestartet wurde, werden Sie darüber informiert, dass ARCHOS Fusion Storage aktiv ist.
- In der Statusleiste wird eine Benachrichtigung angezeigt.
- Wählen Sie die App "Einstellungen" und dann "ARCHOS Fusion Storage". Der kombinierte Speicher wird angezeigt.

### Fusion Storage deaktivieren

1. Wählen Sie die App "Einstellungen".
2. Wählen Sie in der App "Einstellungen" die Option "ARCHOS Fusion Storage".
3. Ist ARCHOS Fusion Storage aktiv, wählen Sie "ARCHOS Fusion Storage deaktivieren" und bestätigen. Ihr Gerät wird jetzt neu gestartet, um die Änderungen zu übernehmen.

#### OPTIONS

Disable Archos Fusion Storage  
Get back to the initial configuration

### Tipp:

Wir empfehlen das Ausschalten des Geräts vor dem Einstecken der micro-SD-Karte.





# Android™ kennenlernen



## Ein Element vom Startbildschirm verschieben:

Zum Verschieben eines Elements vom Startbildschirm den Finger darauf legen und so lange halten, bis die Rasterlinien zur Positionierung erscheinen. Dann an die gewünschte Stelle schieben und loslassen.

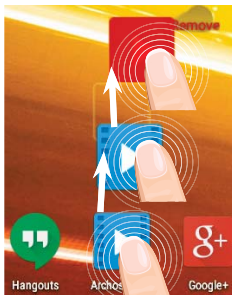

## Ein Element vom Startbildschirm entfernen:

Den Finger auf das Element legen und halten. Den Finger auf dem Bildschirm nach oben bewegen und über dem «Entfernen»-Symbol loslassen.



## Ein Element deinstallieren:

Auf den «Alle Apps»-Bildschirmen das betreffende Element berühren und halten. Den Finger im Bildschirm nach oben bewegen und über dem «Deinstallieren»-Papierkorb loslassen.



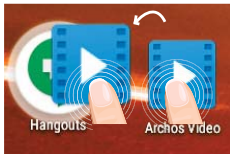

### Anwendungsordner erstellen:

Ziehen Sie auf einem Startbildschirm ein Anwendungssymbol über ein anderes. Die beiden Symbole werden kombiniert.

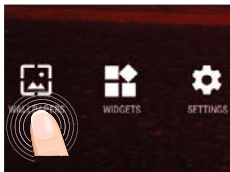

### Hintergrundbild ändern:

Den Finger auf eine freie Stelle des Bildschirms legen und dann aus der Liste auswählen.



### Widgets:

Berühren Sie das «Alle Apps»-Symbol auf dem Startbildschirm. Berühren Sie «Widgets» oben auf dem Bildschirm. Auf dem «Widgets»-Hauptbildschirm können Sie Widgets genau wie Anwendungssymbole auch verschieben.





# Fehlersuche

## **Das Gerät reagiert nicht mehr:**

Halten Sie die EIN/AUS-Taste 10 Sekunden lang gedrückt.

## **Wenn sich das Gerät nicht wieder einschaltet:**

1. Laden Sie das Gerät auf.
2. Halten Sie die EIN/AUS-Taste 10 Sekunden lang gedrückt.

## **Akkulaufzeit verlängern:**

Verringern Sie die Bildschirmhelligkeit und schalten Sie die WiFi(WLAN)-Verbindungen aus, wenn diese nicht verwendet werden.

## **Das Gerät ist zu langsam:**

Schließen Sie alle Anwendungen, die nicht verwendet werden.

## **WiFi(WLAN)-Empfang ist zu schwach:**

Stellen Sie sicher, dass Sie sich in Reichweite eines WiFi(WLAN)-Hotspots befinden.

Aktualisieren Sie die Firmware des Gerätes: <http://www.archos.com/support>.

Setzen Sie die WiFi-Verbindung zurück.

Kontaktieren Sie Ihren WiFi(WLAN)-Provider.







# Índice

Contenido de la caja.....	50
Procedimientos iniciales.....	51
Descripción del ARCHOS.....	52
Asistente de inicio.....	53
Conexión a una red WiFi.....	54
La interfaz Android™.....	56
ARCHOS Fusion Storage.....	60
Para familiarizarse con Android™.....	62
Solución de problemas.....	64

Para obtener más información, consulte la sección de preguntas frecuentes en la dirección [www.archos.com](http://www.archos.com). Asegúrese de leerlos antes de considerar devolver el producto. Puede haber una solución fácil a su problema. Tenga en cuenta que como estamos actualizando y mejorando constantemente nuestros productos, el software de su dispositivo puede variar ligeramente con respecto a lo descrito en esta Guía Rápida.

Consulte la declaración de conformidad en [http://www.archos.com/products/declaration\\_conformity.html](http://www.archos.com/products/declaration_conformity.html)





# Contenido de la caja



ARCHOS 101c Platinum



Guía de usuario



Avisos de garantía, legales y de seguridad



Cable USB



Cargador





# Procedimientos iniciales

## Cargado de la batería

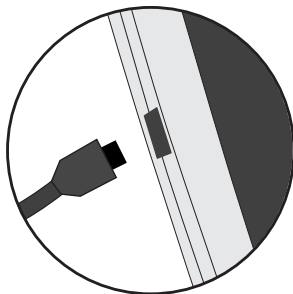

1. Para cargar el dispositivo, conecte el cable de alimentación al Conector de alimentación. El dispositivo ARCHOS iniciará la carga.
2. Pulse el botón de encendido / apagado para encender el producto.

- Puede utilizar el ARCHOS mientras se carga.
- Deje cargar completamente el dispositivo la primera vez que lo utilice.
- Utilice únicamente el cargador suministrado.

**Cuando el dispositivo está completamente descargado, deberá cargarlo durante al menos 10 minutos antes de que aparezca el icono de carga de batería.**

### CONSEJOS:

Para recibir una asistencia más completa, registre su producto.  
Con un ordenador, vaya a [www.archos.com/register](http://www.archos.com/register).





# Descripción del ARCHOS

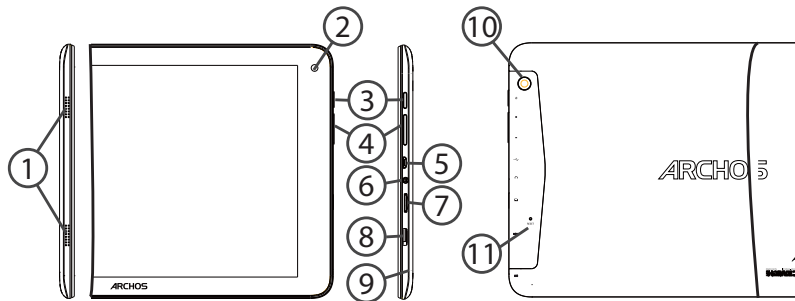

① Altavoces

② Webcam

③ Botón ON/OFF

④ Botones de volumen

⑤ Puerto micro-USB

⑥ Toma de auriculares

⑦ Lector de tarjetas micro-SD

⑧ Mini HDMI

⑨ Micrófono

⑩ Cámara

⑪ Restablecimiento del equipo





# Asistente de inicio

La primera vez que encienda el ARCHOS, el asistente de instalación le ayudará a configurar el dispositivo :

- Idioma
- Conexión WiFi
- Fecha y hora
- Su nombre
- El servicio de ubicación
- Aplicaciones de terceras partes

## **CONSEJOS:**



Definir los parámetros de su dispositivo en el área de la red WiFi que usted será regularmente usando.





# Conexión WiFi

**ADVERTENCIA:** Asegúrese de que se encuentra en una zona con cobertura WiFi. Puede acceder rápidamente a los ajustes WiFi desde la barra de estado.

1. Toque y arrastre hacia abajo la barra de estado para mostrarla.
2. Vuelva a tocar la barra para mostrar los ajustes rápidos.
3. Seleccione el icono WiFi  para activar la conexión WiFi .
4. Seleccione "WiFi" bajo el icono WiFi.

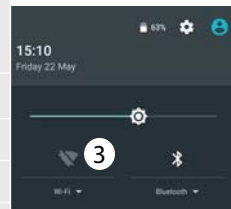

5. Toque el nombre de la red a la que se desee conectar. Las redes privadas aparecen con un icono de candado, lo que significa que deberá introducir una contraseña.



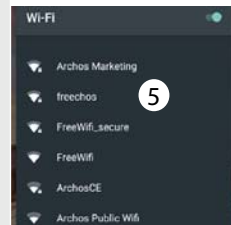

## CONSEJOS:

- Al introducir una contraseña WiFi, se recomienda que seleccione "Mostrar contraseña". Para obtener la contraseña (o los ajustes) WiFi correcta para la red, póngase en contacto con el proveedor de la red WiFi. Si su sistema WiFi se activa y se encuentra dentro del alcance de una red a la que se haya conectado anteriormente, el ARCHOS intentará automáticamente conectarse a ella.
- Para mantener la conexión WiFi activada con el dispositivo en reposo, seleccione el icono Menú en la página "WiFi". Luego, seleccione Advanced > Keep WiFi on during sleep > Always [Avanzado > Mantener WiFi activo durante el periodo de reposo > Siempre].





## Conexión a la WiFi mediante WPS

1. Toque y arrastre hacia abajo la barra de estado para mostrarla.
2. Vuelva a tocar la barra para mostrar los ajustes rápidos.
3. Seleccione el icono WiFi  para activar la conexión WiFi .
4. Seleccione "WiFi" bajo el icono WiFi.
5. Seleccione el botón Menú , y luego Avanzado.
6. Seleccione la opción de configuración mediante botón WPS.
7. Pulse el botón de Configuración protegida WiFi en su router. Puede estar etiquetado como "WPS" y contener un símbolo: 

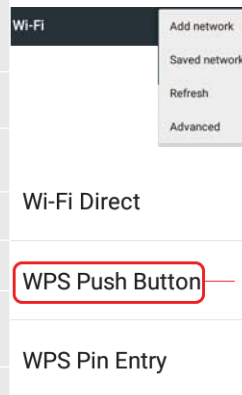



# El Interfaz Android™

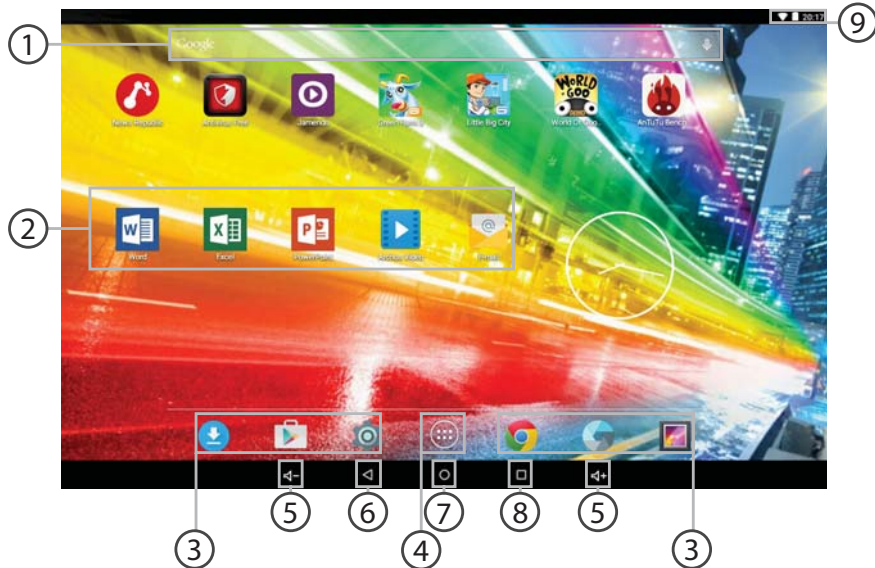





- ① **Google™ Search**  
> Toque para búsqueda de texto o busque por voz .
- ② **Aplicaciones Android™**  
> Toque para iniciar una aplicación.
- ③ **Acceso directo permanente a aplicaciones Android™**
- ④ **"Todas las aplicaciones"**  
> Toque este icono para mostrar todas las aplicaciones y widgets instalados en el ARCHOS. Todas las aplicaciones descargadas se encuentran aquí.
- ⑤ **Botones de volumen**
- ⑥ **"Volver"**
- ⑦ **"Inicio"**
- ⑧ **"Aplicaciones recientes"**
- ⑨ **Barra de estado**  
> Muestra notificaciones y ajustes rápidos.



# El Interfaz Android™

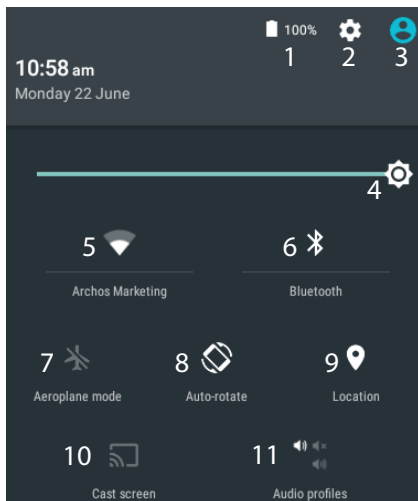

\*El nuevo soporte multiusuario para tabletas permite que distintos usuarios tengan sus propios espacios personalizables e independientes en un único dispositivo. Añada usuarios en Settings > Device [Ajustes > Dispositivo].

## Los ajustes rápidos

- 1 Porcentaje de batería restante
- 2 Para acceder a todos los ajustes.
- 3 Usuario actual\*
- 4 Para ajustar el brillo de la pantalla.
- 5 Para activar/desactivar la conexión WiFi.
- 6 Para activar/desactivar la conexión Bluetooth.
- 7 Para activar/desactivar todas las conexiones inalámbricas, especialmente al volar.
- 8 Para activar/desactivar la orientación automática de la pantalla al girar el ARCHOS.
- 9 El servicio de ubicación
- 10 Para reproducir la pantalla del dispositivo Android en un televisor y poder disfrutar de su contenido tal y como aparece en el dispositivo móvil.
- 11 Para seleccionar un tipo de notificación



## Aplicaciones recientes

Abre una lista de imágenes en miniatura de las aplicaciones con las que haya trabajado recientemente:

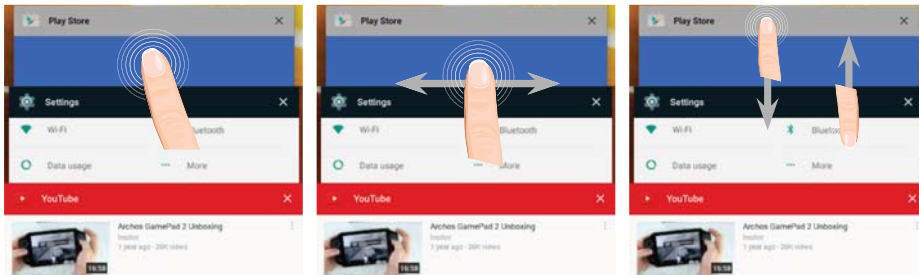

**Tocar:** para abrir una aplicación.

**Mover el dedo derecho o izquierdo:** para cerrar una aplicación.

**Arrastrar con el dedo arriba/abajo:** para ver otras aplicaciones recientes





# ARCHOS Fusion Storage

## Configuración de fusion storage

1. Inserte una tarjeta micro SD en la ranura de tarjetas micro SD del dispositivo.  
Asegúrese de insertarla en la dirección correcta.

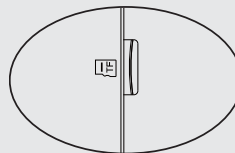

El dispositivo detectará automáticamente la tarjeta micro SD y le propondrá fusionar el almacenamiento interno con el de la tarjeta micro SD.  
2. Haga clic en "OK" (Aceptar).

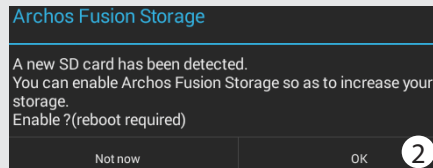

3. Seleccione "OK" en la ventana de optimización de almacenamiento para confirmar su elección.

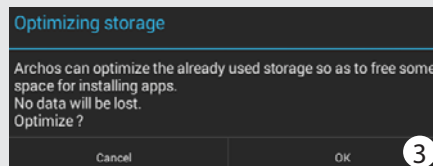



El dispositivo se reiniciará.

- Una vez reiniciado, el dispositivo le indicará que ARCHOS Fusion storage está activado.
- En la barra de estado, aparecerá una notificación.
- Seleccione la aplicación Ajustes, y luego ARCHOS Fusion Storage. Aparecerá entonces el almacenamiento fusionado.

## Desactivación de Fusion Storage

1. Seleccione la aplicación Ajustes.
2. En la aplicación Ajustes, seleccione ARCHOS Fusion Storage.
3. Si la aplicación está activa, seleccione "Disable ARCHOS Fusion Storage" para desactivarla y confirme. El dispositivo se reiniciará para hacer efectivos los cambios.

### OPTIONS

Disable Archos Fusion Storage  
Get back to the initial configuration

## Consejo:

Recomendamos apagar el dispositivo antes de insertar la tarjeta micro SD.





# Para familiarizarse con Android™



## Desplazamiento de un elemento de la pantalla de inicio:

Mantenga el dedo sobre él hasta que aparezcan líneas de cuadrícula de posición; a continuación, deslícelo hasta la ubicación deseada y suelte el dedo.

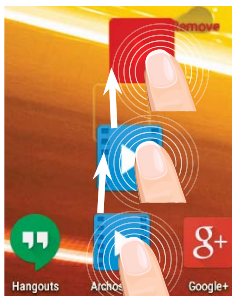

## Eliminación de un elemento de la pantalla de inicio:

Mantenga el dedo sobre él, deslice el dedo hacia la parte superior de la pantalla y déjelo caer sobre el icono "Eliminar."



## Desinstalación de un elemento:

En las pantallas Todas las aplicaciones, mantenga el dedo sobre él, deslice el dedo hacia la parte superior de la pantalla y déjelo caer sobre la papelera "Desinstalar".



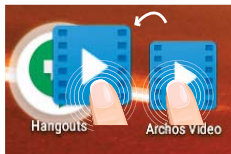

### Creación de carpetas de aplicaciones:

Deje caer un icono de aplicación sobre otro en una pantalla de inicio y los dos iconos se combinarán.



### Cambio del fondo:

Mantenga el dedo en la pantalla en una ubicación vacía y, a continuación, elija en la lista.



### Widgets:

Mantenga el dedo en la pantalla en una ubicación vacía y, a continuación, elija en la lista: "Widgets".





# Solución de problemas

---

## **Si el dispositivo se bloquea:**

Pulse el botón ON/OFF durante 10 segundos.

## **Si el dispositivo no se enciende:**

1. Cargue el dispositivo.
2. Pulse el botón ON/OFF durante 10 segundos.

## **Si desea aumentar la duración de la batería:**

Disminuya el brillo de la pantalla y desactive las conexiones inalámbricas si no las utiliza.

## **Si el dispositivo funciona con demasiada lentitud:**

Cierre todas las aplicaciones que no esté utilizando.

## **Si la recepción WiFi es demasiado baja:**

Asegúrese de que no se encuentra lejos de la zona activa WiFi.

Actualizar el firmware del dispositivo: <http://www.archos.com/support>.

Restablecer la configuración de su conexión.

Póngase en contacto con el proveedor de la conexión WiFi.







# Sommario

Contenuto della confezione.....	66
Avvio.....	67
Descrizione del ARCHOS.....	68
Installazione guidata.....	69
Connessione a una rete WiFi .....	70
L'interfaccia di Android™.....	72
ARCHOS Fusion Storage.....	76
Conoscere Android™.....	78
Soluzione dei problemi.....	80

Per ulteriori informazioni, consultare le FAQ su [www.archos.com](http://www.archos.com). Accertarsi di aver letto questo materiale prima di considerare l'eventuale restituzione del prodotto. Il problema riscontrato potrebbe non essere davvero un problema! Poiché i nostri prodotti vengono continuamente aggiornati e migliorati, è possibile che il software del dispositivo si presenti in modo leggermente diverso o con funzioni modificate rispetto a quanto presentato nella presente Guida rapida.

Consultare la dichiarazione di conformità su [http://www.archos.com/products/declaration\\_conformity.html](http://www.archos.com/products/declaration_conformity.html)





# Contenuto della confezione



ARCHOS 101c Platinum



Guida dell'utente



Garanzia, note legali e sulla sicurezza



Cavo USB

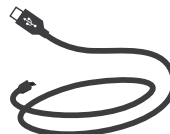

Caricatore





# Avvio

## Caricamento della batteria

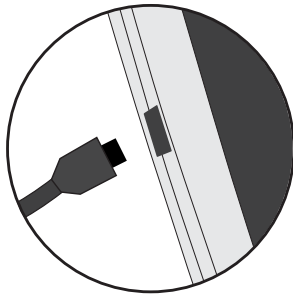

1. Caricare il dispositivo collegando il cavo di alimentazione nella connettore di alimentazione. Il dispositivo ARCHOS inizierà a ricaricarsi.
2. Premere il pulsante On / Off per accendere il prodotto.

- Durante il caricamento è possibile usare ARCHOS.
- Caricare completamente il dispositivo al primo utilizzo.
- Utilizzare solo il caricabatteria incluso.

**Quando il tuo dispositivo è completamente scarico, devi caricarlo per almeno 10 minuti prima che possa essere visualizzata l'icona di ricarica della batteria.**

### CONSIGLI:

Per ricevere un'assistenza più completa, registrare il prodotto.  
Con un computer, andare su [www.archos.com/register](http://www.archos.com/register).





# Descrizione del ARCHOS

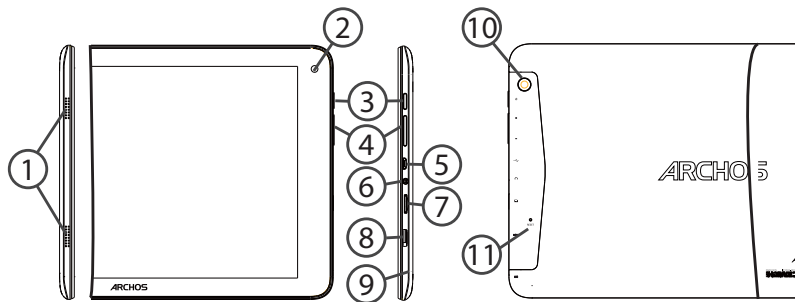

- |                   |                              |                         |
|-------------------|------------------------------|-------------------------|
| ① Altoparlante    | ⑤ Pulsante volume            | ⑨ Microfono incorporato |
| ② Webcam          | ⑥ Spinotto cuffie            | ⑩ Camera                |
| ③ Pulsanti ON/OFF | ⑦ Lettore di schede micro SD | ⑪ Ripristino hardware   |
| ④ Porta micro-USB | ⑧ Mini HDMI                  |                         |





# Installazione guidata

La prima volta che si avvia ARCHOS, il wizard di installazione aiuterà ad installare il dispositivo :

- Lingua
- Connessione WiFi
- Data e ora
- Il tuo nome
- Il servizio di localizzazione
- Applicazioni di altri produttori



## **CONSIGLI:**

Definire i parametri del dispositivo nella zona della rete WiFi si utilizzano regolarmente.



# Connessione a una rete wireless

**AVVERTENZA:** assicurarsi di essere in una zona Wi-Fi. È possibile accedere rapidamente alle impostazioni Wi-Fi dalla barra di stato.

1. Toccare e tirare verso il basso la barra di stato per visualizzarla.
2. Toccare di nuovo la barra per visualizzare le impostazioni rapide.
3. Selezionare l'icona del Wi-Fi  per attivare la connessione Wi-Fi .
4. Selezionare "Wi-Fi" sotto l'icona del Wi-Fi.

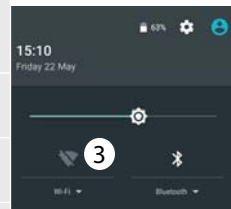

5. Toccare il nome della rete a cui l'utente desidera connettersi. Le reti private vengono mostrate con un'icona di blocco e richiedono l'inserimento della password.

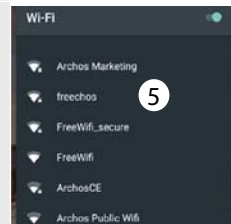





## CONSIGLI:

- Quando si inserisce una password WiFi, si consiglia di selezionare «Visualizza password». Per ottenere la password (impostazioni) WiFi corretta per la rete, contattare il fornitore della rete WiFi. Se la rete WiFi è attiva e ci si trova all'interno di una rete precedentemente utilizzata, il vostro ARCHOS automaticamente tenterà di collegarsi nuovamente alla stessa rete.
- Per mantenere attiva (ON) la connessione WiFi quando il dispositivo è in modalità sleep, seleziona l'icona Menu nella pagina "WiFi". Poi seleziona Advanced > Keep WiFi on during sleep > Always [Avanzate > Mantieni attivo il WiFi in modalità sleep > Sempre].





## Connessione al Wi-Fi con WPS

1. Toccare e tirare verso il basso la barra di stato per visualizzarla.
2. Toccare di nuovo la barra per visualizzare le impostazioni rapide.
3. Selezionare l'icona del Wi-Fi  per attivare la connessione Wi-Fi .
4. Selezionare "Wi-Fi" sotto l'icona del Wi-Fi.
5. Selezionare il pulsante Menu , quindi Advanced [Avanzate].
6. Selezionare WPS Push Button.
7. Premere il pulsante WiFi Protected Setup [Impostazione protetta Wi-Fi] sul router. Potrebbe riportare il nome "WPS" o il simbolo .

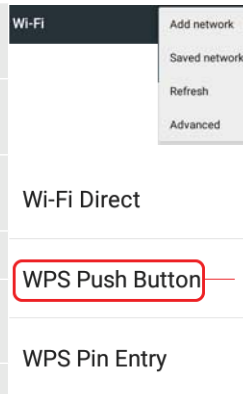



# Interfaccia Android™







- ① **Google™ Search**  
> Selezionare la ricerca per testo o per voce.
- ② **Applicazioni Android™**  
> Selezionare per avviare un'applicazione.
- ③ **Icone permanenti di accesso rapido alle app Android™**
- ④ **“Tutte le applicazioni”**  
> Selezionare questa icona per visualizzare tutte le applicazioni e i widget si accenderanno sul vostro ARCHOS. Tutte le applicazioni scaricate sono qui.
- ⑤ **Volume +/-**
- ⑥ **“Indietro”**
- ⑦ **“Home”**
- ⑧ **“Applicazioni recenti”**
- ⑨ **Barra di stato**  
> Che visualizza le notifiche e le impostazioni rapide.





# Interfaccia Android™

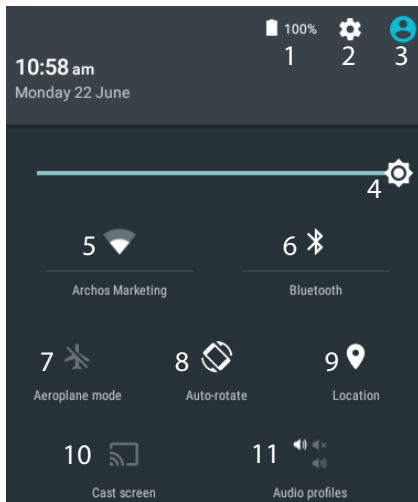

Il nuovo supporto multi-utente per i tablet permette a utenti diversi di avere ciascuno il proprio spazio distinto e personalizzabile su un singolo dispositivo. Puoi aggiungere utenti in Settings > Device [Impostazioni > Dispositivo].

## Impostazioni rapide

- 1 Percentuale di batteria rimasta
- 2 Per accedere a tutte le impostazioni.
- 3 Utente corrente\*
- 4 Per regolare la luminosità dello schermo.
- 5 Per attivare/disattivare la connessione WiFi.
- 6 Per attivare/disattivare la connessione Bluetooth.
- 7 Per attivare/disattivare tutte le connessioni wireless, specialmente in volo.
- 8 Per attivare/disattivare l'orientamento automatico dello schermo mentre si ruota ARCHOS .
- 9 Il servizio di localizzazione
- 10 Per visualizzare sul TV lo schermo del dispositivo Android e godere di tutti i contenuti proprio come vengono visualizzati sul dispositivo mobile.
- 11 Per selezionare un tipo di notifica.





## Applicazioni recenti

Aprire un elenco di immagini in miniatura delle applicazioni su cui si è recentemente lavorato:

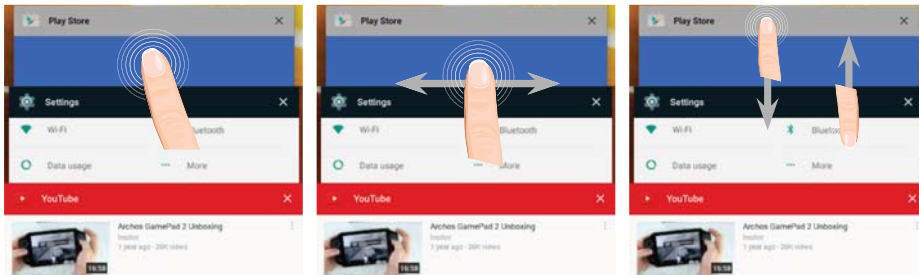

**Tocca:** per aprire una app.

**Scorrere il dito verso sinistra o destra:** chiudi un'app.

**Scorri verso l'alto o verso il basso:** per vedere altre app recenti





# ARCHOS Fusion Storage

## Configurazione di Fusion Storage

1. Inserire una scheda microSD nell'apposito slot del dispositivo. Assicurarsi di inserire la scheda nella direzione corretta.

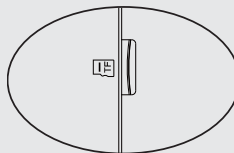

Il dispositivo rileverà automaticamente la scheda microSD e offrirà la possibilità di unire la memoria interna con quella della scheda microSD.

2. Selezionare "OK".

### Archos Fusion Storage

A new SD card has been detected.  
You can enable Archos Fusion Storage so as to increase your storage.  
Enable?(reboot required)

Not now

OK

2

3. Nella finestra Optimizing storage (Ottimizzazione memoria), selezionare "OK" per confermare la scelta.

### Optimizing storage

Archos can optimize the already used storage so as to free some space for installing apps.  
No data will be lost.  
Optimize?

Cancel

OK

3





Il dispositivo si riavvia.

- Dopodiché, l'utente viene informato che ARCHOS Fusion Storage è attivo.
- Nella barra di stato viene visualizzata una notifica.
- Selezionare le impostazioni dell'app e poi ARCHOS Fusion Storage. Viene visualizzata la memoria unita.

## Disattivazione di Fusion Storage

1. Selezionare le impostazioni dell'app.
2. Nelle impostazioni, selezionare ARCHOS Fusion Storage.
3. Quando ARCHOS Fusion Storage è attivo, selezionare "Disable ARCHOS Fusion Storage" (Disattiva ARCHOS Fusion Storage) e confermare.

Il dispositivo si riavvia per applicare le modifiche.

### OPTIONS

Disable Archos Fusion Storage  
Get back to the initial configuration

## Suggerimento:

Prima di inserire la scheda micro-SD, si consiglia di spegnere il dispositivo.





# Conoscere Android™



## **Spostare una voce della schermata iniziale:**

Selezionare e tenere il dito su di essa fino a quando si visualizzano le linee della griglia di posizionamento, quindi scorrere nella posizione desiderata e togliere il dito.

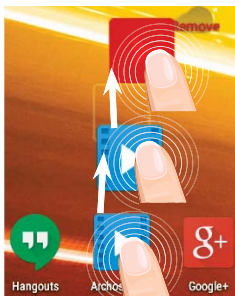

## **Rimuovere una voce della schermata iniziale:**

Selezionare e tenerla, scorrere il dito verso la parte superiore dello schermo e lasciare sull'icona "Rimuovi".

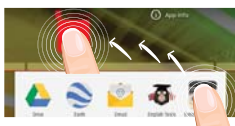

## **Disinstallare una voce:**

Dalle schermate Tutte le applicazioni, selezionare e tenere, scorrere il dito verso la parte superiore dello schermo e lasciare su "Cestino disinstalla".



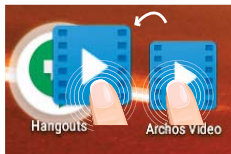

### **Creare cartelle di applicazioni:**

Lasciare un'icona di applicazione su un'altra icona della schermata iniziale e le due icone si combineranno.



### **Modificare lo sfondo:**

Tenere il dito sulla schermata su una posizione vuota, quindi selezionare dall'elenco.



### **Widget:**

Tenere il dito sulla schermata su una posizione vuota, quindi selezionare dall'elenco : "Widget".





# Soluzione dei problemi

---

## **Nel caso in cui il dispositivo sembri bloccato:**

Premere il pulsante ON/OFF per 10 secondi.

## **Nel caso in cui il dispositivo non si accenda:**

1. Caricare il dispositivo.
2. Premere il pulsante ON/OFF per 10 secondi.

## **Se si desidera estendere la vita della batteria:**

Diminuire la luminosità dello schermo e spegnere le connessioni wireless non in uso.

## **Se il dispositivo funziona troppo lentamente:**

Chiudere tutte le applicazioni non attualmente in uso.

## **Se la ricezione WiFi è troppo lenta:**

Accertarsi di non essere troppo lontani dal punto WiFi.

Aggiornare il firmware del dispositivo: <http://www.archos.com/support>.

Ripristinare le impostazioni di connessione.

Contattare il fornitore della connessione WiFi.







# Inhoudsopgave

Wat zit er in de doos?.....	82
Aan de slag.....	83
Beschrijving ARCHOS.....	84
Installatiewizard.....	85
WiFi-netwerkverbinding.....	86
De Android™-Interface.....	88
ARCHOS Fusion Storage.....	92
Vertrouwd raken met Android™.....	94
Problemen oplossen.....	96

Raadpleeg voor meer informatie de veelgestelde vragen (FAQ's) op [www.archos.com](http://www.archos.com). Zorg ervoor dat u ze leest alvorens te overwegen het product te retourneren. Uw probleem kan wel eens een probleempje blijken. Omdat we onze producten voortdurend aanpassen en verbeteren, kan de software van uw apparaat er een beetje anders uitzien of een licht gewijzigde functionaliteit hebben dan voorgesteld in deze Snelstartgids.

Raadpleeg de verklaring van overeenstemming op [http://www.archos.com/products/declaration\\_conformity.html](http://www.archos.com/products/declaration_conformity.html)





# Wat zit er in de doos?



ARCHOS 101c Platinum



Gebruikershandleiding



Garantie, wettelijke mededelingen  
en veiligheidsvoorschriften



USB-kabel

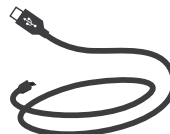

Lader





# Aan de slag

## De batterijen laden

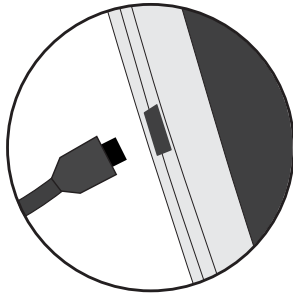

1. Laad uw apparaat op door de stekker van uw voedingskabel in de stroomaansluiting te steken. Het ARCHOS-apparaat begint op te laden.
2. Druk op de aan / uit-knop om het apparaat uit.

- U kunt uw ARCHOS gebruiken terwijl hij wordt opgeladen.
- Laad het apparaat de eerste keer helemaal op.
- Gebruik uitsluitend de meegeleverde oplader.

**Als u uw apparaat gaat opladen met een lege batterij, dan duurt het ten minste 10 minuten voordat het batterijpictogram wordt weergegeven.**

### TIPS:

Registreer uw product om de volledige service te ontvangen.  
Als u een computer hebt, ga dan naar [www.archos.com/register](http://www.archos.com/register).





# Beschrijving ARCHOS

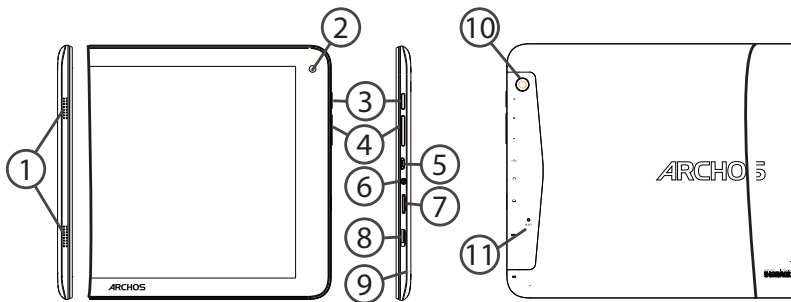

- |                 |                            |                        |
|-----------------|----------------------------|------------------------|
| ① Luidsprekers  | ⑤ Micro USB-poort          | ⑨ Ingebouwde microfoon |
| ② Webcam        | ⑥ Hoofdtelefoonaansluiting | ⑩ Camera               |
| ③ AAN/UIT-knop  | ⑦ Micro-SD-kaartlezer      | ⑪ Het toestel resetten |
| ④ Volumeknoppen | ⑧ Mini-HDMI                |                        |





# Installatiewizard

De eerste keer dat u uw ARCHOS inschakelt, zal de installatiewizard u helpen bij het instellen van uw apparaat :

- Taal
- WiFi-verbinding
- Datum en tijd
- Uw naam
- De locatieservice
- Toepassingen van derden

## **TIPS:**

Definieer de parameters van het apparaat op het gebied van het WiFi-netwerk zult u regelmatig gebruikt.



# WiFi-netwerkverbinding

**WAARSCHUWING:** Controleer of u zich in een WiFi-zone bevindt. Vis de statusbalk heeft u snel toegang tot de WiFi-instellingen.

1. Trek de statusbalk omlaag om deze weer te geven.
2. Raak de balk nogmaals aan om de snelinstellingen weer te geven.
3. Kies het WiFi-pictogram  om de WiFi-verbinding in te schakelen .
4. Kies "WiFi" onder het WiFi-pictogram.
5. Tik op de naam van het netwerk waarmee u verbinding wilt maken. Privé-netwerken worden weergegeven met een slot-pictogram en vereisen de invoer van een wachtwoord.



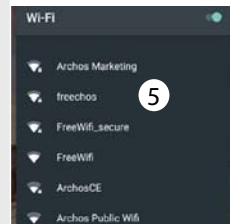
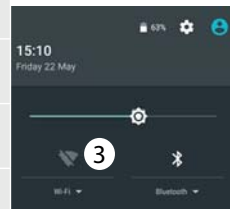

## TIPS:

- Bij het invoeren van een WiFi-wachtwoord, raden wij u aan «Wachtwoord weergeven» te selecteren, zodat u de tekens kunt zien die u aan het typen bent. Neem voor het juiste WiFi-wachtwoord (of instellingen) voor het netwerk contact op met de WiFi-netwerkprovider. Als uw WiFi is ingeschakeld en u zich binnen het bereik van een netwerk bevindt waarmee u al eerder verbinding hebt gemaakt, zal ARCHOS automatisch proberen er opnieuw verbinding mee te maken.
- Om uw WiFi-verbinding ingeschakeld te houden als het apparaat in stand-by is, selecteert u het Menu-pictogram op de WiFi-pagina. Vervolgens selecteert u Advanced > Keep WiFi on during sleep > Always [Geavanceerd > WiFi aan in stand-by > Altijd].





## Verbinding maken met WiFi via WPS

1. Trek de statusbalk omlaag om deze weer te geven.
2. Raak de balk nogmaals aan om de snelinstellingen weer te geven.
3. Kies het WiFi-pictogram  om de WiFi-verbinding in te schakelen .
4. Kies "WiFi" onder het WiFi-pictogram.
5. Kies de Menu-knop  en dan Advanced [Geavanceerd].
6. Kies de WPS-knop.
7. Druk op de knop WiFi Protected Setup (Beveiligde WiFi-configuratie) op uw router. Deze knop is mogelijk voorzien van de naam "WSP" of van een symbool: 

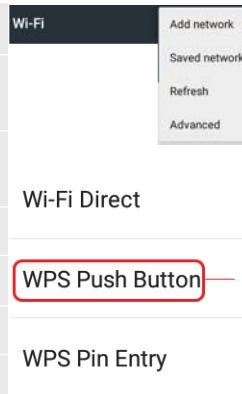



# De Android™-Interface







- ① **Google™ Search**  
> Tik voor zoeken op tekst of zoeken met stem .
- ② **Android™-apps**  
> Tik erop om een applicatie te starten.
- ③ **Snelkoppelingen van permanente Android™-apps**
- ④ **“Knop Alle Apps”**  
> Tik op dit pictogram om alle applicaties en widgets weer te geven die op uw ARCHOS zijn geïnstalleerd. Al uw gedownloade applicaties bevinden zich hier.
- ⑤ **Volumeknoppen +/-**
- ⑥ **Terug**
- ⑦ **Startpagina**
- ⑧ **Recente apps**
- ⑨ **Statusbalk**  
> Geeft meldingen en snelinstellingen weer.



# De Android™-Interface

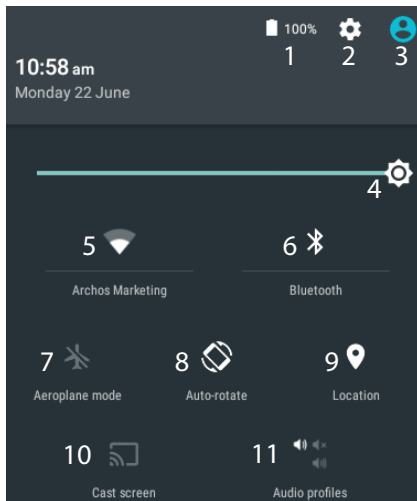

## De Snelinstellingen

- 1 Percentage batterijlading
- 2 Om al uw instellingen te openen.
- 3 Huidige gebruiker\*
- 4 Om de helderheid van het scherm aan te passen.
- 5 Om uw WiFi-verbinding aan/uit te zetten.
- 6 Om uw Bluetooth-verbinding aan/uit te zetten.
- 7 Om alle draadloze verbindingen te activeren/deactiveren, in het bijzonder tijdens het vliegen.
- 8 Om de automatische oriëntatie van het scherm te activeren/deactiveren als u uw ARCHOS draait.
- 9 De locatieservice
- 10 Om uw Android-apparaat te spiegelen op de tv zodat u de content van uw mobiele apparaat op een groot scherm kunt gebruiken.
- 11 Om een waarschuwingstype te kiezen

\*Nieuwe tabletondersteuning voor meerdere gebruikers waarbij iedere gebruiker zijn eigen ruimte op de tablet kan maken en aanpassen. Voeg gebruikers toe bij Settings > Device [Instellingen > Apparaat]





## Recente apps

Hiermee opent u een lijst van miniatuurafbeeldingen van apps waarmee u onlangs hebt gewerkt:

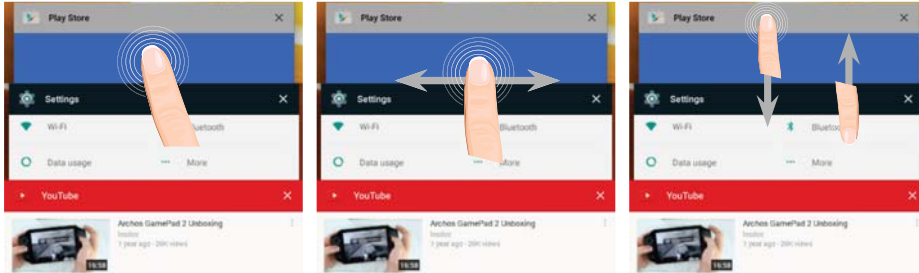

**Aanraken:** een app openen.

**Veeg naar links of rechts:** een app sluiten.

**Omhoog of omlaag bladeren:** om andere recente apps weer te geven.





# ARCHOS Fusion Storage

## Fusion Storage instellen

1. Plaats een micro-SD-kaart in de micro-SD-kaartsleuf van het apparaat.  
Plaats de kaart in de juiste richting.

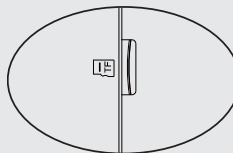

Het apparaat detecteert de micro-SD-kaart automatisch en vraagt u of u de interne opslag wilt samenvoegen met de micro-SD-kaart.

2. Kies "OK".

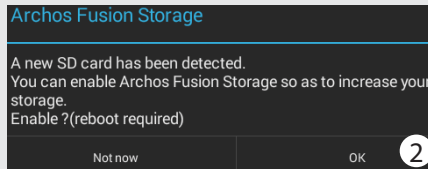

3. Kies "OK" in het venster Optimizing storage [Opslag optimaliseren] om uw keus te bevestigen.

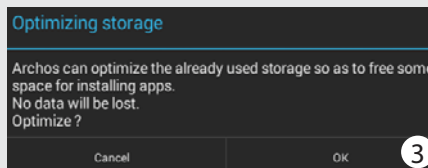



Het apparaat wordt opnieuw opgestart.

- Nadat het apparaat opnieuw is opgestart, krijgt u een melding dat ARCHOS Fusion Storage actief is.
- In de statusbalk wordt een symbool weergegeven.
- Kies de app Settings [Instellingen] en dan ARCHOS Fusion Storage. De samengevoegde opslag wordt weergegeven.

### Fusion Storage uitschakelen

1. Kies de app Settings [Instellingen].
2. Kies de app Settings [Instellingen] en dan ARCHOS Fusion Storage.
3. Wanneer ARCHOS Fusion Storage actief is, kiest u "Disable ARCHOS Fusion Storage" [ARCHOS Fusion Storage uitschakelen] en bevestigt u uw keus.

Het apparaat wordt opnieuw opgestart om de wijzigingen toe te passen.

#### OPTIONS

Disable Archos Fusion Storage  
Get back to the initial configuration

#### Tip:

wij raden u aan om het apparaat uit te schakelen voordat u de micro-SD-kaart plaatst.





# Vertrouwd raken met Android™



## Het verplaatsen van een item op het startscherm:

Tik en houd uw vinger op zijn plaats tot de positioneringsrasterlijnen verschijnen, dan schuift u deze naar de gewenste locatie en laat uw vinger vervolgens weer los.

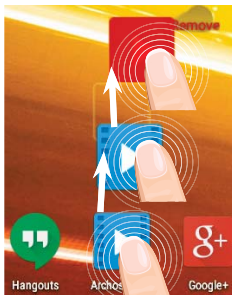

## Het verwijderen van een item op het startscherm:

Tik en houd uw vinger op het item en schuif dit vervolgens naar de bovenkant van het scherm en zet het op het pictogram "Verwijderen".

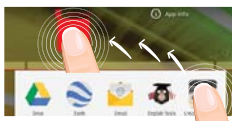

## Verwijderen van een item:

Tik in de schermen Alle apps op het item en houd uw vinger daar, schuif vervolgens uw vinger in de richting van de bovenkant van het scherm en plaats het item op de prullenbak "Verwijderen".



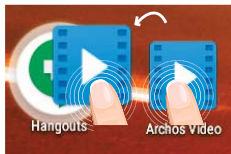

### Het aanmaken van applicatiemappen:

Plaats op een startscherm het ene app-pictogram op het andere, en de twee pictogrammen worden gecombineerd.



### Uw wallpaper wijzigen:

Houd uw vinger op het scherm op een lege plek en maak vervolgens een selectie uit de lijst.



### Widgets:

Houd uw vinger op het scherm op een lege plek en maak vervolgens een selectie uit de lijst: "Widgets".





# Problemen oplossen

---

## **Als uw apparaat vast zit:**

Druk gedurende 10 seconden op de AAN/UIT-knop.

## **Als uw apparaat niet inschakelt:**

1. Laad uw apparaat op.
2. Druk gedurende 10 seconden op de AAN/UIT-knop.

## **Als u de levensduur van uw batterij wilt verlengen:**

Verminder de helderheid van het scherm en schakel de draadloze verbindingen uit indien deze niet in gebruik zijn.

## **Als uw apparaat te traag werkt:**

Sluit alle applicaties die op dat moment niet worden gebruikt.

## **Als uw WiFi-ontvangst te laag is:**

Zorg ervoor dat u zich niet ver van de WiFi-hotspot bevindt.

Update de firmware van het apparaat: <http://www.archos.com/support>.

Reset de instellingen van uw WLAN-verbinding.

Neem contact op met uw WiFi-verbindingsprovider.







# Índice

Conteúdo da embalagem.....	98
Início.....	99
Descrição do ARCHOS.....	100
Assistente de instalação.....	101
Ligação a uma rede WiFi .....	102
A interface Android™.....	104
ARCHOS Fusion Storage.....	108
Familiarização com a tecnologia Android™.....	110
Resolução de problemas.....	112

Para obter mais informações, consulte as Perguntas frequentes em [www.archos.com](http://www.archos.com). Certifique-se de que os consulta antes de colocar a hipótese de devolver qualquer produto. O seu problema pode ser insignificante. Como muitas vezes atualizamos e melhoramos os nossos produtos, o seu software do dispositivo pode ter uma aparência ligeiramente diferente ou funcionalidades modificadas das apresentadas neste Guia de Início Rápido.

Consulte a declaração de conformidade em [http://www.archos.com/products/declaration\\_conformity.html](http://www.archos.com/products/declaration_conformity.html)





# Conteúdo da embalagem



ARCHOS 101c Platinum



Guia do usuário



Garantia, avisos legais e de segurança



Cabo USB



Carregador





# Início

## Carregar a bateria

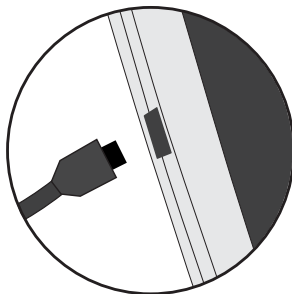

1. Carregue o seu aparelho ligando o cabo de alimentação à Conector de alimentação. O aparelho ARCHOS será iniciado o carregamento.
2. Pressione o botão On / Off para ligar o produto.

- Pode utilizar o seu aparelho ARCHOS enquanto este está a carregar.
- Carregue o dispositivo completamente antes de usá-lo pela primeira vez.
- Use apenas o carregador fornecido.

**Quando o teu dispositivo está descarregado por completo, é necessário ecarregá-lo pelo menos durante 10 minutos antes de ser exibido o ícone da bateria.**

### SUGESTÕES:

Para receber uma assistência mais completa, registre o seu produto.  
No caso de um computador, vá a [www.archos.com/register](http://www.archos.com/register).





# Descrição do ARCHOS

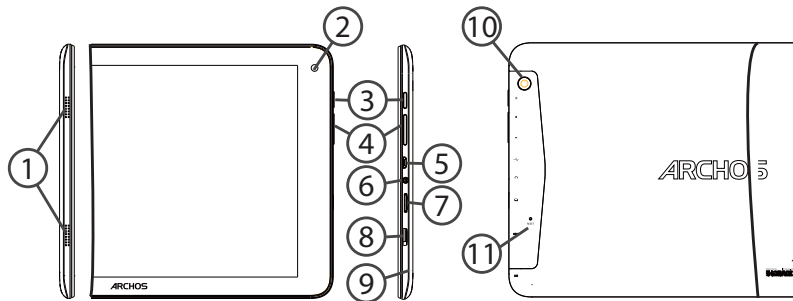

① Colunas

② Webcam

③ Botão Power

④ Botões de volume

⑤ Porta micro-USB

⑥ Saída para auriculares

⑦ Slot para cartão micro SD

⑧ Mini-HDMI

⑨ Microfone incorporado

⑩ Câmera

⑪ Repor hardware





# Assistente de instalação

Quando iniciar o ARCHOS pela primeira vez, o assistente de instalação irá ajudá-lo a configurar o seu aparelho :

- Idioma
- Rede WiFi
- Data e hora
- Seu nome
- Minha localização
- Aplicações de terceiros

## **SUGESTÕES:**



Definir os parâmetros do seu dispositivo na área da rede WiFi você será regularmente usando.





# Ligação a uma rede WiFi

**AVISO:** Certifique-se de que se encontra numa área abrangida por Wi-Fi. Pode aceder rapidamente às definições de Wi-Fi a partir da barra de estado.

1. Toque e puxe para baixo a barra de estado para exibí-la.
2. Toque de novo na barra para revelar as definições rápidas.
3. Selecione o ícone de Wi-Fi  para ativar a ligação Wi-Fi .
4. Selecione “Wi-Fi” abaixo do respetivo ícone.

5. Toque no nome da rede à qual pretende ligar-se.  
As redes privadas são exibidas com um símbolo de cadeado e precisará de introduzir a sua palavra-passe.

## SUGESTÕES:

- Quando introduzir uma palavra-passe WiFi, recomendamos que seleccione “Mostrar palavra-passe” para que possa ver os caracteres que está a digitar. Para obter a palavra-passe (ou definições) WiFi correcta para a rede, contacte a operadora da rede WiFi. Se a sua funcionalidade WiFi estiver ligada e estiver dentro da área de alcance de uma rede à qual já tenha efectuado uma ligação, o seu ARCHOS irá tentar automaticamente ligar-se à mesma.
- Para manter a sua ligação WiFi ligada quando o dispositivo está suspenso, seleccione o ícone do menu na página do WiFi. Em seguida, seleccione Advanced (Avançadas) > Keep WiFi on during sleep [Manter Wi-Fi ligado durante a suspensão] > Always (Sempre)].

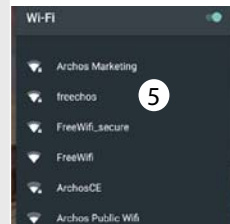
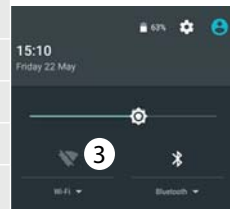



## Ligar à rede Wi-Fi através de WPS

1. Toque e puxe para baixo a barra de estado para exibi-la.

2. Toque novamente na barra para exibir as definições rápidas.

3. Selecione o ícone Wi-Fi  para ativar a ligação Wi-Fi .

4. Selecione "Wi-Fi" abaixo do ícone Wi-Fi.

5. Selecione o botão Menu , seguido de "Advanced" (Avançado).

6. Selecione "WPS Push Button" (Botão de Ativação WPS).

7. Prima o botão configuração protegida Wi-Fi (WPS) no seu router. Poderá chamar-se "WPS" ou conter um símbolo: 

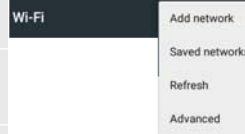

Wi-Fi Direct

WPS Push Button

WPS Pin Entry





# A Interface Android™







- 
- ① **Google™ Search**  
> Toque para efectuar uma pesquisa de texto ou uma busca por voz.
  - ② **Aplicações Android™**  
> Toque para iniciar uma aplicação.
  - ③ **Atalhos permanentes em aplicações Android™**
  - ④ **“Todas as Aplicações”**  
> Toque neste ícone para visualizar todas as aplicações e widgets instalados no seu ARCHOS. Estão aqui todas as aplicações descarregadas.
  - ⑤ **Volume +/-**
  - ⑥ **“Anterior”**
  - ⑦ **“Ecrã Principal”**
  - ⑧ **“Aplicações recentes”**
  - ⑨ **Barra do estado**  
> Apresenta notificações e definições rápidas.



# A Interface Android™

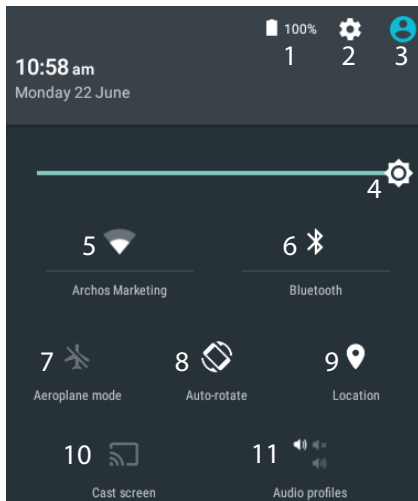

## As Definições rápidas

- 1 Ver a percentagem de bateria que resta
- 2 Para aceder a todas as suas definições.
- 3 Utilizador atual\*
- 4 Para ajustar o brilho do ecrã.
- 5 Para ligar/desligar a sua ligação WiFi.
- 6 Para ligar/desligar a sua ligação Bluetooth.
- 7 Para activar/desactivar todas as ligações sem fios, especialmente durante voos.
- 8 Para activar/desactivar a orientação automática do ecrã enquanto roda o ARCHOS.
- 9 Minha localização.
- 10 Para replicar o seu dispositivo Android no televisor de modo a desfrutar dos excelentes conteúdos tal como apresentados no seu dispositivo móvel.
- 11 Para seleccionar o tipo de notificação.

\*O novo suporte multiutilizador para permite que diferentes utilizadores tenham áreas de trabalho separadas e personalizadas no mesmo dispositivo. Pode adicionar utilizadores em Settings > Device [Definições > Dispositivo]





## Aplicações recentes

Abre uma lista de imagens em tamanho reduzido das aplicações que utilizou recentemente:

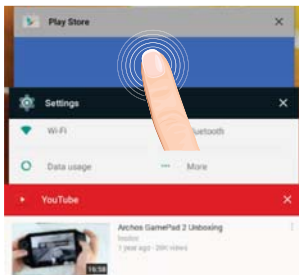

**Toque:** para abrir uma aplicação

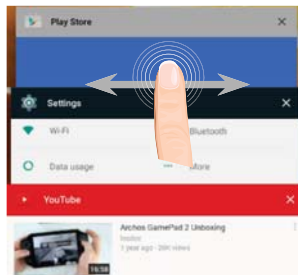

**Deslizar para a esquerda ou para a direita:** para fechar uma aplicação

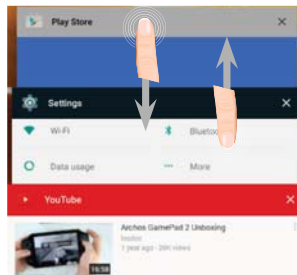

**Navegação vertical:** para consultar outras aplicações recentes.



# ARCHOS Fusion Storage

## Configuração do Fusion Storage

1. Introduza um cartão micro-SD na ranhura respetiva do dispositivo. Certifique-se de que introduz o cartão na direção correta.

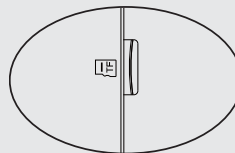

O seu dispositivo irá detetar o cartão micro-SD automaticamente e perguntar-lhe se quer unir o armazenamento interno com o cartão micro-SD.

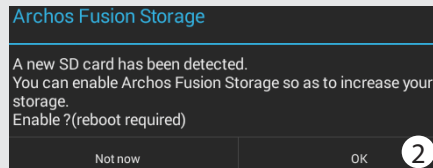

2. Selecione "OK".

3. Selecione "OK" na janela "Optimizing storage" (Otimização do armazenamento) para confirmar a sua escolha.

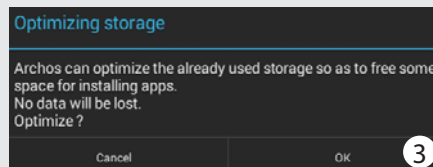



O dispositivo irá reiniciar.

- Quando o dispositivo reiniciar, será informado de que o ARCHOS Fusion Storage está ativo.
- É apresentada uma notificação na barra de estado.
- Selecione a aplicação de "Settings" (Definições), seguida de ARCHOS Fusion Storage. Será apresentado o armazenamento unido.

### Desativar o Fusion Storage.

1. Selecione a aplicação de "Settings" (Definições).
2. Na aplicação de "Settings" (Definições), selecione ARCHOS Fusion Storage.
3. Quando o ARCHOS Fusion Storage estiver ativo, selecione "Disable ARCHOS Fusion Storage" (Desativar ARCHOS Fusion Storage) e confirme.

Para aplicar as alterações, o dispositivo irá reiniciar.

#### OPTIONS

Disable Archos Fusion Storage  
Get back to the initial configuration

### Dica:

Recomendamos que desligue o dispositivo antes de introduzir o cartão micro-SD.





# Familiarizar-se com Android™



## **Mover um item do ecrã inicial:**

Toque continuamente com o dedo no mesmo até aparecer a grelha de posicionamento; em seguida, deslize-o para a posição pretendida e solte o dedo.

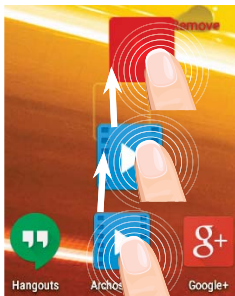

## **Remover um item do ecrã inicial:**

Toque continuamente no mesmo, deslize o seu dedo para o topo do ecrã e largue-o sobre o ícone Remove.

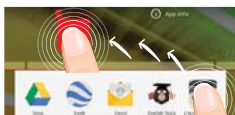

## **Desinstalar um item:**

A partir do ecrã Todas as aplicações, toque continuamente no mesmo, deslize o seu dedo para o topo do ecrã e largue-o sobre o caixote Desinstalar.



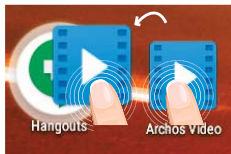

### **Criar pastas de aplicações:**

Largue o ícone de uma aplicação sobre outro num ecrã inicial e os dois ícones ficarão combinados.



### **Alterar a imagem de fundo:**

Mantenha o dedo no ecrã sobre uma localização vazia, em seguida seleccione a partir da lista.



### **Widgets:**

Mantenha o dedo no ecrã sobre uma localização vazia, em seguida seleccione a partir da lista: Widgets.





# Resolução de problemas

---

## **Se o aparelho bloquear:**

Prima o botão LIGAR/DESLIGAR durante 10 segundos.

## **Se o seu aparelho não ligar:**

1. Carregue o aparelho.
2. Prima o botão LIGAR/DESLIGAR durante 10 segundos.

## **Se pretender aumentar a autonomia da bateria:**

Diminua o brilho do ecrã e desligue as ligações sem fios, se não estiverem a ser utilizadas.

## **Se o funcionamento do aparelho for demasiado lento:**

Encerre todas as aplicações que não estejam a ser utilizadas.

## **Se a recepção WiFi for demasiado lenta:**

Certifique-se de que não está afastado do ponto de ligação WiFi.

Atualizar o firmware do dispositivo: <http://www.archos.com/support>.

Redefinir as configurações de sua conexão.

Contacte a sua operadora da ligação WiFi.







# Содержание

Содержимое упаковки .....	114
Начало работы.....	115
Описание устройства.....	116
Мастер настройки.....	117
Подключение к сети Wi-Fi.....	118
A interface Android™.....	120
ARCHOS Fusion Storage.....	124
Знакомство с Android™.....	126
Устранение неполадок.....	128

За дополнительной информацией обратитесь к разделу часто задаваемых вопросов и руководству пользователя для Вашего устройства на сайте [www.archos.com](http://www.archos.com). Обязательно прочтите их прежде, чем задумываться о возврате устройства. Ваша проблема может оказаться не столь уж значительной. Мы часто обновляем и улучшаем свою продукцию, поэтому графический интерфейс или функциональность программного обеспечения Вашего устройства могут несколько отличаться от представленных в настоящем Кратком руководстве пользователя.

Обратитесь к декларации о соответствии на [http://www.archos.com/products/declaration\\_conformity.html](http://www.archos.com/products/declaration_conformity.html)





# Содержимое упаковки



ARCHOS 101c Platinum



Краткое руководство



Гарантии и инструкции по безопасности



Кабель USB

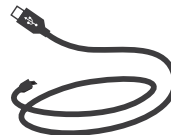

Зарядное устройство





# Начало работы

## Зарядка

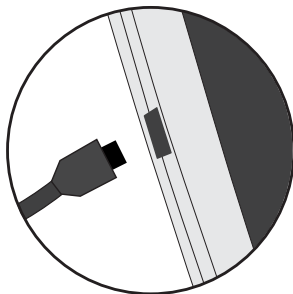

1. Зарядите Ваше устройство, подключив кабель питания к Разъем питания. ARCHOS устройство начнет заряжаться.
2. Нажмите кнопку питания, чтобы включить устройство.

-Вы можете пользоваться устройством ARCHOS во время зарядки.

-Перед первым использование устройство должно полностью зарядиться.

-Разрешается использовать только зарядное устройство из комплекта поставки.

**Если ваше устройство полностью разрядилось, необходимо зарядить его в течение минимум 10 минут, прежде чем сможет отобразиться значок заряжающегося аккумулятора.**

### СОВЕТ:

Зарегистрируйте свое изделие, чтобы получать обслуживание в более полном объеме. При работе с компьютером перейдите по ссылке [www.archos.com/register](http://www.archos.com/register).





# Описание устройства

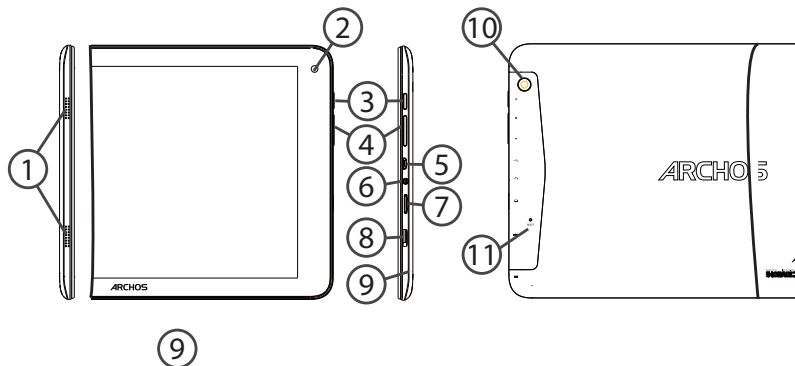

- |                    |                           |                             |
|--------------------|---------------------------|-----------------------------|
| ① громкоговоритель | ⑤ Порт Micro-USB          | ⑨ Микрофон                  |
| ② Веб-камера       | ⑥ Разъем для наушников    | ⑩ Камера                    |
| ③ Кнопка ВКЛ/ВЫКЛ  | ⑦ Слот для карты Micro-SD | ⑪ Кнопка аппаратного сброса |
| ④ Кнопки громкости | ⑧ Mini-HDMI               |                             |





# Мастер настройки

При первом запуске устройства ARCHOS мастер установки поможет выполнить настройку :

- Язык
- Соединение Wi-Fi
- Дата и время
- Ваше имя
- Опции службы геолокации
- Сторонние приложения

## **СОВЕТ:**

Мы рекомендуем выполнять настройку устройства в зоне Wi-Fi сети, которой Вы будете регулярно пользоваться.







# Подключение к сети Wi-Fi

**ПРЕДУПРЕЖДЕНИЕ!** Убедитесь, что вы находитесь в области с покрытием WiFi. Используйте строку состояния для быстрого доступа к настройкам WiFi.

1. Коснитесь строки состояния и потяните ее вниз, чтобы отобразить строку.

2. Повторно коснитесь строки состояния, чтобы открыть быстрые настройки.

3. Выберите пиктограмму WiFi , чтобы активировать подключение WiFi .

4. Выберите WiFi под пиктограммой WiFi.

5. Коснитесь имени сети, к которой необходимо подключиться. Частные сети отображаются с пиктограммой замка; для подключения к ним следует ввести пароль.



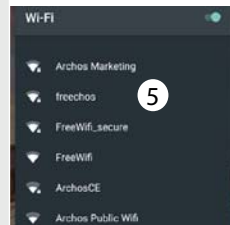
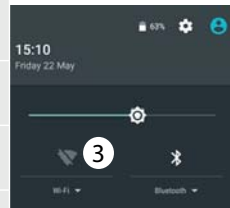

## СОВЕТ:

- При вводе пароля рекомендуется выбрать опцию "Show password", чтобы видеть вводимые символы. Для того, чтобы получить сетевой пароль (или настройки) Wi-Fi, обратитесь к провайдеру сети Wi-Fi. Если связь Wi-Fi включена и Вы находитесь в зоне действия сети, к которой ранее подключились, ARCHOS установит соединение автоматически.
- Чтобы поддерживать соединение WiFi включенным, когда устройство находится в спящем режиме, на странице WiFi выберите значок меню. Затем выберите Advanced > Keep WiFi on during sleep > Always [Дополнительно > Оставить WiFi включенным в спящем режиме > Всегда].





## Подключение к WiFi с помощью WPS

1. Коснитесь строки состояния и потяните ее вниз, чтобы отобразить строку.
2. Повторно коснитесь строки состояния, чтобы открыть быстрые настройки.
3. Выберите пиктограмму WiFi , чтобы активировать подключение WiFi .
4. Выберите WiFi под пиктограммой WiFi.
5. Выберите кнопку Menu («Меню») , затем Advanced («Дополнительные настройки»).
6. Выберите кнопку WPS.
7. Нажмите кнопку WiFi Protected Setup на роутере. Она может называться WPS или содержать символ: 

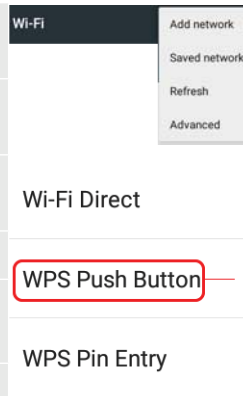



# Интерфейс Android™







- ① **Поиск Google™**  
> Прикоснитесь к позиции «Google», чтобы выполнить тестовый поиск, или к пиктограмме микрофона, чтобы выполнить голосовой поиск.
- ② **Пиктограммы приложений Android™**  
> Прикоснитесь к пиктограмме для запуска приложения.
- ③ **Постоянные ярлыки приложений Android™**
- ④ **Кнопка “Все приложения”**  
> Прикоснитесь к этой пиктограмме, чтобы отобразить все приложения и виджеты, установленные в Вашем ARCHOS. Здесь находятся все загруженные Вами приложения.
- ⑤ **Кнопки громкости**
- ⑥ **Кнопка “Назад”**
- ⑦ **Кнопка “Домой”**
- ⑧ **“Кнопки последних приложений”**
- ⑨ **Строка состояния**  
> Отображаются сообщения и быстрые настройки.





# Интерфейс Android™

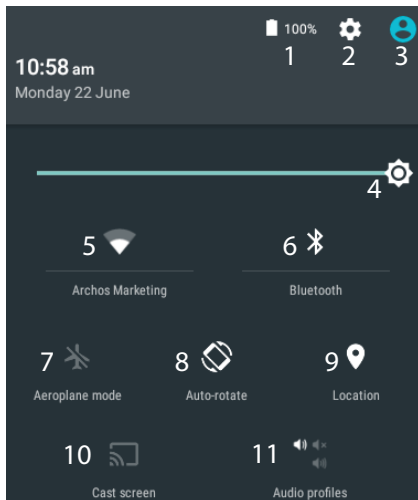

\*Новая многопользовательская поддержка для планшетов предоставляет различным пользователям свое собственное отдельное, конфигурируемое место на одном устройстве. Добавьте пользователей в Settings > Device [Настройки > Устройство].

## Быстрые настройки

- 1 Процентная величина остатка заряда аккумулятора
- 2 Доступ ко всем настройкам.
- 3 Текущий пользователь\*
- 4 Регулировка яркости экрана.
- 5 Включение/выключение соединения Wi-Fi.
- 6 Включение/выключение соединения Bluetooth.
- 7 Активация/деактивация всех беспроводных соединений, в частности, во время авиаперелета.
- 8 Активация/деактивация автоматической ориентации экрана при повороте устройства ARCHOS.
- 9 Опции службы геолокации
- 10 Отобразить экран устройства под управлением ОС Android на телевизоре и наслаждаться великолепным контентом в точности как на мобильном устройстве.
- 11 Выбрать тип уведомления





## Последние приложения

Открывается список эскизов приложений, с которыми Вы недавно работали:

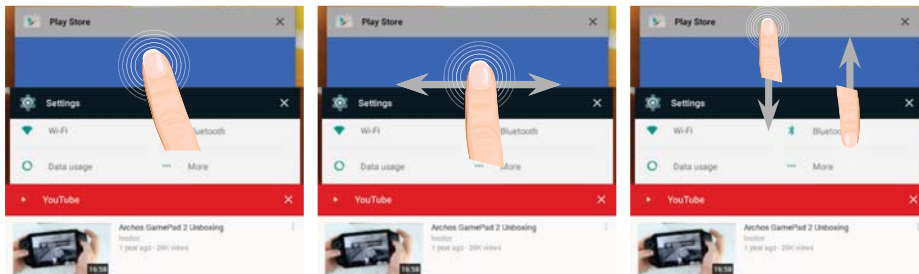

**Коснитесь:** чтобы открыть приложение.

**Проведите пальцем влево или вправо:** закрытие приложения.

**Проведите по экрану пальцем вверх или вниз,** чтобы просмотреть другие последние приложения





# ARCHOS Fusion Storage

## Настройка объединенной памяти устройства

1. Вставьте карту micro-SD в слот для карты micro-SD на устройстве.  
Убедитесь в том, что карта вставлена правильной стороной.

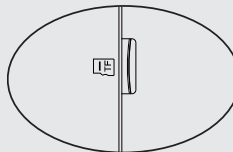

Устройство автоматически определит карту micro-SD и предложит объединить внутреннюю память устройства с картой micro-SD.

2. Нажмите «ОК».

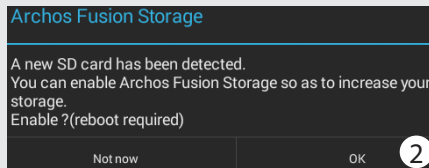

3. Для подтверждения выбора нажмите «ОК» в окне «Оптимизация хранилища».

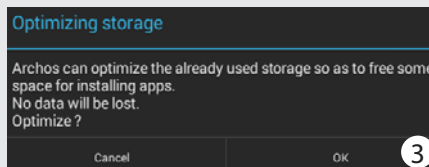



Устройство перезагрузится.

- В процессе перезапуска устройства появится сообщение о том, что объединенное хранилище ARCHOS активировано.
- В строке состояния отображается оповещение.
- Выберите программу Settings (Настройки), а затем — ARCHOS Fusion Storage. Отображается объединенное хранилище.

### Объединенное хранилище ARCHOS

1. Выберите программу Settings (Настройки).
2. В программе настроек выберите ARCHOS Fusion Storage.
3. Если программа ARCHOS Fusion Storage была активирована, выберите Disable ARCHOS Fusion Storage (Деактивировать ARCHOS Fusion Storage) и подтвердите.

Устройство перезагрузится для применения изменений.

#### OPTIONS

Disable Archos Fusion Storage  
Get back to the initial configuration

#### Подсказка:

Перед тем как вставить карту micro-SD, устройство рекомендуется отключить.





# Знакомство с Android™



## Перемещение элемента домашнего экрана:

Прикоснитесь к элементу и удерживайте палец, пока не появится сетка позиционирования, затем переместите его в требуемое положение, и отпустите палец.

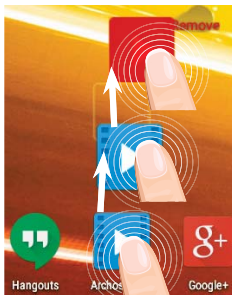

## Удаление элемента домашнего экрана:

Прикоснитесь к элементу и удерживая палец, проведите его к верхней части экрана и отпустите над пиктограммой Remove (удалить).



## Деинсталляция элемента:

Прикоснитесь к элементу на экране «Все приложения» и удерживая палец, проведите его к верхней части экрана и отпустите над пиктограммой Uninstall (деинсталлировать).



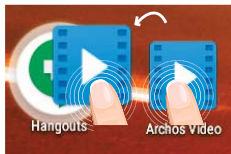

### **Создание папок приложений:**

Поместите пиктограмму одного приложения поверх другого на домашнем экране, и две пиктограммы объединятся.



### **Изменение обоев:**

Удерживайте палец на свободном месте домашнего экрана, затем выберите обои из списка.



### **Виджеты:**

Удерживайте палец на свободном месте домашнего экрана, затем выберите обои из списка: Widgets.





# Устранение неполадок

## **В случае зависания планшета:**

Нажмите на кнопку ВКЛ/ВЫКЛ и удерживайте в течение 10 секунд.

## **Если устройство не включается:**

1. Зарядите устройство.
2. Нажмите на кнопку ВКЛ/ВЫКЛ и удерживайте в течение 10 секунд.

## **Если сенсорный экран функционирует неправильно:**

Выберите значок Settings > восстановление и форматирование), нажмите на значок

Touch-screen calibration (калибровка сенсорного экрана).

## **Если Вы хотите продлить срок работы батареи:**

Уменьшите яркость экрана и выключите беспроводные соединения, если они не используются.

## **Если устройство функционирует слишком медленно:**

Закройте все приложения, которые в данный момент не используются.

## **Если принимаемый сигнал Wi-Fi слишком слаб:**

Убедитесь, что не находитесь слишком далеко от узла доступа Wi-Fi.

Обновите встроенную микропрограмму устройства: <http://www.arnovatech.com/support>.

Сбросьте и повторно введите параметры соединения.

Обратитесь к провайдеру сети Wi-Fi.







# Spis treści

Zawartość opakowania.....	130
Pierwsze uruchomienie.....	131
Opis urządzenia.....	132
Poprzez Wizard.....	133
Nawiązywanie połączenia z siecią Wi-Fi.....	134
Interfejs Android™.....	136
ARCHOS Fusion Storage.....	140
Korzystanie z systemu Android™.....	142
Rozwiązywanie problemów.....	144

Aby uzyskać więcej informacji, należy zapoznać się z najczęściej zadawanymi pytaniami opublikowanymi na stronie [www.archos.com](http://www.archos.com). Należy obowiązkowo zapoznać się ze wspomnianym działem w przypadku rozważania dokonania zwrotu dowolnego produktu. Twój problem być może da się łatwo rozwiązać. Często aktualizujemy i wprowadzamy udoskonalenia w naszych produktach, dlatego też oprogramowanie może nieznacznie różnić się wyglądem lub dostępnością funkcji od tego, co zaprezentowano w skróconej instrukcji obsługi.

Skonsultować deklarację zgodności na [http://www.archos.com/products/declaration\\_conformity.html](http://www.archos.com/products/declaration_conformity.html)





# Zawartość opakowania



ARCHOS 101c Platinum



Skrócona instrukcja obsługi



Gwarancja, oświadczenia prawne  
i informacje dotyczące bezpieczeństwa



Kabel USB



Ładowarka





# Pierwsze uruchomienie

## Ładowanie

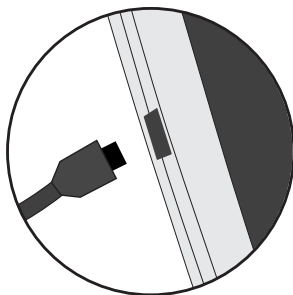

1. Aby naładować urządzenie, podłącz kabel zasilający do Tápcsatlakozó. Urządzenie ARCHOS rozpocznie ładowanie.
2. Naciśnij przycisk zasilania, aby uruchomić urządzenie.

- Podczas ładowania można korzystać z urządzenia ARCHOS.
- Przy pierwszym ładowaniu urządzenia nie należy odłączać urządzenia od źródła zasilania przed pełnym naładowaniem baterii.
- Do ładowania należy wykorzystywać wyłącznie dołączoną ładowarkę.

**Jeśli urządzenie jest całkowicie rozładowane, po podłączeniu go do źródła zasilania należy odczekać przynajmniej 10 minut, aby uruchomiła się ikona z symbolem ładowania.**

### **WSKAZÓWKA:**

Aby móc korzystać z pełnej gamy usług, należy zarejestrować produkt. Można tego dokonać na stronie [www.archos.com/register](http://www.archos.com/register).





## Opis urządzenia

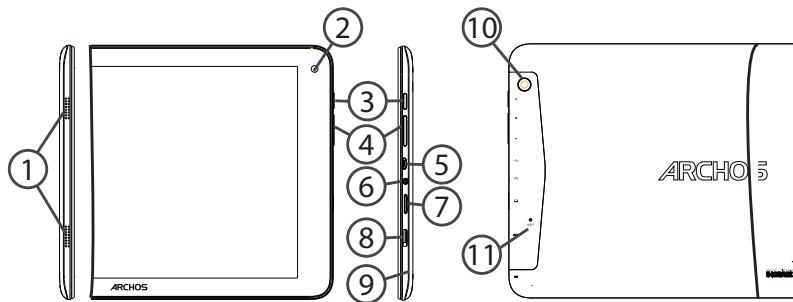

① Głośnik

② Kamera przednia

③ Przycisk zasilania

④ Przyciski regulacji

⑤ Port microUSB

⑥ Wejście słuchawkowe

⑦ Slot na karty micro-SD

⑧ Mini-HDMI

⑨ Mikrofon

⑩ Kamera tylna

⑪ Przycisk Reset





# Korzystanie z kreatora

Po pierwszym uruchomieniu urządzenia ARCHOS kreator instalacji pomoże ci skonfigurować najważniejsze ustawienia:

- Język
- Połączenie Wi-Fi
- Data i godzina
- Twoje imię
- Opcje usług lokalizacyjnych
- Aplikacje od dostawców zewnętrznych

## **WSKAZÓWKA:**



Zalecamy przeprowadzanie konfiguracji urządzenia w strefie zasięgu sieci Wi-Fi, z którą będzie się ono regularnie łączyć.





# Nawiązywanie połączenia z siecią Wi-Fi

**OSTRZEŻENIE:** Upewnij się, że urządzenie znajduje się w zasięgu działania sieci Wi-Fi.  
Skrót do ustawień połączenia Wi-Fi znajduje się na pasku stanu.

1. Dotknij pasek stanu i ściągnij go w dół, aby go wyświetlić.
2. Dotknij pasek ponownie, aby odsłonić szybkie ustawienia.
3. Wybierz ikonę Wi-Fi , aby uaktywnić połączenie Wi-Fi .
4. Wybierz „Wi-Fi” poniżej ikony Wi-Fi.

5. Dotknij nazwę sieci, z którą chcesz się połączyć.  
Sieci prywatne wyświetlane są z ikoną kłódki – aby się z nimi połączyć, musisz wprowadzić hasło.

## **WSKAZÓWKI:**

- Wpisując hasło do sieci Wi-Fi, zalecamy zaznaczenie opcji „Show password” (pokaż hasło), tak aby mieć podgląd wprowadzanych znaków. Hasło do sieci Wi-Fi (lub ustawienia sieci) można otrzymać od administratora sieci. Jeśli opcja łączności Wi-Fi jest aktywna, a urządzenie ARCHOS znajduje się w zasięgu sieci, z którą wcześniej się łączyło, zostanie podjęta automatyczna próba nawiązania połączenia z siecią.
- Aby połączenie z siecią Wi-Fi było aktywne również w trybie uśpienia urządzenia, zaznacz ikonę Menu na stronie Wi-Fi. Następnie wybierz opcję Advanced > Keep WiFi on during sleep > Always (zaawansowane > uruchom sieć Wi-Fi w trybie uśpienia > zawsze).

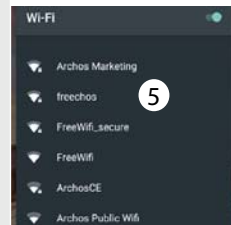
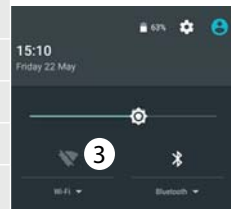





## Łączenie z Wi-Fi przy użyciu standardu WPS

1. Dotknij pasek stanu i ściągnij go w dół, aby go wyświetlić.

2. Dotknij pasek ponownie, aby wyświetlić szybkie ustawienia.

3. Wybierz ikonę Wi-Fi , aby uaktywnić połączenie Wi-Fi .

4. Wybierz „Wi-Fi” poniżej ikony Wi-Fi.

5. Wybierz przycisk Menu , a następnie opcję „Advanced” (zaawansowane).

6. Wybierz przycisk WPS.

7. Naciśnij przycisk WiFi Protected Setup na routerze. Może nosić nazwę „WPS” lub zawierać symbol: .

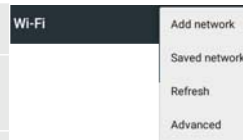

Wi-Fi Direct

WPS Push Button

WPS Pin Entry





# Interfejs Android™







- ① **Wyszukiwarka Google™**  
> Dotknij „Google”, aby skorzystać z funkcji wyszukiwania tekstowego lub dotknij ikonę mikrofonu, aby rozpocząć wyszukiwanie głosowe.
- ② **Skróty do aplikacji dla systemu Android™**  
> Dotknij, aby uruchomić aplikację.
- ③ **Android™ Stała aplikacje skróty**  
> Dotknij, aby uruchomić aplikację.
- ④ **Przycisk „All Apps” (wszystkie aplikacje)**  
> Dotknij tę ikonę, aby wyświetlić wszystkie aplikacje i widżety zainstalowane w twoim urządzeniu ARCHOS. Tutaj widoczne są wszystkie pobrane aplikacje.
- ⑤ **Wolumen + / -**
- ⑥ **Przycisk Wstecz**
- ⑦ **Przycisk ekranu głównego**
- ⑧ **Przycisk ostatnio używanych aplikacji**
- ⑨ **Pasek stanu urządzenia**  
> Wyświetla powiadomienia i skróty do najważniejszych ustawień.



# Interfejs Android™

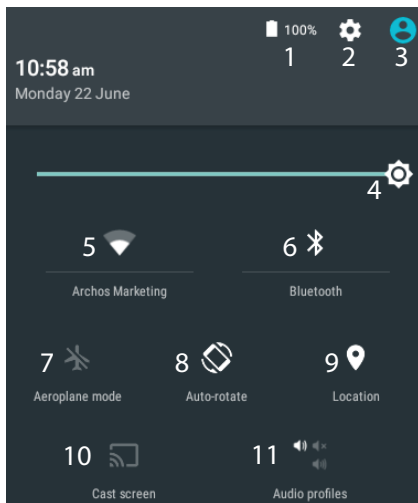

## Szybka konfiguracja

- 1 Stan naładowania baterii
- 2 Dostęp do opcji ustawień.
- 3 Bieżący użytkownik\*
- 4 Regulacja jasności ekranu.
- 5 Włączanie/wyłączanie łącza Wi-Fi.
- 6 Włączanie/wyłączanie łącza Bluetooth.
- 7 Aktywacja/dezaktywacja opcji łączności bezprzewodowej (tzw. tryb samolotowy).
- 8 Aktywacja/dezaktywacja funkcji automatycznej zmiany orientacji ekranu przy obracaniu urządzeniem ARCHOS.
- 9 Usługi lokalizacyjne
- 10 Wyświetlanie zawartości urządzenia z systemem operacyjnym Android na ekranie telewizora.
- 11 Wybór rodzaju powiadamiania

\*New multi-user support for tablets lets different users have their own separate, customizable spaces on a single device. Add users in Settings > Device.



## Ostatnio używane aplikacje

Otwiera listę miniatur ikon aplikacji, z których ostatnio korzystano:

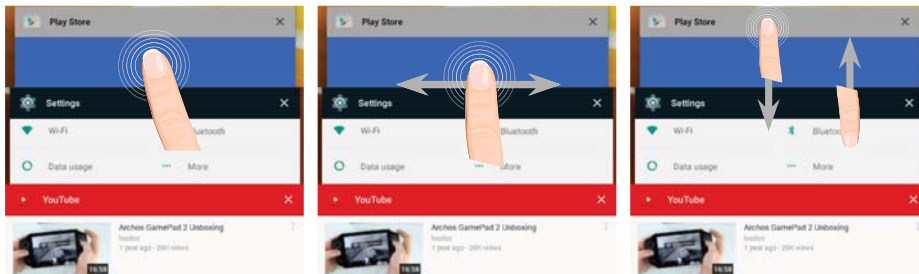

**Dotknij:** aby uruchomić aplikację.

**Przesuń w lewo lub w prawo:** aby zamknąć aplikację.

**Przewiń w górę lub w dół:** wyświetlanie innych najnowszych aplikacji





# ARCHOS Fusion Storage

## Konfigurowanie pamięci Fusion Storage

1. Włóż kartę micro-SD w gniazdo karty micro-SD urządzenia.  
Uważaj, aby karta była wkładana w dobrym kierunku.

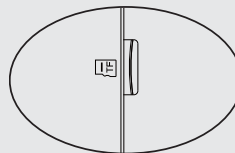

Urządzenie automatycznie wykryje kartę micro-SD i zaproponuje scalenie wewnętrznej pamięci masowej z kartą micro-SD.

2. Wybierz „OK”.

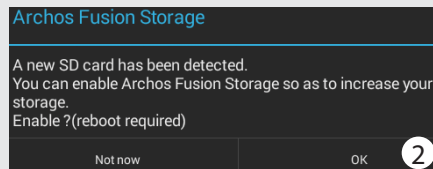

3. Wybierz „OK” w oknie Optimizing storage, aby potwierdzić wybór.

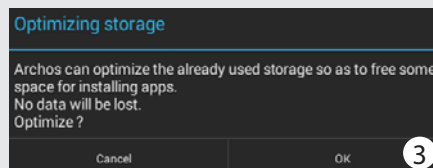



Urządzenie zostanie zrestartowane.

- Po zrestartowaniu urządzenia zostanie wyświetlony komunikat informujący o tym, że pamięć ARCHOS Fusion Storage jest aktywna.
- Na pasku stanu wyświetlone zostanie powiadomienie.
- Wybierz aplikację Ustawienia, a następnie ARCHOS Fusion Storage. Wyświetlona zostanie scalona pamięć masowa.

### Dezaktywowanie pamięci Fusion Storage

1. Wybierz aplikację Ustawienia.
2. W aplikacji Ustawienia wybierz ARCHOS Fusion Storage.
3. Jeśli funkcja ARCHOS Fusion Storage jest aktywna, wybierz „Disable ARCHOS Fusion Storage” i potwierdź. Urządzenie zostanie zrestartowane, aby zmiany mogły zostać zastosowane.

#### OPTIONS

Disable Archos Fusion Storage  
Get back to the initial configuration

### Wskazówka:

Zalecamy wyłączenie urządzenia przed włożeniem do niego karty micro-SD.





# Korzystanie z systemu Android™



## Przenoszenie elementu z ekranu głównego:

Dotknij i przytrzymaj palec na wybranym elemencie aż do wyświetlenia linii pozycjonowania, a następnie przesuń ikonę w wybrane miejsce i zwolnij ją.

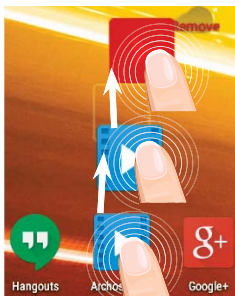

## Usuwanie elementu z ekranu głównego:

Dotknij i przytrzymaj wybrany element, przesuń palec w górę ekranu i upuść element nad ikoną usuwania.



## Usuwanie elementu:

Na ekranie wszystkich aplikacji dotknij i przytrzymaj wybrany element, przesuń palec w górę ekranu i upuść element nad ikoną usuwania.



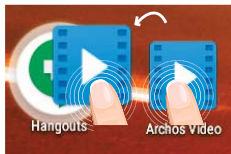

### **Tworzenie folderów aplikacji:**

Upuść ikonę jednej aplikacji nad kolejną na ekranie głównym, aby je połączyć.



### **Zmiana tapety:**

Przytrzymaj palec w pustym miejscu ekranu głównego, a następnie wybierz tapetę z listy.



### **Widżety:**

Przytrzymaj palec w pustym miejscu ekranu głównego, a następnie wybierz tapetę z listy: widżetów.





# Rozwiązywanie problemów

## **Jeśli urządzenie zawiesi się:**

Naciśnij i przytrzymaj przycisk zasilania przez 10 sekund.

## **Jeśli urządzenie nie uruchomi się:**

1. Naładuj urządzenie.
2. Naciśnij i przytrzymaj przycisk zasilania przez 10 sekund.

## **Jeśli chcesz wydłużyć żywotność baterii:**

Reguluj jasność ekranu w zależności od oświetlenia otoczenia i wyłączaj funkcje łączności bezprzewodowej, gdy z nich nie korzystasz.

## **Jeśli urządzenie działa zbyt wolno:**

Zamknij wszystkie otwarte aplikacje.

## **Jeśli sygnał Wi-Fi jest zbyt słaby:**

Upewnij się, że nie znajdujesz się w zbyt dużej odległości od punktu dostępowego Wi-Fi.

Zaktualizuj oprogramowanie wbudowane: <http://www.archos.com/support>.

Zresetuj i zmień parametry łączności.

Skontaktuj się z dostawcą usług sieci Wi-Fi.







# Tartalomjegyzék

A csomag tartalma.....	146
Első lépések.....	147
A készülék bemutatása.....	148
Beállítás a varázsló segítségével.....	149
Csatlakozás Wi-Fi hálózathoz.....	150
Az Android™ kezelőfelülete.....	152
ARCHOS Fusion Storage.....	156
Az Android™ megismerése.....	158
Hibaelhárítás.....	160

Ha további információra van szüksége, keresse a FAQ [GYIK] részt a [www.archos.com](http://www.archos.com) weboldalon. Feltétlenül olvassa el, mielőtt visszaküldené a terméket. Lehet, hogy a probléma nem is olyan nagy probléma. Termékeink rendszeres frissítése és fejlesztése miatt előfordulhat, hogy az Ön készülékének szoftvere némiképp eltérően jelenik meg, vagy kismértékben eltérőek a funkciói a jelen Rövid felhasználói útmutatóban olvasottakhoz képest. Nézze meg a megfelelőségi nyilatkozatát a [http://www.archos.com/products/declaration\\_conformity.html](http://www.archos.com/products/declaration_conformity.html)





# A csomag tartalma



ARCHOS 101c Platinum



Rövid felhasználói útmutató



Jótállási, jogi és biztonsági  
információkat tartalmazó füzet



USB-kábel

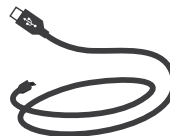

Töltő





# Első lépések

## Töltés

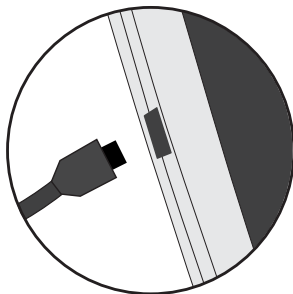

1. A készülék töltéséhez csatlakoztassa a tápkábelt a tápcsatlakozó. Az ARCHOS készülék tölneni kezd.
2. A készülék bekapcsolásához nyomja meg a bekapcsológombot.

- Töltés közben is használhatja ARCHOS készülékét.
- Az első használat előtt teljesen töltsen fel a készüléket.
- Csak a mellékelt töltőt használja.

**Ha a készülék teljesen lemerült, legalább 10 percig kell töltenie ahhoz, hogy az akkumulátortöltést jelző ikon megjelenjen.**

### TIPP:

Ha teljesebb körű szolgáltatáshoz szeretne jutni, regisztrálja készülékét. Nyissa meg számítógépen a [www.archos.com/register](http://www.archos.com/register) weboldalt.





# A készülék bemutatása

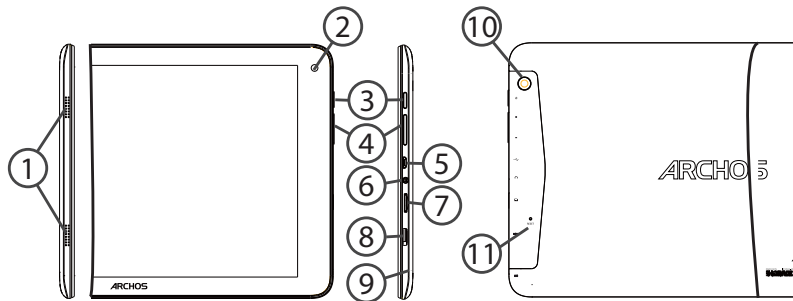

① Hangszóró

② Elülső kamera

③ Hangerő-szabályozó gombok

④ Főkapcsoló

⑤ Micro USB-port

⑥ Fejhallgató-csatlakozó

⑦ Micro-SD kártya slot

⑧ Mini-HDMI

⑨ Mikrofon

⑩ Back kamera

⑪ Reset gomb





# Beállítás a varázsló segítségével

Az ARCHOS első indításakor a telepítési varázsló segít a készülék beállításában:

- Nyelv
- Wi-Fi kapcsolat
- Dátum és idő
- A neved
- Helymeghatározó szolgáltatás beállításai
- Harmadik féltől származó alkalmazások

## **TIPP:**

Javasoljuk, hogy annak a hálózatnak a Wi-Fi zónájában végezze a készülék beállítását, amelyiket rendszeresen használni fogja.





# Csatlakozás Wi-Fi hálózathoz

**FIGYELEM!** Győződjön meg róla, hogy Wi-Fi zónában tartózkodik. Az állapotjelző sávról gyorsan elérheti a Wi-Fi beállításokat.

1. A megjelenítéshez érintse meg és húzza lefelé az állapotjelző sávot.
2. A gyorsbeállítások felfedéséhez ismét érintse meg a sávot.
3. Válassza ki a Wi-Fi ikont a Wi-Fi kapcsolat aktiválásához.
4. Válassza ki a „WiFi” elemet a Wi-Fi ikon alatt.

5. Érintse meg annak a hálózatnak a nevét, amelyikhez csatlakozni szeretne. A magánhálózatok mellett lakat szimbólum látható, és jelszó megadását kéri.



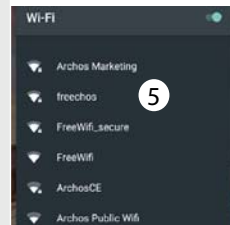
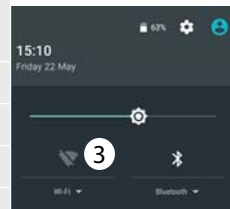

## TIPPEK:

- Javasoljuk, hogy Wi-Fi jelszó megadásakor jelölje be a „Show password” [Jelszó megjelenítése] opciót, így láthatja a beírt karaktereket. A hálózat helyes Wi-Fi jelszava (vagy beállításai) tekintetében forduljon a Wi-Fi szolgáltatóhoz. Ha a Wi-Fi funkció be van kapcsolva, és egy olyan hálózat hatókörében tartózkodik, amelyhez korábban már kapcsolódott, az ARCHOS automatikusan megpróbál kapcsolódni hozzá.
- Ha szeretné bekapcsolva tartani a Wi-Fi opciót a készülék alvó üzemmódjában, nyomja meg a Menü [Menü] ikont a „Wi-Fi” oldalon. Ezután válassza az Advanced > Keep WiFi on during sleep > Always [Speciális > Wi-Fi maradjon bekapcsolva alvó üzemmódban > Mindig] lehetőséget.





## Csatlakozás Wi-Fi hálózathoz WPS használatával

1. A megjelenítéshez érintse meg és húzza lefelé az állapotjelző sávot.
2. A gyorsbeállítások felfedéséhez ismét érintse meg a sávot.
3. Válassza ki a Wi-Fi ikont  a Wi-Fi kapcsolat  aktiválásához.
4. Válassza ki a „WiFi” elemet a Wi-Fi ikon alatt.
5. Válassza ki a Menu [Menü] gombot , majd az Advanced [Speciális] lehetőséget.
6. Válassza ki a WPS Push Button [WPS nyomógomb] lehetőséget.
7. Nyomja meg az útválasztón lévő WiFi Protected Setup [Wi-Fi védett beüzemelés] gombot. Előfordulhat, hogy a gomb neve „WPS”, illetve a következő szimbólum látható rajta: 

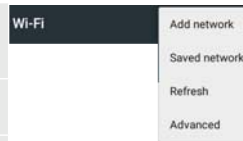

Wi-Fi Direct

WPS Push Button

WPS Pin Entry



# Az Android™ kezelőfelülete

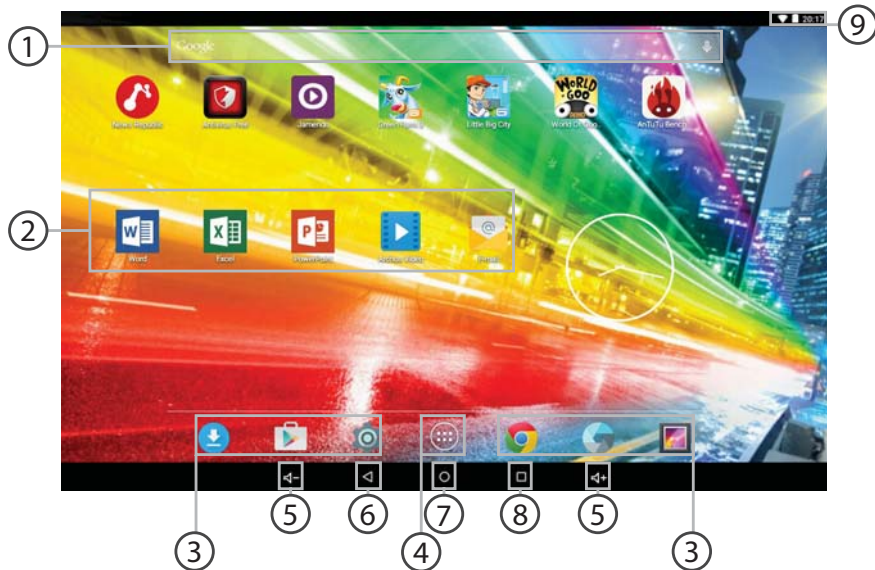





- ① **Google™ keresés**  
> Szöveges kereséshez érintse meg a „Google” felületet, hangos kereséshez érintse meg a mikrofon ikont.
- ② **Android™ alkalmazások parancsikonjai**  
> Egy alkalmazás elindításához érintse meg.
- ③ **Állandó Android™ apps hivatkozások**  
> Egy alkalmazás elindításához érintse meg.
- ④ **„Összes alkalmazás” gomb**  
> Az ARCHOS készülékre telepített összes alkalmazás és minialkalmazás megjelenítéséhez érintse meg ezt az ikont. Az összes letöltött alkalmazást itt találja.
- ⑤ **Hangerő + / -**
- ⑥ **„Vissza” gomb**
- ⑦ **„Legutóbbi alkalmazások” gomb**
- ⑧ **„Kezdőképernyő” gomb**
- ⑨ **Állapotjelző sáv**  
> Értesítések és gyorsbeállítások megjelenítése.



# Az Android™ kezelőfelülete

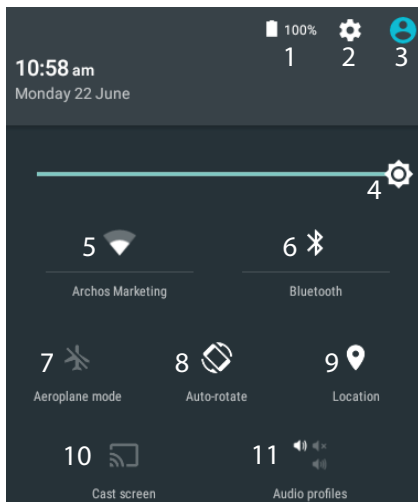

\*Az új táblagépek több felhasználót támogatnak; ez a funkció lehetővé teszi, hogy különböző felhasználók saját, testreszabott felülettel rendelkezzenek egyetlen készüléken. Felhasználókat a Settings > Device [Beállítások > Készülék] pontban adhat hozzá.

## A gyorsbeállítások

- 1 Akkumulátor töltöttsége (%)
- 2 A beállítások megnyitása
- 3 Aktuális felhasználó\*
- 4 A képernyő fényerejének beállítása
- 5 A Wi-Fi kapcsolat be- és kikapcsolása
- 6 A Bluetooth kapcsolat be- és kikapcsolása
- 7 Az összes vezeték nélküli kapcsolat be- és kikapcsolása, elsősorban repülés közben
- 8 Az automatikus képernyőtájolás aktiválása/deaktiválása az ARCHOS készülék elforgatásakor
- 9 Helymeghatározó szolgáltatás
- 10 Az Android eszköz tartalmának megjelenítése a tévé képernyőjén, hogy pontosan úgy élvezhesse az adott tartalmat, mint a mobilkészülék kijelzőjén.
- 11 Értesítés típusának kiválasztása



## A legutóbbi alkalmazások

Megnyitja azon alkalmazások miniatűr képeinek listáját, amelyekkel legutóbb dolgozott:

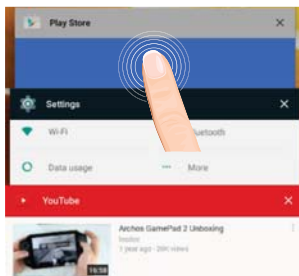

**Érintés:** alkalmazás megnyitása

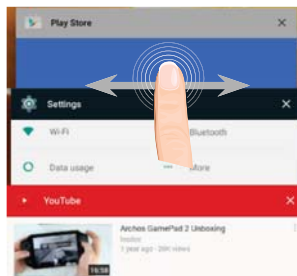

**Lapozunk balra vagy jobbra:** alkalmazás bezárása

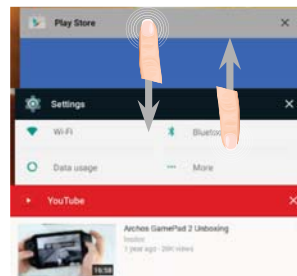

**Felfelé/lefelé görgetés:** a legutóbbi alkalmazások megjelenítése





# ARCHOS Fusion Storage

## A fúziós tárolás beállítása

1. Helyezzen be microSD kártyát a készülék microSD kártyanyílásába. Győződjön meg róla, hogy a helyes irányban helyezi be a kártyát.

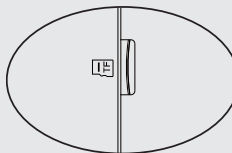

A készülék automatikusan érzékeli a microSD kártyát, és felajánlja, hogy egyesíti a belső tárhelyet a microSD kártyával.

2. Válassza az „OK” gombot.

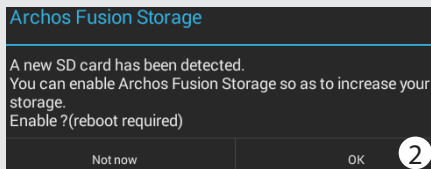

3. Választása megerősítéséhez válassza az „OK” gombot az Optimizing storage [Tárolás optimalizálása] ablakban.

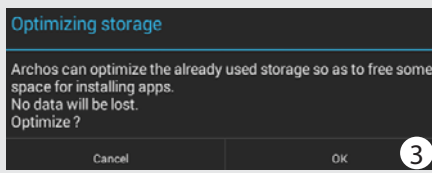



A készülék újraindul.

- A készülék az újraindítást követően tájékoztatja, hogy az ARCHOS fúziós tárolás aktív.
- Az állapotjelző sávon értesítés jelenik meg.
- Válassza ki a Settings [Beállítások] alkalmazást, majd az ARCHOS Fusion Storage funkciót. Megjelenik az egyesített tárhely.

### A fúziós tárolás kikapcsolása

1. Válassza ki a Settings [Beállítások] alkalmazást.
2. A Settings [Beállítások] alkalmazásban válassza ki az ARCHOS Fusion Storage funkciót.
3. Ha az ARCHOS Fusion Storage funkció aktív, válassza ki a „Disable ARCHOS Fusion Storage” [ARCHOS Fusion Storage kikapcsolása] lehetőséget, és erősítse meg a döntését.

A módosítások alkalmazásához a készülék újraindul.

#### OPTIONS

**Disable Archos Fusion Storage**  
Get back to the initial configuration

#### **Tipp:**

A microSD kártya behelyezése előtt ajánlott kikapcsolni a készüléket.





# Az Android™ megismerése



## Elem áthelyezése a kezdőképernyőn:

Érintse meg az ujjával, és tartsa lenyomva, míg a koordinátahálózat meg nem jelenik, utána húzza a kívánt helyre, és emelje fel az ujját.

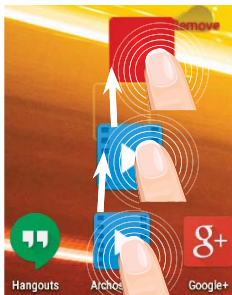

## Elem törlése a kezdőképernyőn:

Érintse meg az ujjával az adott elemet, tartsa lenyomva, majd húzza az ujját a képernyő teteje felé, és engedje el a Törlés ikon felett.

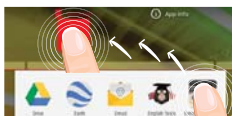

## Elem eltávolítása:

Az Összes alkalmazás képernyőn érintse meg az ujjával az adott elemet, tartsa lenyomva, majd húzza az ujját a képernyő teteje felé, és engedje el az Eltávolítás kosár felett.



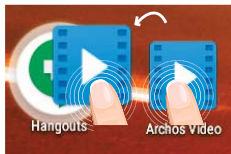

### Alkalmazsmappák létrehozása:

Ha egy alkalmazás ikont egy másik fölé húz egy kezdőképernyőn, majd elengedi, azzal összekapcsolja a két ikont.



### Háttérkép megváltoztatása:

Tartsa az ujját egy kezdőképernyőn egy üres helyen, majd válasszon a listából.



### Minialkalmazások:

Tartsa az ujját egy kezdőképernyőn egy üres helyen, majd válasszon a listából: Widgets.





# Hibaelhárítás

---

## **Ha a készülék lefagyott:**

Tartsa lenyomva a főkapcsolót 10 másodpercig.

## **Ha a készülék nem kapcsol be:**

1. Töltse fel a készüléket.
2. Tartsa lenyomva a főkapcsolót 10 másodpercig.

## **Ha szeretné meghosszabbítani az akkumulátor rendelkezésre állási idejét:**

Csökkentse a képernyő fényerejét, és kapcsolja ki a vezeték nélküli kapcsolatokat, ha épp nem használja őket.

## **Ha a készülék túl lassú:**

Zárja be a nem használt alkalmazásokat.

## **Ha a Wi-Fi vétel túl alacsony:**

Győződjön meg róla, hogy elég közel van a Wi-Fi hotspothoz.  
Frissítse a készülék firmware-ét: <http://www.archos.com/support>.  
Állítsa vissza és állítsa be újra a csatlakozási paramétereket.  
Forduljon a Wi-Fi szolgáltatóhoz.







## National restrictions

This device is intended for home and office use in all EU countries (and other countries following the EU directive 1999/5/EC) without any limitation except for the countries mentioned below:

Country	Restriction	Reason/remark
Bulgaria	None	General authorization required for outdoor use and public service
France	Outdoor use limited to 10 mW e.i.r.p. within the band 2454-2483.5 MHz	Military Radiolocation use. Refarming of the 2.4 GHz band has been ongoing in recent years to allow current relaxed regulation. Full implementation planned 2012
Italy	None	If used outside of own premises, general authorization is required.
Luxembourg	None	General authorization required for network and service supply (not for spectrum)
Norway	Implemented	This subsection does not apply for the geographical area within a radius of 20 km from the centre of Ny-Ålesund
Russian Federation	None	Only for indoor applications

Note: Frequency 2454-2483.5MHz are restricted to indoor use in France.

Consult the declaration of conformity on [http://www.archos.com/products/declaration\\_conformity.html](http://www.archos.com/products/declaration_conformity.html)





### Open Source Software Offer

The software bundled with this product includes software files subject to certain open source license requirements. Such open source software files are subject solely to the terms of the relevant open source software license. Such open source software is provided on an “AS IS” basis to the maximum extent permitted by applicable law.

For the open source files contained herein, please access “Open source license” section located at: Settings>About tablet\Legal information on the device for the relevant copyright and licensing terms. You may obtain a copy of Apache License, Version 2.0 at <http://www.apache.org/licenses/LICENSE-2.0>. You may also obtain a copy of GNU General Public License, Version 2 at the Free Software Foundation, INC, 51 Franklin Street, Fifth Floor, Boston, MA 02110-1301, USA.

Until the date that is three years after our last shipment of this product, you may obtain a copy of the source code corresponding to the binaries for any GPL-Licensed file by contacting ARCHOS customer service at <http://www.archos.com> and ARCHOS will send you a link to such source code or will provide instructions to get the source on a physical medium.

This offer is valid to anyone in receipt of this information.

Archos company declares that this device is in compliance with the essential requirements and other relevant provisions of Directive 1999/5/EC

# CE 1313

