



USER GUIDE

LG-V940n



Welcome!

ENGLISH

Thank you for choosing LG. Please carefully read this user guide before using the device for the first time to ensure safe and proper use.

- Always use genuine LG accessories. The supplied items are designed only for this device and may not be compatible with other devices.
- This device is not suitable for people who have a visual impairment due to the touchscreen keyboard.
- Descriptions are based on the device's default settings.
- Default apps on the device are subject to updates and support for these apps may be withdrawn without prior notice. If you have any questions about an app provided with the device, please contact a LG Service Center. For user-installed apps, please contact the relevant service provider.
- Modifying the device's operating system or installing software from unofficial sources may damage the device and lead to data corruption or data loss. Such actions will violate your LG licence agreement and void your warranty.
- Some contents and illustrations may differ from your device depending on the region, service provider, software version, or OS version, and are subject to change without prior notice.

Instructional notices

 WARNING	Situations that could cause injury to yourself or others.
Caution!	Situations that could cause damage to the device or other equipment.
NOTE	Notice or additional information.
TIP!	Tips for using the function.

Table of contents

Important notice	4	Connecting to Networks and Devices	34
Getting to know your device	7	Wi-Fi	34
Device layout	7	Bluetooth	35
Charging the battery	9	Wi-Fi Direct	36
Installing the microSD card	10	SmartShare	37
Removing the memory card	11	QPair	38
Locking and unlocking the device	11	Transferring data between a PC and your device	40
Your Home screen	13	Contacts	41
Touch screen tips	13	Searching for a contact	41
Home screen	14	Adding a new contact	41
Customizing the Home screen	15	Favorite contacts	41
Returning to recently-used applications	17	Creating a group	42
Notifications panel	17	E-mail	43
On-screen keyboard	20	Setting up email accounts	43
Special Features	23	Composing and sending email	43
Gesture shot	23	Camera and Video	44
KnockON	24	Camera options on the viewfinder	44
Knock Code	24	Using the advanced settings	45
Dual window	25	Taking a photo	46
QuickMemo+	26	Once you have taken a photo	46
QSlide	29	Recording a video	47
QuickRemote	30	After recording a video	48
Google Account Setup	32	Gallery	49
Creating your Google account	32	Multimedia	53
Signing into your Google account	32	Music	53

Utilities	55	Accessories	78
Clock.....	55	Troubleshooting	79
Calculator	56	For Your Safety	81
Calendar.....	56		
Voice Recorder	57		
Voice Search.....	57		
Downloads	57		
LG SmartWorld	58		
Browsing the Web	59		
Chrome	59		
Settings	60		
WIRELESS NETWORKS.....	60		
DEVICE	61		
PERSONAL.....	65		
SYSTEM.....	68		
LG Bridge	72		
Software Update	75		
Device Software Update.....	75		
LG Device Software Update via Over-the-Air (OTA)	75		
About this user guide	76		
About this user guide.....	76		
Trademarks	77		
Trademarks	77		
DivX HD	77		
Dolby Digital Plus.....	77		

Important notice



Please read this before you start using your device!

Please check to see whether any problems you encountered with your device are described in this section before taking the device in for service or calling a service representative.

1. Device memory

You may need to check your device memory and delete some data, such as applications to make more memory available.

To uninstall applications:

- 1 Tap  >  >  > **Apps**.
- 2 Once all applications appear, scroll to and select the application you want to uninstall.
- 3 Tap **Uninstall**.

2. Optimizing battery life

Extend your battery's power by turning off features that you do not need to run constantly in the background. You can monitor how applications and system resources consume battery power.

Extending your device's battery life:

- Turn off radio communications when you are not using. If you are not using Wi-Fi, Bluetooth® or GPS, turn them off.
- Reduce screen brightness and set a shorter screen timeout.
- Turn off automatic syncing for Gmail, Calendar, Contacts and other applications.

- Some applications you download may consume battery power.
- While using downloaded applications, check the battery charge level.



3. Before installing an open source application and OS

WARNING

- If you install and use an OS other than the one provided by the manufacturer it may cause your device to malfunction. In addition, your device will no longer be covered by the warranty.
- To protect your device and personal data, only download applications from trusted sources, such as Play Store™. If there are improperly installed applications on your device, the device may not work normally or a serious error may occur. You must uninstall those applications and all associated data and settings from the device.

4. Opening and switching applications

Multitasking is easy with Android; you can keep more than one application running at the same time. There is no need to quit an application before opening another. Use and switch between several open applications. Android manages each application, stopping and starting them as needed to make sure that idle applications don't consume resources unnecessarily.

- 1 Tap . App previews of recently used applications will be displayed.
- 2 Tap the application you want to access. This does not stop the previous app from running in the background. Make sure to tap  to back out of an app after using it.
 - To close an app from the recent apps list, swipe the app preview to the left or right.
To clear all apps, tap **Clear all**.

5. If the screen freezes

If the screen freezes or the device does not respond when you try to operate it:

Press and hold the **Power/Lock Key** and **Volume Down Key** for about 9 seconds to reset your device. To turn your device off, press and hold the **Power/Lock Key** and **Volume Down Key** for about 15 seconds. If it still does not work, please contact the service center.

Getting to know your device

Device layout

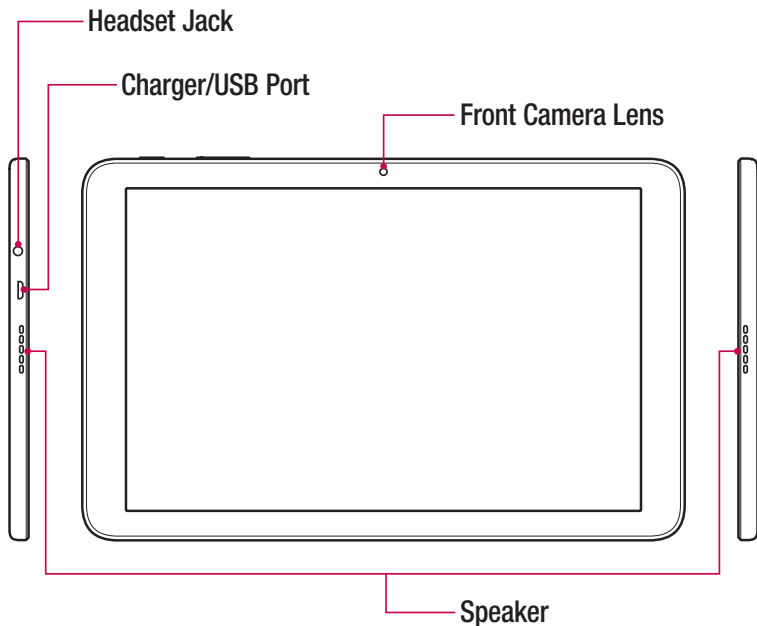

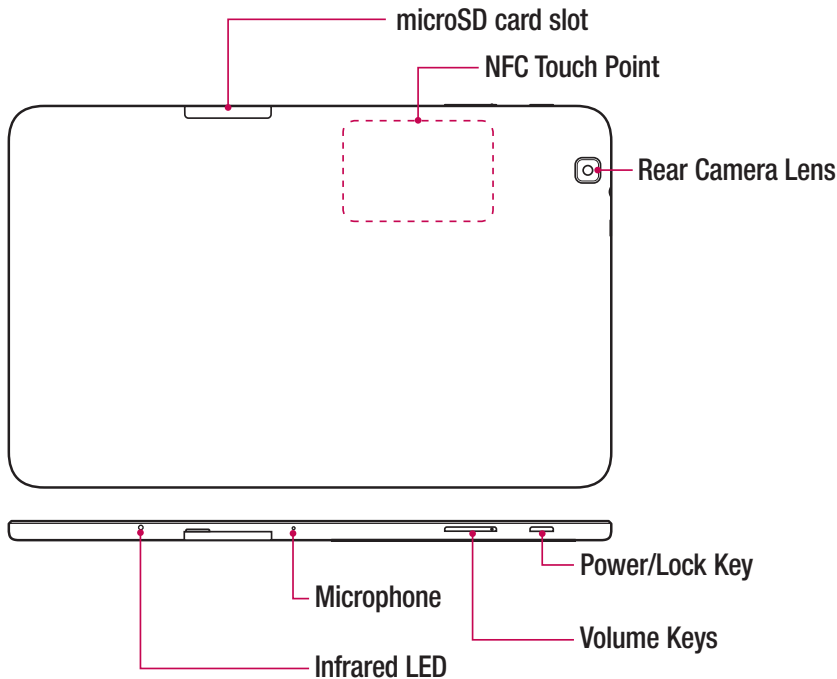

Power/Lock Key

- Press to lock/unlock the screen.
- Press and hold to turn the tablet on/off, restart it, and activate/deactivate airplane mode.

Volume Keys

- Press and hold both of the Volume Keys at the same time to access QuickMemo+ feature while the screen is unlocked.
- Press either of the Volume Keys twice to access Camera while the screen is off or locked.

Charging the battery

Charge the battery before using it for first time. Use the charger to charge the battery. A computer can also be used to charge the battery by connecting the device to it using the USB cable.

WARNING

- Use only LG-approved chargers, batteries and cables. If you use unapproved chargers, batteries or cables, it may cause battery charging delay. Or this can cause the battery to explode or damage the device, which is not covered by the warranty.

The charger connector is located at the left side of the device. Insert the charger and plug it into a power outlet.

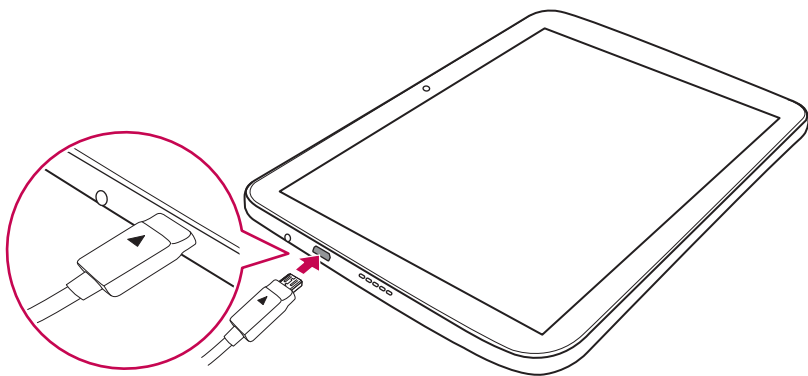

Installing the microSD card

Before you can start exploring your new device, you need to set it up. Your device supports the use of microSD memory cards of up to 2TB capacity. Multimedia contents can be saved in the microSD card.

- 1 Open the microSD card slot cover.

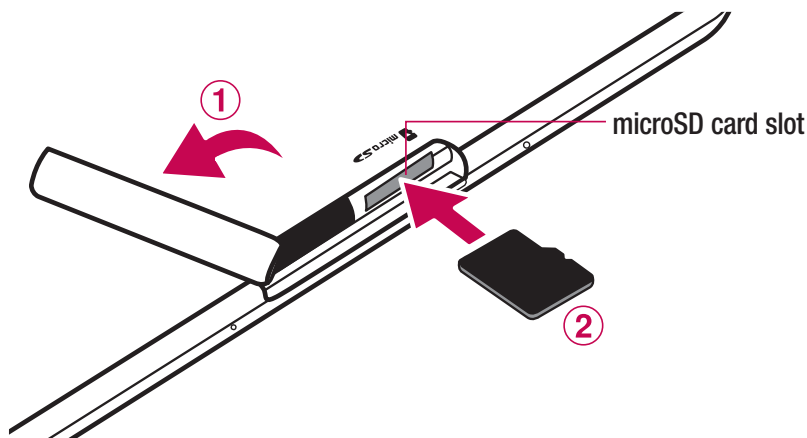



- 2 Insert the memory card into the microSD card slot. Make sure the gold contact area is facing downward. Slide the microSD card into the slot until it “clicks” into place and then close the slot cover.

NOTE

- Cards must be positioned as shown.
- MicroSD card is not included.
- Depending on the memory card manufacturer and type, some memory cards may not be compatible with your device.

Removing the memory card

Before removing the memory card, first unmount it for safe removal.

- 1 Tap  >  >  > **Storage** > **Unmount SD card**.
- 2 Open the card slot cover and press the memory card in to unlock it. Then pull it out of the slot.

WARNING

- Do not remove the memory card while the device is transferring or accessing information. Doing so can cause data to be lost or corrupted or damage to the memory card or device. LG is not responsible for losses that result from the misuse of damaged memory cards, including the loss of data.

Locking and unlocking the device

Pressing the **Power/Lock Key** turns off the screen and puts the device into lock mode. The device automatically gets locked if it is not used for a specified period. This helps to prevent accidental taps and saves battery power.



To unlock the device, press the **Power/Lock Key** and swipe the screen in any direction.

NOTE

- Double-tapping on the screen also can wake up the screen instead of the **Power/Lock Key**.

Changing the screen lock method

You can change the way that you lock the screen to prevent others accessing your personal information.

- 1 Tap  >  >  > **Display** > **Lock screen** > **Select screen lock**.
- 2 Select a desired screen lock from **None**, **Swipe**, **Knock Code**, **Pattern**, **PIN** and **Password**.



NOTE

- Create a Google account before setting an unlock pattern and remember the Backup PIN you created when creating your pattern lock.

TIP! Smart Lock

- You can use Smart Lock to make unlocking your device easier. You can set it to keep your device unlocked when you have a trusted Bluetooth device connected to it, when it's in a familiar location like your home, when it recognizes your face or voice or on-body detection.

Setting up Smart Lock

- 1 Tap  >  >  > **Display** > **Lock screen** > **Smart Lock**.
- 2 Before you add any trusted devices, trusted places, trusted face, trusted voice, or on-body detection, you need to set up a screen lock (pattern, PIN, or password).

Your Home screen

Touch screen tips

Here are some tips on how to navigate on your device.

- **Tap or touch** – A single finger tap selects items, links, shortcuts and letters on the on-screen keyboard.
- **Touch and hold** – Touch and hold an item on the screen by tapping it and not lifting your finger until an action occurs.
- **Drag** – Touch and hold an item for a moment and then, without lifting your finger, move your finger on the screen until you reach the target position. You can drag items on the Home screen to reposition them.
- **Swipe or slide** – To swipe or slide, quickly move your finger across the surface of the screen, without pausing when you first tap it (so you don't drag an item instead).
- **Double-tap** – Double-tap to zoom on a webpage or a map.
- **Pinch-to-Zoom** – Use your index finger and thumb in a pinching or spreading motion to zoom in or out when using the browser, Maps, or when viewing pictures.
- **Rotate the screen** – From many applications and menus, the screen orientation adjusts to the device's physical orientation.

NOTE

- Do not press too hard; the tap screen is sensitive enough to pick up a light, yet firm tap.
- Use the tip of your finger to tap the option you want. Be careful not to tap any other buttons.

Home screen

The Home screen is the starting point for many applications and functions. It allows you to add items like app shortcuts and Google widgets to give you instant access to information and applications. This is the default canvas and accessible from any menu by tapping .

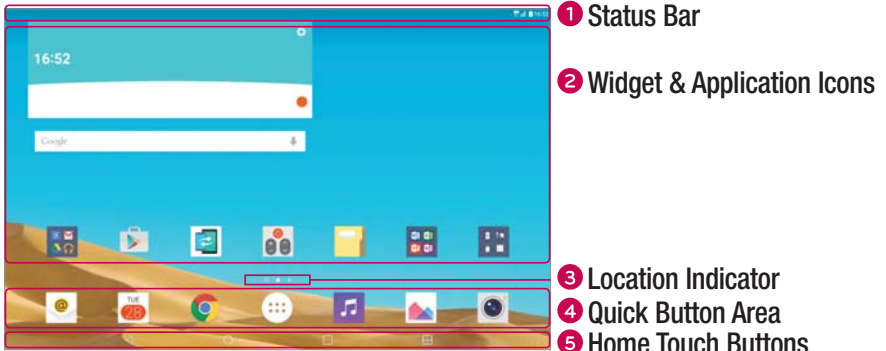

- 1 Shows the device's status information, including the time, signal strength, battery status and notification icons.
- 2 Widgets are self-contained applications that can be accessed through the Apps screen or on the Home screen. Unlike a shortcut, the Widget can function as an on-screen application. Tap an icon (application, folder, etc.) to open and use it.
- 3 Indicates which Home screen canvas you are currently viewing.
- 4 Provides one-touch access to the function from any Home screen canvas.

5 ◀ Back Button	Returns to the previous screen. Also closes pop-up items, such as menus, dialogue boxes and the on-screen keyboard.
○ Home Button	Return to the Home screen from any screen. Touch and hold to access the Google Now shortcut.
□ Recent Apps Button	Displays recently used applications. If you touch and hold this button, it opens a menu of available options.
☰ Dual window Button	Tap to change to dual window mode. It allows you to manage two different apps at the same time by splitting the screen in two.

Extended Home screen

The operating system provides multiple Home screen canvases to provide more space for adding icons, widgets and more.

- Slide your finger left or right across the Home screen to access additional canvases.

Customizing the Home screen

You can customize your Home screen by adding apps and widgets and changing wallpapers.

Adding items on your Home screen

- 1 Touch and hold the empty part of the Home screen.
- 2 Tap the **Apps** or **Widgets** tab and select the item you want to add. You then see this added item on the Home screen.
- 3 Drag it to the desired location and lift your finger.

TIP!

- To add an application icon to the Home screen from the Apps screen, touch and hold the application you want to add.

Removing an item from the Home screen

- While on the Home screen, touch and hold the icon you want to remove then drag it to  and release it.

Adding an app to the Quick Button area

- From the Apps screen or on the Home screen, touch and hold an application icon and drag it to the Quick Button area. Then release it in the desired location.

Removing an app from the Quick Button area

- Touch and hold the desired Quick Button, drag it to , and release it.

NOTE

- The **Apps Button**  cannot be removed.

Customizing app icons on the Home screen

- 1 Touch and hold an application icon until it unlocks from its current position, then release it. The editing icon  appears in the upper-right corner of the application.
- 2 Tap the application icon again and select the desired icon design and size.
- 3 Tap **OK** to save the change.

NOTE

- You can also tap **Add new** to personalize icons with your pictures.

Returning to recently-used applications

- 1 Tap . App previews of recently used applications will be displayed.
- 2 Tap an app preview to open the application. Or tap  to return to your previous screen.

Notifications panel

Notifications alert you to the arrival of new messages, calendar events and alarms, as well as ongoing events, such as downloads.

When a notification arrives, its icon appears at the top of the screen. Icons for pending notifications appear on the left, and system icons, such as Wi-Fi and battery strength are shown on the right.

NOTE

- The available options may vary depending on the region or service provider.

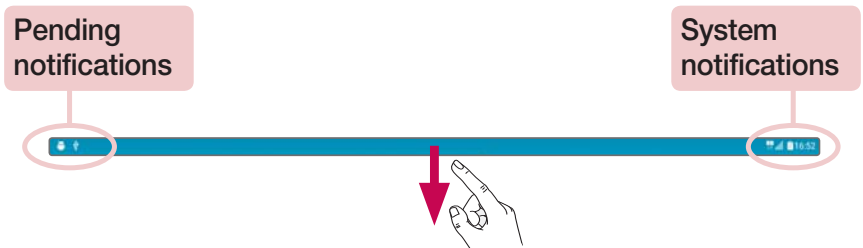

Opening the Notifications panel

Swipe the Status Bar down to open the notifications panel. To close the Notifications panel, swipe the screen upwards or tap .

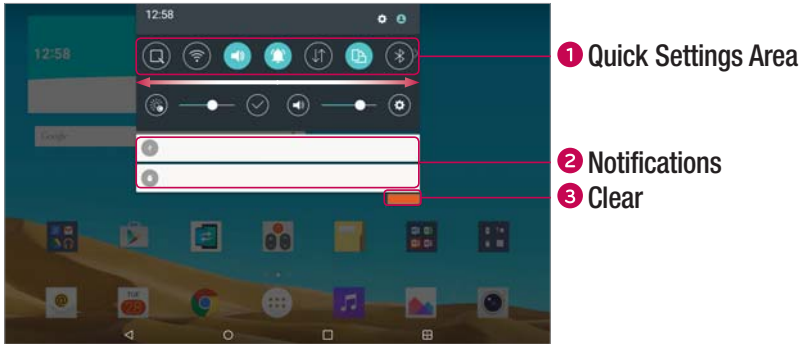





















- 1 Tap each quick setting button to toggle it on/off. Touch and hold the desired button to directly access the settings menu for the function. To see more toggle keys, swipe left or right. Tap  to remove, add or rearrange quick setting buttons.
- 2 Current notifications are listed, each with a brief description. Tap a notification to view it.
- 3 Tap to clear all of the notifications.

Indicator icons on the Status Bar

Indicator icons appear on the Status Bar at the top of the screen to calendar events, device status and more.



The icons displayed at the top of the screen provide information about the status of the device. The icons listed in the table below are some of the most common ones.

Icon	Description	Icon	Description
	No network signal available		A song is currently playing
	Airplane mode is on		No interruptions, not even alarms
	Connected to a Wi-Fi network		Vibrate mode is on
	Wired headset connected		Battery fully charged
	Bluetooth is on		Battery is charging
	System warning		The device is connected to a PC via a USB cable
	An alarm is set		Downloading data
	Data is synchronizing		Uploading data
	VPN is active		GPS is on
	Media server content sharing is on		Choose input method







NOTE

- The icon's location in the Status Bar may differ according to the function or service.

On-screen keyboard

You can enter text using the on-screen keyboard. The on-screen keyboard appears on the screen when you tap an available text entry field.

Using the keypad and entering text

-  Tap once to capitalize the next letter you type. Double-tap for all caps.
-  Tap to go to the keyboard settings. Touch and hold to enter text by voice, handwriting, or access the clip tray.
-  Tap to enter a space.
-  Tap to create a new line.
-  Tap to delete the previous character.
-  Tap to change the keyboard type. When the keyboard is undocked, drag this key to move the keyboard up or down.
 - **Dock/Undock** – Allows you to dock or undock the keyboard.

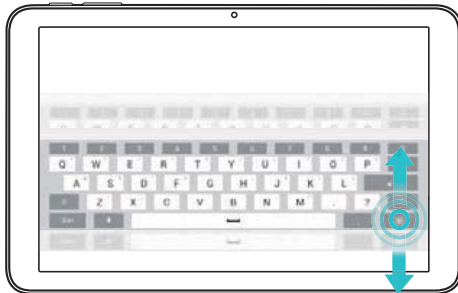

- **Split/Merge** – Allows you to split the keyboard for easier text entry with both hands. You can also spread two fingers across the keyboard to split it. Join two fingers across the keyboard to merge it.

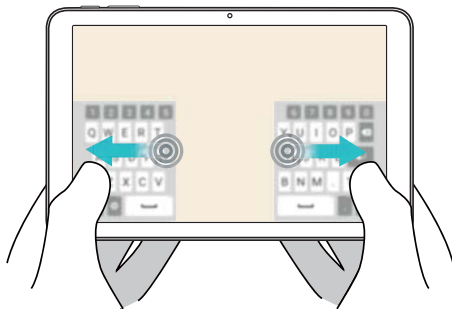

- **Floating** – Displays a small floating keyboard and allows you to move it around the screen.

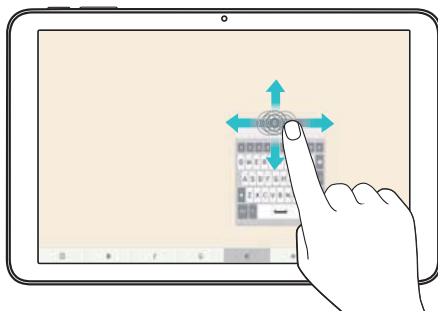

Entering special characters

The on-screen keyboard allows you to enter special characters.

For example, to input "á", touch and hold the "a" button until the pop-up appears and displays related special characters. Without lifting the finger, drag your finger to the desired special character. Once it's highlighted, lift your finger.

NOTE

- A symbol at the top right corner of a key indicates that additional characters are available for that key.

Special Features

Gesture shot

The Gesture shot feature allows you to take a picture with a hand gesture using the front camera.

To take a photo

There are two methods for using the Gesture shot feature.

- Raise your hand, with an open palm, until the front camera detects it and a box appears on the screen. Then close your hand into a fist to start the timer, allowing you time to get ready.
- OR -
- Raise your hand, in a clenched fist, until the front camera detects it and a box appears on the screen. Then unclench your fist to start the timer, allowing you time to get ready.

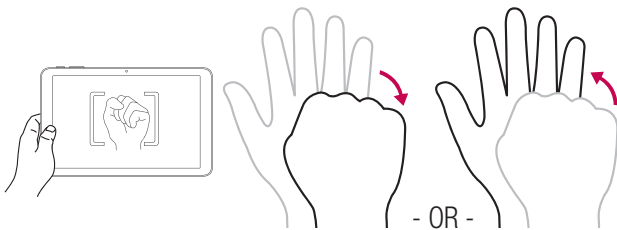

TIP! Interval shot

- If you make a fist twice or touch and hold , the camera takes multiple photos at a time.

KnockON

The KnockON feature allows you to double-tap the screen to easily turn it on or off.

To turn the screen on

- 1 Double-tap the center of the screen to turn the screen on.
- 2 Unlock the screen or access any of the available shortcuts or widgets.

To turn the screen off



- 1 Double-tap an empty area of the Home screen or the Status Bar.
- 2 The screen will turn off.

NOTE

- Make sure to tap on the center area of the screen. If you tap on the bottom or the top area, the recognition rate may decrease.

Knock Code

The Knock Code feature allows you to create your own unlock code using a combination of knocks on the screen. You can access the Home screen directly when the screen is off by tapping the same sequence on the screen.

- 1 Tap  >  >  > **Display** > **Lock screen** > **Select screen lock** > **Knock Code**.
- 2 Tap the squares in a pattern to set your Knock Code. Your Knock Code pattern can be 3 to 8 taps.

Unlocking the screen using the Knock Code

You can unlock the screen by tapping the Knock Code pattern you already set, when the screen turns off.

NOTE

- If you enter the wrong Knock Code 6 times, you will be required to enter your backup PIN.
- Use your fingertip instead of your fingernail to tap the screen.

Dual window





This feature allows you to multi-task by splitting up the screen into two, allowing you to use two compatible applications at the same time.

1 Tap  > **Dual window**.

OR

Tap .

2 Tap or drag the app icon for the corresponding application you wish to use.

	Tap to view the Dual window menu options, or drag to resize the split screens.
	Switch the two screens.
	View the app list.
	Change the selected window to full screen.
	Close the currently selected app window.

NOTE

- Dual window is enabled by default. You can enable or disable Dual window through the Settings menu.

1 Tap  >  >  > **Dual window**.

2 Slide the toggle button to **ON** or **OFF**.







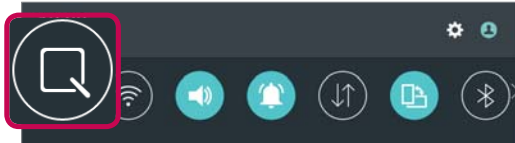

QuickMemo+

The QuickMemo+ feature allows you to create memos by capturing screen shots and drawing on them or entering text.

- 1 While viewing the screen you want to capture and use in your memo, drag the Status bar down and tap .



- 2 Create a memo using the following options:

	Tap to save the memo you've created.
	Tap to undo the most recent action.
	Tap to redo the most recently deleted action.
	Tap to insert text into your memo.
	Tap to select the pen type and color.
	Tap to crop the image as desired.
	Tap to hide or display the toolbar.
	Tap to access additional options.

NOTE

- Please use a fingertip while using the QuickMemo+ feature. Do not use your fingernail.

3 Tap  to save the current memo to the **QuickMemo+** or **Gallery**.

View the Saved Memo

Tap  >  >  and select the **QuickMemo+** album or tap  and select the desired memo.

Using the QuickMemo+ panel

The QuickMemo+ panel on the Home screen allows quick access to the QuickMemo+ app to easily create memos.







- 1 While on the Home screen, swipe to the right to access the QuickMemo+ panel.
- 2 Tap anywhere on the screen to create a memo.
- 3 Tap  to automatically save the current memo to the **QuickMemo+** app.

NOTE

- You can add or remove the QuickMemo+ panel as you wish.
 - Via the Settings menu.

If you don't want to see QuickMemo+ panel on the Home screen, you can disable it.

Tap  >  >  > **Display** > **Home screen** > disable the **QuickMemo+ panel** option.
- OR**
- Via the Home screen.

When you want to remove the QuickMemo+ panel from the Home screen, pinch in on the Home screen, touch and hold the QuickMemo+ panel, then drag it to  and release it. You can enable it on later by tapping  > **Display** > **Home screen** > enable the **QuickMemo+ panel** option.
- While using the QuickMemo+ app, use two fingers to scroll down and access more space for the memo.

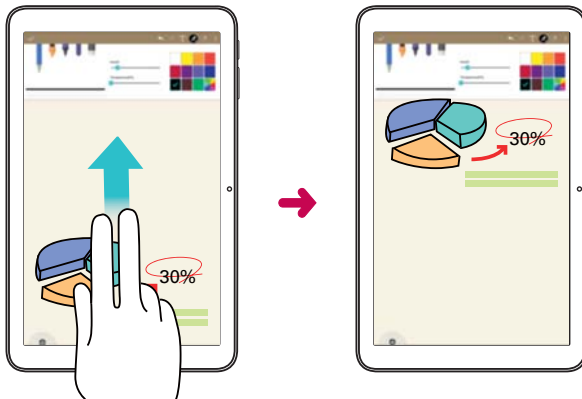

QSlide

From any screen, use the Notification panel to easily access and use the Notepad, Calendar, Calculator, and more with QSlide.

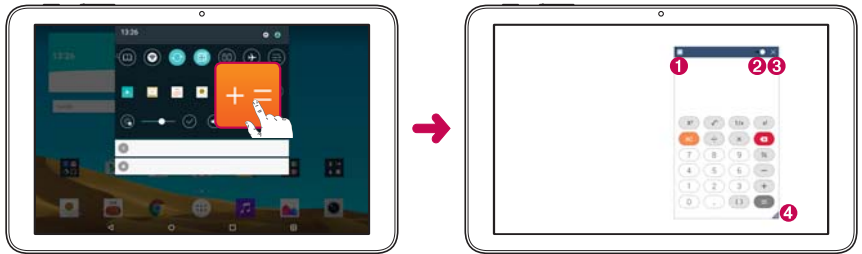

1		Tap to expand the window to full window size.
2		Tap to adjust the window's transparency.
3		Tap to close the QSlide window.
4		Drag to adjust the window size.

1 Slide the Status Bar downward, then tap **QSlide** to enable the QSlide Apps bar. Then tap the desired app from the QSlide Apps bar.

OR

While using applications that support QSlide, tap **☰ > QSlide**. The function is displayed as a small window on your screen.





2 To use the background screen while a **QSlide** window is overlapping it, slide the transparency bar to a transparent level.

NOTE

- QSlide can support up to two windows at the same time.

QuickRemote

QuickRemote turns your device into a universal remote for your home TV, audio system and more.

- 1 Slide the Status Bar downward and tap  > .
If you can not see , tap  > checkmark QuickRemote to enable.

OR

Tap  >  >  > .

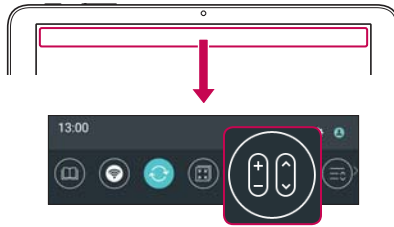

- 2 Select the type and brand of the device, then follow the on-screen instructions to configure the device.

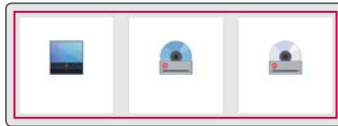

- 3 Once you have completed the initial set up, you can easily access the QuickRemote from the Notification panel. Open the Notification panel and use the QuickRemote functions.

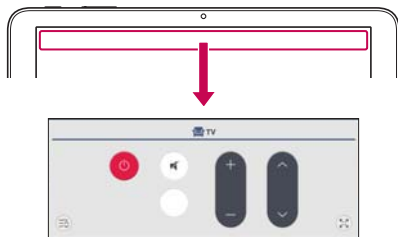



NOTE

- QuickRemote operates the same way as an ordinary remote control infrared (IR) signals. Be careful not to cover the infrared sensor at the top of the device when you use the QuickRemote function. This function may not be supported depending on the model, the manufacturer or service company.



Google Account Setup

The first time you open a Google application on your device, you will be required to sign in with your existing Google account. If you do not have a Google account, you will be prompted to create one.

Creating your Google account

- 1 Tap  > .
- 2 Tap  > **Accounts & sync** > **Add account** > **Google** > **Or create a new account**.
- 3 Enter your first and last name, then tap **NEXT**.
- 4 Enter a username and tap **NEXT**. Your device will communicate with Google servers and check for username availability.
- 5 Enter your password and tap **NEXT**.
- 6 Follow the instructions and enter the required and optional information about the account. Wait while the server creates your account.

Signing into your Google account

- 1 Tap  > .
- 2 Tap  > **Accounts & sync** > **Add account** > **Google**.
- 3 Enter your email address and tap **NEXT**.
- 4 Follow the instructions on the screen.

After signing in, your device will sync with your Google services, such as Gmail, Contacts, and Google Calendar. You can also use Maps, download applications from Play Store, back up your settings to Google servers, and take advantage of other Google services on your device.

IMPORTANT





- Some applications, such as Calendar, work only with the first Google Account you add. If you plan to use more than one Google Account with your device, be sure to sign into the one you want to use with such applications first. When you sign in, your contacts, Gmail messages, Calendar events, and other information from these applications and services on the web are synchronized with your device. If you don't sign into a Google Account during setup, you will be prompted to sign in or to create a Google Account the first time you start an application that requires one, such as Gmail or Play Store.
- If you have an enterprise account through your company or other organization, your IT department may have special instructions on how to sign into that account.

Connecting to Networks and Devices

Wi-Fi

You can use high-speed Internet access while within the coverage of the wireless access point (AP).





Connecting to Wi-Fi networks

- 1 Tap  >  >  > **Wi-Fi**.
- 2 Tap  to turn Wi-Fi on and start scanning for available Wi-Fi networks.
- 3 Tap a network to connect to it.
 - If the network is secured with a lock icon, you will need to enter a security key or password.
- 4 The Status Bar displays icons that indicate Wi-Fi status.

NOTE

- If you are out of the Wi-Fi zone or have set Wi-Fi to Off, the device may automatically connect to the Web using mobile data, which may incur data charges.

TIP! How to obtain the MAC address

- Tap  >  >  > **Wi-Fi** >  > **Advanced Wi-Fi** > **MAC address**.





Bluetooth

Bluetooth is a short-range communications technology that allows you to connect wirelessly to a number of Bluetooth devices, such as headsets and hands-free car kits, and Bluetooth-enabled handhelds, computers, printers, and wireless devices.

NOTE

- LG is not responsible for the loss, interception or misuse of data sent or received via the Bluetooth feature.
- Always make sure that you share and receive data with devices that are trusted and properly secured.
- If there are obstacles between the devices, the operating distance may be reduced.
- Some devices, especially those that are not tested or approved by Bluetooth SIG, may be incompatible with your device.

Pairing your device with another Bluetooth device

- 1 Tap  >  >  > **Bluetooth**.
- 2 Tap  to turn Bluetooth on and start scanning for available Bluetooth devices.
 - If you want to detect the visible devices in range additionally, tap **SEARCH**.
- 3 Choose the device you want to pair with from the list. Once the pairing is successful, your device connects to the other device.

NOTE

- Pairing between two Bluetooth devices is a one-time process. Once a pairing has been created, the devices will continue to recognize their partnership and exchange information.

TIP!

- Please consult the documentation included with the Bluetooth device for information on pairing mode and passcode (typically 0 0 0 0 – four zeroes).





Sending data via Bluetooth

- 1 Select a file or item such as a contact or media file.
- 2 Select the option for sending data via Bluetooth.
- 3 Search for and pair with a Bluetooth-enabled device.

NOTE

- Due to different specifications and features of other Bluetooth-compatible devices, display and operations may be different, and functions such as transfer or exchange may not be possible with all Bluetooth compatible devices.

Receiving data via Bluetooth

- 1 Tap  >  >  > **Bluetooth**.
- 2 Tap  to turn Bluetooth on.
- 3 You will receive a request to accept data from the sending device. Be sure to select **ACCEPT**.

Wi-Fi Direct

Wi-Fi Direct provides a direct connection between Wi-Fi enabled devices without requiring an access point.

Turning on Wi-Fi Direct

- 1 Tap  >  >  > **Wi-Fi**.
- 2 Tap  > **Advanced Wi-Fi** > **Wi-Fi Direct**.

NOTE

- When in this menu, your device is visible to other visible Wi-Fi Direct devices nearby.

SmartShare

SmartShare allows you to receive multimedia content via LG device and tablets.

- 1 While viewing the content you want to share, tap  or  > **SmartShare**.
 - SmartShare Beam quickly transfers multimedia contents through Wi-Fi Direct.
- 2 Tap the device you want to share from the list.
 - If the device is not displayed on the list, make sure that Wi-Fi, Wi-Fi Direct, or Bluetooth is turned on. Then tap **RESCAN**.

Enjoying content from nearby devices

- 1 To connect nearby devices to your device, tap the **Nearby devices** option on the **Gallery** and **Music** apps.
 - Make sure that your device and nearby devices are connected to the same Wi-Fi network and that the DLNA service on the nearby device is turned on.
- 2 Tap the device you wish to connect to.
If the device is not listed, tap **Search nearby devices**.
- 3 After a connection is established, you can enjoy the content on your device.

QPair

By connecting your tablet and mobile device via QPair, you can sync incoming calls, messages, and social networking notifications between your tablet and mobile device.



1 Tap **O** > **⋮** > **📱**.

2 Tap **GET STARTED** > **Start** on your tablet first and then run the same steps on your device.

TIP!

- QPair may not be pre-installed on the device. Go to the Google Play Store and search for QPair and install it.

NOTE

- QPair works with devices running Android 4.1 or later. Some features may be limited depending on your device model.
- Since QPair uses the Bluetooth function, it may not work normally if you change the Bluetooth settings while QPair is in use.

3 Bluetooth connection will be turned on and you will be able to pair the devices.

QPair features

Call notifications – Sends the tablet a notification when the device receives a call. The notification displays the caller's number and allows you to answer and decline the call. You can also change call settings, such as a ringtone, ringtone volume, ringtone with vibration, or send a decline message when you get a call.

NOTE

- You can only receive a call supported by Bluetooth technology. Dialing a call from the tablet using the QPair feature is not possible.

Message notifications – Sends the tablet a notification when the device receives a message. You can also change message settings, such as message pop-up, message preview, notification sound, and notification vibration.

Social network notifications – Displays a social networking notification on your tablet's Status Bar when it arrives on your device.

NOTE

- To enable this feature, turn the **QPair social network notifications** option on the phone (**Settings > Accessibility > QPair social network notifications**). This option allows you to be notified of social networking notifications on your tablet.

QuickMemo+ transfer – Saves your current QuickMemo+ in the tablet's Gallery to the Gallery on your phone.

Internet via phone – Connection will be established through Internet via phone (Wi-Fi hotspot). Phone data charges may apply.

Transferring data between a PC and your device

You can copy or move data between a PC and the device.

Transferring data

- 1 Connect your device to a PC using the USB cable that came with your device.
- 2 Open the Notifications panel, tap the current USB connection, and select **Media device (MTP)**.
- 3 A window will pop-up on your PC, allowing you to transfer the desired data.

NOTE

- The LG United Mobile Driver is required to be installed on your PC to be able to detect the device.
- Check the requirements for using **Media device (MTP)**.



Items	Requirement
OS	Microsoft Windows XP SP3, Vista or higher
Window Media Player version	Windows Media Player 10 or higher

- Please refer to www.android.com/filetransfer/#tips in order to use MTP on the MAC OS.





Contacts

You can add contacts on your device and synchronize them with the contacts in your Google Account or other accounts that support syncing contacts.

Searching for a contact

- 1 Tap  >  >  to open your contacts.
- 2 Tap **Search contacts** and enter the contact name using the keyboard.



Adding a new contact

- 1 Tap  >  >  > .
- 2 Select the desired account (if applicable).
- 3 If you want to add a picture to the new contact, tap the image area.
Choose **Take photo** or **Select from Gallery**.
- 4 Enter the desired information for the contact.
- 5 Tap **SAVE**.



Favorite contacts

You can classify frequently used contacts as favorites.



Adding a contact to your favorites

- 1 Tap  >  >  to open your contacts.
- 2 Tap a contact to view its details.
- 3 Tap the star at the top right of the contact details screen. The star turns gold.

Removing a contact from your favorites list

- 1 Tap  >  >  to open your contacts.
- 2 Tap the **Favorites** tab and choose a contact to view its details.
- 3 Tap the gold star at the top right of the contact details screen. The star turns a dark color and the contact is removed from your favorites.

Creating a group

- 1 Tap  to open your contacts.
- 2 Tap **Groups** > .
- 3 Enter a name for the new group.
- 4 Tap **Add members** to add contacts to the group.
- 5 Select the desired contacts and tap **ADD**.
- 6 Tap **SAVE** to save the group.

NOTE



- If you delete a group, the contacts assigned to that group will not be lost. They will remain in your contact list.

E-mail

You can use the Email application to read email from providers other than Gmail.

Setting up email accounts



The first time you open the Email application, a setup wizard opens to help you add an email account.

- 1 Tap  >  > .
- 2 Select the desired provider.
- 3 Enter your email address and password, then tap **NEXT**.
- 4 Follow the on-screen instructions to complete the setup.

NOTE

- To add another email account, tap  > **Settings** > **Add account**.
- To change the email general settings, tap  > **Settings** > **General settings**.
- To delete an email account, tap  > **Settings** >  > **Remove account** > Select the account you want to delete > **REMOVE** > **YES**.



Composing and sending email

- 1 Tap the email account to use, then tap  to create a new email.
- 2 Enter an address for the message's intended recipient. As you enter text, matching addresses will be offered from your contacts. Separate multiple addresses with semicolons.
- 3 Tap the **Cc/Bcc** field to copy or blind copy to other contacts/email addresses.
- 4 Tap the text field and enter your message.
- 5 Tap  to attach the file you want to send with your message.
- 6 Tap  to send the message.







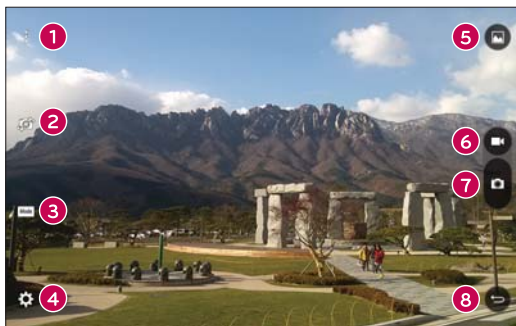

Camera and Video

Camera options on the viewfinder

You can use the camera or camcorder to take and share pictures and videos.

- Tap  >  > .



1 	Tap to hide/display the camera options on the viewfinder.
2 	Tap to swap between the rear camera lens and the front camera lens.
3 	Allows you to select the shot mode for the picture.
4 	Tap this icon to open the camera settings menu.
5 	Tap to view the last photo or video you captured.
6 	Tap to start recording.
7 	Tap to take a photo.
8 	Tap to exit the camera.

NOTE





- Be sure to clean the protective lens cover with a microfiber cloth before taking pictures. A lens cover with smudges from fingers can cause blurry pictures with a "halo" effect.

Using the advanced settings

In the camera viewfinder, tap  to show the advanced options. Tap each icon to adjust the following camera settings.

	Combines photos taken at multiple exposures into one optimal photo to get a better photo in difficult lighting situations.
	Set the size of your picture and video.
	Allows you to say a voice command to take pictures. You can say LG , Cheese , Smile , or any other supported command.
	Set your camera's timer. This is ideal if you want to be a part of the picture or video.
	Allows you to take better pictures and record better videos by displaying a grid line for help with alignment.
	Set the storage location for your pictures and videos. This menu appears only when the SD card is inserted.
	Allows you to learn how a function works. This icon will provide you with a help guide.

Taking a photo

- 1 Tap  >  > .
- 2 Frame your subject on the screen.
- 3 A square around the subject indicates that the camera has focused.
- 4 Tap  to take a photo. Your picture will be automatically saved to the Gallery.

Multi-point Auto Focus





When you take a picture, the Multi-point Auto Focus (AF) function operates automatically and allows you to see a clear image.

Burst shot

Allows you to take multiple shots quickly. Touch and hold .

Once you have taken a photo

Tap the image thumbnail on the screen to view the last photo you took. The following options are available.

	Tap to add the photo to your favorites.
	Tap to edit the photo.
	Tap to take another photo immediately.
	Tap to open the available sharing options.
	Tap to delete the photo.
	Tap to access additional options.

Recording a video

1 Open the  application and point the lens toward the subject you want to capture in your video.

2 Tap  once to start recording.

NOTE

- The timer will be displayed on the screen.

3 Tap  to stop recording.

NOTE

-  – Tap to pause the recording.

Live Shot

Allows you to capture a screen shot while recording a video. Tap .

Live Zoom

Live Zoom allows you to zoom in or out on a portion of a video that is being played to make the desired section appear larger or smaller.

When viewing a video, use your index finger and thumb in a pinching or spreading motion to zoom in or out.



NOTE

- Do not press too hard; the touch screen is sensitive enough to pick up a light, but firm touch.

Dual Play

Dual Play connects two devices using a wired (Slimport-HDMI) cable or wireless (Miracast) connection, allowing you to view content on a different screen.





The connectable device can be a TV or a monitor. Viewable content can come from the Gallery and Video apps, however not all videos are supported by Dual Play.

NOTE

- Tap  once when two displays are a different status (i.e. the monitor is playing a video and your device's video app is displaying an empty screen), then Dual Play will start.



After recording a video

Tap the video thumbnail on the screen to view the last video you recorded. The following options are available.

	Tap to add the video to favorites.
	Tap to record another video immediately.
	Tap to send your video to others or share it via any available social network services.
	Tap to delete the video.
	Tap to access additional options.

Gallery

The Gallery application presents the pictures and videos in your storage, including those you've taken with the Camera application and those you downloaded from the web or other locations.

- 1 Tap  >  >  to view the images stored in the storage.
- 2 Tap an album to open it and view its contents. (The pictures and videos in the album are displayed in chronological order.)
- 3 Tap a picture in an album to view it.

NOTE

- Depending on the software installed, some file formats may not be supported.
- Some files may not play properly due to their encoding.

Viewing pictures

The Gallery displays your pictures in folders. When some apps save a picture, a folder is automatically created to contain the picture.

Pictures are displayed by the date they were created. Select a picture to view it full screen. Scroll left or right to view the next or previous image.

Timeline view

The Gallery automatically sorts and displays a lot of photos in chronological order to see at a glance.

- 1 Tap  >  > .
- 2 Tap  > **Timeline**.

Memories view

The Gallery automatically organizes and displays the memories albums depending on the region and time information of the saved photos.

- 1 Tap  >  > .
- 2 Tap  > **Memories**.
- 3 Select the desired albums.

NOTE



- This feature is a location based service. Make sure to enable location information for photos and videos for this feature to function properly.

Zooming in and out







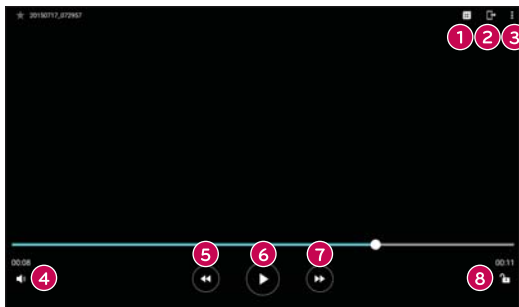

Use one of the following methods to zoom in and out on an image:

- Double-tap anywhere to zoom in and out.
- Spread two fingers apart on any place in the picture zoom in. Pinch in to zoom out.

Video options

- 1 Tap  >  > .
- 2 Select the video you want to watch.



1		Tap to use QSlide for the Video app.
2		Tap to share your video using the SmartShare function.
3		Tap to access additional options.
4		Tap to adjust video volume.
5		Touch and hold to rewind in 3 second increments. Tap to rewind 10 seconds.
6		Tap to pause/resume video playback.
7		Touch and hold to fast-forward in 3 second increments. Tap to fast-forward 10 seconds.
8		Touch to lock/unlock the screen.

NOTE



- While playing a video, the following options are available:
 - Slide the right side of the screen up or down to adjust the sound.
 - Slide the left side of the screen up or down to adjust the brightness.
 - Slide your finger from left to right (or vice versa) to fast-forward and rewind.

Editing photos

While viewing a photo, tap .

Deleting photos/videos

Use one of the following methods:

- While in a folder, tap , select the photos/videos you want to delete. Then tap **DELETE**.
- While viewing a photo, tap .

Setting wallpaper

While viewing a photo, tap  > **Set image as** to set the image as wallpaper or assign it to a contact.

NOTE



- Depending on the software installed, some file formats may not be supported.
- If the file size exceeds the available memory, an error can occur when you open files.

Multimedia





Music



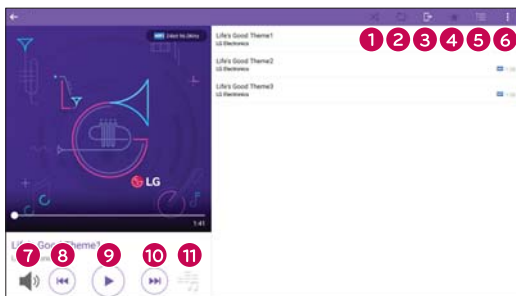



Your device has a music player that lets you play all your favorite tracks.

Playing a song

- 1 Tap  >  > .
- 2 Tap the **Songs** tab.
- 3 Select the song you want to play.
- 4 The following options are available.



- | | |
|---|---|
|  | Tap to play the current playlist in shuffle mode (tracks are played in random order). |
|  | Tap to toggle through repeat all songs, repeat current song and repeat off. |
|  | Tap to share your music via the SmartShare function. |
|  | Tap to add the song to your favorites. |
|  | Tap to open the current playlist. |

	Tap to access additional options.
	Tap to adjust the volume.
	Tap to restart the current track or skip to the previous track in the album, playlist or shuffle list. Touch and hold to rewind.
	Tap to pause playback.
	Tap to resume playback.
	Tap to skip to the next track in the album, playlist or shuffle list. Touch and hold to fast-forward.
	Tap to set audio effects.



NOTE

- Depending on the software installed, some file formats may not be supported.
- If the file size exceeds the available memory, an error can occur when you open files.
- Music file copyrights may be protected by international treaties and national copyright laws. Therefore, it may be necessary to obtain permission or a license to reproduce or copy music. In some countries, national laws prohibit private copying of copyrighted material. Before downloading or copying the file, please check the national laws of the relevant country concerning the use of such material.

Utilities

Clock

The Clock app gives you access to the Alarms, Timer, World clock and Stopwatch functions. Access these functions by tapping the tabs across the top of the screen or swiping horizontally across the screen.

- Tap  >  > .

Alarms

The Alarms tab allows you to set alarms.

- 1 Tap  >  >  > **Alarms** tab.
- 2 Tap  to add a new alarm.
- 3 Adjust the settings as necessary and tap **SAVE**.

NOTE

- You can also tap an existing alarm to edit it.

Timer

The Timer tab can alert you with an audible signal when a set amount of time has passed.

- 1 Tap  >  >  > **Timer** tab.
- 2 Set the desired time on the timer.
- 3 Tap **Start** to start the timer.
- 4 Tap **Stop** to stop the timer.

World clock

The World clock tab allows you to easily check the current time in other cities around the world.

- 1 Tap  >  >  > **World clock** tab.
- 2 Tap  and select the desired city.





Stopwatch

The Stopwatch tab allows you to use your device as a stopwatch.

- 1 Tap  >  >  > **Stopwatch** tab.
- 2 Tap **Start** to initiate the stopwatch.
 - Tap **Lap** to record lap times.
- 3 Tap **Stop** to stop stopwatch.

Calculator

The Calculator app allows you to perform mathematical calculations using a standard or scientific calculator.

- 1 Tap  >  > .
- 2 Tap the number buttons to enter numbers.
- 3 For simple calculations, tap the function you want to perform (+, -, x or ÷) followed by =.
- 4 For more complex calculations, tap  > **Scientific calculator**.

NOTE

- The Scientific calculator is enabled by default when the device is in landscape mode.

Calendar



The Calendar app allows you to track your schedule of events.

- 1 Tap  >  > .
- 2 Tap the date you want to add an event to. Then tap .

Voice Recorder

The Voice Recorder app records audible files for you to use in a variety of ways.

Recording a sound or voice



- 1 Tap  >  > .
- 2 Tap  to begin recording.
- 3 Tap  to end the recording.
- 4 Tap  to listen to the recording.

NOTE

- Tap  to access your recordings. You can listen to your saved recordings.

Voice Search

Use this application to search webpages using voice.



- 1 Tap  >  > **Google** folder > .
- 2 Say a keyword or phrase when **Listening...** appears on the screen. Select one of the suggested keywords that appear.

NOTE

- This application may not be available depending on the region or service provider.

Downloads

Use this application to see what files have been downloaded through the applications.

- Tap  >  > .



NOTE

- This application may not be available depending on the region or service provider.

LG SmartWorld

LG SmartWorld offers an assortment of exciting content – fonts, themes, games, applications.

How to Get to LG SmartWorld from Your Device

1 Tap  >  > .

2 Browse and download the content you want.

NOTE

- You may incur data fee charges when using your mobile network to access LG SmartWorld.
- LG SmartWorld may not be available for all carriers or in all countries.

What if there is no LG SmartWorld icon?

1 Using a mobile Web browser on your device, access LG SmartWorld (www.lgworld.com) and select your country.

2 Download the LG SmartWorld App.

3 Run and install the downloaded file.

4 Access LG SmartWorld by tapping the  icon.

Special benefits available for LG SmartWorld

- Personalize your device with home themes, keyboard themes, and fonts.
- Enjoy special promotions only offered on LG SmartWorld.
- Note that LG SmartWorld is only available for certain devices. Please check the www.lgworld.com for more information.

Browsing the Web

Chrome

Use Chrome to search for information and browse webpages.

1 Tap  >  > **Google** folder > .

NOTE

- This application may not be available depending on your region and service provider.

Viewing webpages

Tap the address field, and then enter a web address or search criteria.

Opening a page

To open a new page, tap  > **New tab**.

To go to another web page, tap a tab at the top of the screen to select the page.

Settings

The Settings application contains most of the tools for customizing and configuring your device. All of the settings in the Settings application are described in this section.

To open the Settings application

- Tap  > touch and hold  > **System settings**.
- OR -
- Tap  >  > .

WIRELESS NETWORKS

< Airplane mode >

Airplane Mode (flight mode) allows you to use many of your device's features, such as games, and music, when you are in an area where data use is prohibited. When you set your device to Airplane Mode, it cannot access online data.

< Wi-Fi >

Turns on Wi-Fi to connect to available Wi-Fi networks.

< Bluetooth >

Turns the Bluetooth wireless feature on or off to use Bluetooth.

< Data usage >

Displays the data usage and allows you to set a personalized mobile data usage limit.

< More... >

Miracast

You can mirror your tablet screen and sound onto a Miracast dongle or TV wirelessly.

SmartShare Beam

Allows you to receive multimedia content from LG devices or tablets.

LG Bridge

Allows you to connect to a computer to manage your device.

Media server

Share media content with nearby DLNA-compatible devices.

NFC

Allows you to send or receive files simply by bringing your phone and another data-compatible device together (typically within 20 mm of each other) at the NFC touchpoint. NFC (Near Field Communication) establishes radio communication between smartphones and similar devices.

VPN

From your device, you can add, set up, and manage virtual private networks (VPNs) that allow you to connect and access resources inside a secured local network, such as your corporate network.

Printing

Allows you to print the content of certain screens (such as web pages displayed in Chrome) to a printer connected to the same Wi-Fi network as your Android device.

DEVICE

< Sound & notification >

Sound profile

Allows you to set the sound profile to **Sound** and **Vibrate only**.

Volume

Adjust the device's volume settings to suit your needs and environment.

Notification sound

Select the ringtone for notifications, such as new messages received or calendar events.

Interruptions

Allows you to set a schedule when to prevent interruptions from notifications. You can set to allow certain features to interrupt when Priority only is set.

Lock screen

Allows you to choose if you want to show or hide notifications on the lock screen.

Apps

Allows you to prevent apps from displaying notifications or set apps to show notifications with priority when Interruptions is set to Priority only.

Touch sound

Allows you to set your tablet to play a sound when you touch buttons, icons and other onscreen items that react to your touch.

Screen lock sound

Allows you to set your tablet to play a sound when locking and unlocking the screen.

Vibrate on tap

Enable to vibrate when tapping the Home touch buttons and during other UI interactions.

< Display >

Home screen

- **QuickMemo+ panel** – Allows you to include an additional Home screen panel for writing a memo using QuickMemo+.
- **Theme** – Sets the screen theme for your device. You can download new themes from LG SmartWorld.
- **Wallpaper** – Allows you to set the desired wallpaper for your Home screen.
- **Screen swipe effect** – Choose the desired type of effect to display when you swipe from one Home screen canvas to the next.
- **Allow Home screen looping** – Enable to allow continuous Home screen scrolling (loop back to first screen after last screen).
- **Help** – Displays help information for the Home screen.

Lock screen

- **Select screen lock** – Allows you to set a screen lock to secure your device.
- **Smart Lock** – Sets to keep your device unlocked when you have a trusted Bluetooth device connected to it, when it's in a familiar location like your home, when it recognizes your face or voice or on-body detection.
- **Screen swipe effect** – Sets the effect used when swiping the lock screen.
- **Wallpaper** – Select the wallpaper to display for your lock screen.
- **Shortcuts** – Customize shortcuts on the lock screen.
- **Weather animation** – Enable to show weather animations on the lock screen for the current location.
- **Contact info for lost tablet** – Allows you to display the tablet owner information on the lock screen and customize the owner information.
- **Lock timer** – Allows you to set the amount of time before the screen automatically locks after the screen has timed-out.
- **Power button instantly locks** – Enable to instantly lock the screen when the Power/Lock Key is pressed.

Font type

Select the desired font type.

Font size

Select the desired font size.

Brightness

Allows you to adjust the screen brightness.

Auto-rotate screen

Allows you to set to switch the screen orientation automatically when you physically rotate the device.

Screen timeout

Allows you to set the amount of time before the screen times out.

Home touch buttons

Allows you to set which Home touch buttons are displayed and their position on the bar. You can also select the color and the background.

Reader mode

Allows you to reduce amount of blue light on the screen to reduce eye strain.

Daydream

Select the screensaver to display when the device is sleeping while docked and/or charging.

Motion sensor calibration

Allows you to improve the accuracy of the tilt and speed of the sensor.

< Storage >

Internal Storage

Allows you to view information about the internal storage usage.

SD Card

Allows you to view information about storage use on the SD card. Tap **Unmount SD** card to allow safe removal of the card. If no SD card is mounted but you have inserted it, tap **Mount SD card**. Tap **Erase SD card** if you want to delete all of the data from the SD card.

< Battery & power saving >

Battery information

The Battery charge information is displayed on a battery graphic along with the percentage of the remaining charge and its status.

Battery usage

Displays the battery usage level and battery use details. Tap one of the items to see more detailed information.

Battery percentage on status bar

Enable to display the battery level percentage on the Status Bar next to the battery icon.

Battery saver

Tap the Battery Saver switch  to toggle it On or Off. You can also set when to turn battery saver on and if you would like to restrict apps from running in the background.

Help

Displays help information for the Battery saver feature.

< Smart cleaning >

Allows you to manage unused apps and data.

< Apps >

Display the list of applications such as currently running or downloaded. Swipe left and right to view one of the three tabs across the top of the screen to view detailed information for **DOWNLOADED**, **ON SD CARD**, **RUNNING**, and **ALL** applications. Tap an entry to view more information, tap **Force stop** (or **Stop**), then **OK** to stop it from running.

< Dual window >

Auto-open

Allows the device to automatically open Dual window when you tap a link on the screen or tap an e-mail attachment (images only).

Help

Displays help information about using the Dual window feature.

PERSONAL

< Cloud >

Allows you to add a cloud account to quickly and easily use a cloud service.

< Users >

This menu displays the current users you've created.

Add user

Allows you to add and configure a new user for the device.

< Location >

By turning on the location service, your device determines your approximate location using Wi-Fi and mobile networks. When you select this option, you're asked whether you consent to allowing Google to use your location when providing these services.

- **Mode** – Sets the how your current location information is determined.
- **Recent Location Request** – Displays applications and services that have recently requested your location.
- **Camera** – Enable to tag photos or videos with their locations.
- **Google Location History** – Allows you to view and manage your Google location history.

< Security >

Use the Security menu to configure how to help secure your device and its data.

Content lock

Allows you to lock files for the Gallery and memos for QuickMemo+. You must set a password or pattern prior to enabling this option.

Encrypt tablet

Allows you to encrypt data on the device for security. You will be required to enter a PIN or password to decrypt your device each time you power it on.

Encrypt SD card storage

Encrypt SD card storage and keep data unavailable for other devices.

Password typing visible

Enable to briefly show each character of passwords as you enter them so that you can see what you enter.

Tablet administrators

View or deactivate device administrators.

Unknown sources

Allow installation of non-Play Store applications.

Verify apps

Disallow or warn before installation of apps that may cause harm.

Storage type

Displays the storage type for credentials.

Certificate management

Allows you to display trusted CA certificates, install certificates from storage, and remove all certificates.

Trust agents

Select apps to use without unlocking the screen.

Screen pin

This feature allows you to lock your device so that the current user can only access the pinned app. This is useful for users with children.

App usage access

Allows apps to view usage info of apps on your device.

< Accounts & sync >

Use the Accounts & sync settings menu to add, remove, and manage your Google and other supported accounts. You can also use these settings to control how and whether all applications send, receive, and sync data on their own schedules and whether all applications can synchronize user data automatically.

Gmail™, Calendar, and other applications may also have their own settings to control how they synchronize data; see the sections on those applications for details. Touch

Add account to add new account.

< Language & keyboard >

Use the Language & keyboard settings to select the language for the text on your device and to configure the on-screen keyboard.

< Backup & reset >

Change the settings for managing your settings and data.

LG Backup

Backs up all information on the device and restores it in the event of data loss or replacement.

Back up my data

Back up app data, Wi-Fi passwords, and other settings to Google servers.

Backup account

Displays the account that is currently being used to back up information

Automatic restore

When reinstalling an app, restore backed up settings and data.

Factory data reset

Reset your settings to the factory default values and delete all your data. If you reset the device this way, you are prompted to re-enter the same information as when you first started Android.

SYSTEM

< Shortcut key >

Allows you to turn the Shortcut keys on and off. Press and hold the Volume Up and Down keys together when the screen is unlocked to access QuickMemo+. Press either Volume key twice when the screen is off or locked to access the camera.

< Date & time >

Use Date & time settings to set how dates will be displayed. You can also use these settings to set your own time and time zone rather than obtaining the current time from the mobile network.

< Accessibility >

Use the Accessibility settings to configure accessibility plug-ins you have installed on your device.

Vision

- **TalkBack** – Allows you to set up the TalkBack function, which assists people with impaired vision by providing verbal feedback. Tap  to toggle it On or Off.
- **Screen shade** – Enable to dim the screen's backlight for a darker contrast.
- **Font size** – Allows you to change the font size.
- **Touch zoom** – Allows you to triple-tap the screen to zoom in and out.
- **Screen color inversion** – Enable to invert the colors of the screen and content.
- **Screen color adjustment** – Allows you to view the screen with greater color contrast. To adjust the contrast and hue, activate the feature and drag your finger across the screen.
- **Screen color filter** – Allows you to change the colors of the screen and its content.

Hearing

- **Captions** – Allows you to customize caption settings for those with hearing impairments.
- **Turn off all sounds** – Enable to turn off all device sounds.
- **Audio type** – Sets the audio type.
- **Sound balance** – Sets the audio route. Move the slider on the slide bar to set it as desired.

Motor & cognition

- **Touch feedback time** – Sets the touch feedback time.
- **Touch assistant** – Show a touch board with easy access to common actions.
- **Screen timeout** – Sets the amount of time before the backlight turns off automatically.
- **Touch control areas** – Allows you to select an area of the screen to limit touch activation to just that area of the screen.

Accessibility features shortcut

Sets quick, easy access to selected features when you triple-tap the Home Button.

Auto-rotate screen

Enable to allow the tablet to rotate the screen depending on the tablet's physical orientation (portrait or landscape).

Switch Access

Allows you to control your device using configurable key combinations.

< Quick Cover >

Allows you to set to lock or unlock your screen automatically using Quick Cover. Keep in mind that this automatic function is available only when your device is set to the None or Swipe unlock mode.

NOTE

- This setting is for the Quick Cover. Other tablet cases are not supported.

< About tablet >

This menu allows you to manage your software updates and view various information relating to your device.

Tablet name

Allows you to set your device name.

Update Center

Allows you to check for software updates.

Battery

Allows you to view battery status, battery level, and battery use information.

Hardware info

Allows you to view the model number, hardware version, up time, Wi-Fi MAC address and Bluetooth address.

Software info

Allows you to view Android version, baseband version, kernel version, build number, and software version.

Legal info

Allows you to view legal documents for LG software, open source licenses and Google legal information.

Activity logs

This feature allows LG, and any third party acting on LG's behalf, to access and use the log information generated by your device. In order to enable this feature, you must consent in the Activity logs menu.

Patent information

Displays LG patent information.

LG Bridge

LG Bridge is an application that helps you conveniently manage images, music, videos, documents, etc. saved on a LG mobile device on your PC. Also, you can update software of a mobile device or back up your files such as contacts and images to your PC.

TIP!

- You can see detailed instructions on how to use LG Bridge in Help menu after installing and opening the program.
- Supported features may vary depending on the device.
- The LG unified USB driver is a program required to connect an LG mobile device to a PC. It is automatically installed when installing LG Bridge.

Features of LG Bridge

Update software of a mobile device on your PC via USB.

Back up and restore the data of your mobile device via USB.

To download the LG Bridge software, please do the following:

- 1 Go to www.lg.com.
- 2 Go to **SUPPORT > Software & Firmware > LG Bridge**.
- 3 Scroll down and click the **Windows PC** or **Mac OS** download link to download LG Bridge.

Minimum system requirements for LG Bridge installation

Item	Windows OS	Mac OS
Operating System	Windows XP 32-bit (Service Pack 3) Windows Vista 32-bit/64-bit Windows 7 32-bit/64-bit Windows 8 32-bit/64-bit Windows 8.1 32-bit/64-bit	Mac OS X 10.7 or later (64-bit)
CPU	1 GHz processor or faster	1 GHz processor or faster
Memory	2 GB RAM or more	2 GB RAM or more
Graphics Card	1024x768, 32-bit color or higher	1024x768, 32-bit color or higher
Hard Disk	At least 500 MB of free space (additional space may be required depending on the amount of data to be stored)	At least 500 MB of free space (additional space may be required depending on the amount of data to be stored)
Required Software	LG unified driver, Windows Media Player 10 or later	LG unified USB driver

How to Connect Your Mobile Device in LG Bridge

You can connect LG Bridge to another device using a USB cable.

Features	Connection Type
Software update	Connecting USB cable
LG Backup (data backup/restoration)	Connecting USB cable

How to use LG AirDrive

You can share or manage content from your tablet on a computer via Wi-Fi or mobile data. When you sign in to the same LG Account on your tablet and computer, you can use the LG AirDrive function.

- 1 Log in to the same LG account on a mobile devices and a PC.
- 2 Enable LG AirDrive in the LG Bridge settings menu.
 - **Settings > More > LG Bridge > LG AirDrive.** A checkmark indicates that the feature is enabled.
- 3 Run the LG Bridge application on your PC and select **LG AirDrive**.

Software Update

Device Software Update

This feature allows you to update the firmware of your device to the latest version conveniently from the internet without the need to visit a service center.

For more information on how to use this function, please visit:

<http://www.lg.com/common/index.jsp>.

As the device firmware update requires the user's full attention for the duration of the update process, please make sure to check all instructions and notes that appear at each step before proceeding. Please note that removing the USB cable or battery during the upgrade may seriously damage your device.

LG Device Software Update via Over-the-Air (OTA)

This feature allows you to update the firmware of your device to the newer version conveniently via OTA without connecting the USB cable. This feature is only available if and when LG makes the newer version of the firmware available for your device.

First, you can check the software version on your device:

Tap  >  >  > **About tablet** > **Software info**.

To perform the device software update, tap  >  >  > **About tablet** > **Update Center** > **Software Update** > **Check now for update**.

TIP!

- Your personal data—including information about your Google account and any other accounts, your system/application data and settings, any downloaded applications and your DRM license —might be lost in the process of updating your device's software. Therefore, LG recommends that you back up your personal data before updating your device's software. LG does not take responsibility for any loss of personal data.

About this user guide

About this user guide

- Before using your device, please carefully read this manual. This will ensure that you use your device safely and correctly.
- Some of the images and screenshots provided in this guide may appear differently on your device.
- Your content may differ from the final product, or from software supplied by service providers or carriers. This content may be subject to change without prior notice. For the latest version of this manual, please visit the LG website at www.lg.com.
- Your device's applications and their functions may vary by country, region, or hardware specifications. LG cannot be held liable for any performance issues resulting from the use of applications developed by providers other than LG.
- LG cannot be held liable for performance or incompatibility issues resulting from edited registry settings being edited or operating system software being modified. Any attempt to customize your operating system may cause the device or its applications to not work as they should.
- Software, audio, wallpaper, images, and other media supplied with your device are licensed for limited use. If you extract and use these materials for commercial or other purposes is, you may be infringing copyright laws. As a user, you are fully and entirely responsible for the illegal use of media.
- Additional charges may be applied for data services, such as messaging, uploading and downloading, auto-syncing, or using location services. To avoid additional charges, select a data plan that is suitable for your needs. Contact your service provider to obtain additional details.

Trademarks

Trademarks

- Copyright ©2015 LG Electronics, Inc. All rights reserved. LG and the LG logo are registered trademarks of LG Group and its related entities. All other trademarks are the property of their respective owners.
- Google™, Google Maps™, Gmail™, YouTube™, Hangouts™ and Play Store™ are trademarks of Google, Inc.
- Bluetooth® is a registered trademark of Bluetooth SIG, Inc. worldwide.
- Wi-Fi® and the Wi-Fi logo are registered trademarks of the Wi-Fi Alliance.
- All other trademarks and copyrights are the property of their respective owners.



This DivX Certified® device has passed rigorous testing to ensure it plays DivX® video. To play purchased DivX movies, first register your device at vod.divx.com. Find your registration code in the DivX VOD section of your device setup menu.

DivX Certified® to play DivX® video up to HD 720p, including premium content.
DivX®, DivX Certified® and associated logos are trademarks of DivX, LLC and are used under license.



Manufactured under license from Dolby Laboratories. Dolby, Dolby Digital Plus, and the double-D symbol are trademarks of Dolby Laboratories.

Accessories

These accessories are available for use with the your device. **(Items described below may be optional.)**

- Travel adaptor
- Quick Start Guide
- USB cable

NOTE

- Always use genuine LG accessories. The supplied items are designed only for this device and may not be compatible with other devices.
- The items supplied with the device and any available accessories may vary depending on the region or service provider.

Troubleshooting

This chapter lists some problems you might encounter when using your device. Some problems require you to call your service provider, but most are easy to fix yourself.

Message	Possible causes	Possible corrective measures
No applications can be set	Not supported by service provider or registration required.	Contact your service provider.
Charging error	Battery is not charged.	Charge battery.
	Outside temperature is too hot or cold.	Make sure device is charging at a normal temperature.
	Contact problem	Check the charger and its connection to the device.
	No voltage	Plug the charger into a different socket.
	Charger defective	Replace the charger.
	Wrong charger	Use only original LG accessories.
Impossible to receive / send photos	Memory full	Delete some images from your device.

Message	Possible causes	Possible corrective measures
Files do not open	Unsupported file format	Check the supported file formats.
No sound	Vibration mode	Check the settings status in the sound menu to make sure you are not in vibration or no interruptions mode.

For Your Safety

Safety Information

Please read and observe the following information for safe and proper use of your tablet and to prevent damage.

WARNING

- This product contains chemicals known to the State of California to cause cancer and birth defects or reproductive harm.
Wash hands after handling.

Caution!

- Violation of the instructions may cause minor or serious damage to the product.

WARNING

Notice for Battery replacement

- For your safety, do not remove the battery incorporated in the product. If you need to replace the battery, take it to the nearest authorized LG Electronics service point or dealer for assistance.
- Li-Ion Battery is a hazardous component which can cause injury.
- Battery replacement by non-qualified professional can cause damage to your device.
- Do not disassemble or open crush, bend or deform, puncture or shred.
- Repairs under warranty, at LG's option, may include replacement parts or boards that are either new or reconditioned, provided that they have functionality equal to that of the parts being replaced.

- Do not modify or remanufacture, attempt to insert foreign objects into the battery, immerse or expose to water or other liquids, expose to fire, explosion or other hazard.
- Only use the battery for the system for which it is specified.
- Do not short circuit a battery or allow metallic conductive objects to contact battery terminals.
- Use of an unqualified battery may present a risk of fire, explosion, leakage or other hazard. Only authorized service providers shall replace battery (If the battery is non-user replaceable).
- Battery usage by children should be supervised.
- Avoid dropping the tablet. If the tablet is dropped, especially on a hard surface, and the user suspects damage, take it to a service center for inspection.
- Improper battery use may result in a fire, explosion or other hazard.
- For those host devices that utilize a USB port as a charging source, the host device's user manual shall include a statement that the device shall only be connected to products that bear the USB-IF logo or have completed the USB-IF compliance program.

Charger and Adapter Safety

- The charger and adapter are intended for indoor use only.
- Insert the battery pack charger vertically into the wall power socket.
- Unplug the power cord and charger during lightning storms to avoid electric shock or fire.
- Use the correct adapter for your tablet when using the battery pack charger abroad.

Battery Information and Care

- Please read the manual of proper installation and removal of the battery.
- Please read the manual of specified charger about charging method.

- Do not damage the power cord by bending, twisting, or heating. Do not use the plug if it is loose as it may cause electric shock or fire.
Do not place any heavy items on the power cord. Do not allow the power cord to be crimped as it may cause electric shock or fire.
- Unplug the power cord prior to cleaning your tablet, and clean the power plug pin when it's dirty. When using the power plug, ensure that it's firmly connected. If not, it may cause excessive heat or fire. If you put your tablet in a pocket or bag without covering the receptacle of the tablet (power plug pin), metallic articles (such as a coin, paperclip or pen) may short-circuit the tablet. Short-circuit of the terminal may damage the battery and cause an explosion. Always cover the receptacle when not in use.
- Recharge the battery after long periods of non-use to maximize battery life. Battery life will vary due to usage pattern and environmental conditions.
- Never store your tablet in temperature less than -20 °C / -4 °F or greater than 50 °C / 122 °F.
- Charging temperature range is between 0 °C / 32 °F and 45 °C / 113 °F.
Do not charge the battery out of recommended temperature range. Charging out of recommended range might cause the generating heat or serious damage of battery. And also, it might cause the deterioration of battery's characteristics and cycle life.
- Do not use or leave the device under the blazing sun or in heated car by sunshine. The device may generate heat, smoke or flame. And also, it might cause the deterioration of battery's characteristics or cycle life.
- The battery back in the device has protection circuit to avoid the danger. Do not use near places that can generate static electricity more than 100 V which could damage the protection circuit. Damaged protection circuits may generate smoke, rupture or ignite.
- When using the device for the first time, if it emits a bad smell, you see rust on it, or anything else abnormal, do not use the equipment and bring the battery to the shop which it was bought.

- Keep device away from babies and small children. If children use the battery, their parents or legal guardians are responsible for supervising and teaching them about the safe handling of device and how to use batteries according to the manual with care.
- If liquid from the battery in the device rubs against skin or clothing, wash with fresh water. It may cause the skin inflammation. Do not use the battery and take it to the nearest authorized LG Electronics service point or dealer for assistance. Be careful that children do not swallow any parts (such as earphone, connection parts of the device, etc.). This could cause asphyxiation or suffocation resulting in serious injury or death.
- Do not handle the tablet with wet hands while it is being charged. It may cause an electric shock or seriously damage your tablet.
- Do not use harsh chemicals (such as alcohol, benzene, thinners, etc.) or detergents to clean your tablet. This could cause a fire.
- Always unplug the charger from the wall socket after the tablet is fully charged to save unnecessary power consumption of the charger.

Care and Maintenance

Your mobile device is a product of superior design and craftsmanship and should be treated with care. The suggestions below will help you fulfill any warranty obligations and allow you to enjoy this product for many years:

Keep your Mobile Device away from: Liquids of any kind

Keep the mobile device dry. Precipitation, humidity, and liquids contain minerals that will corrode electronic circuits. If the mobile device does get wet, do not accelerate drying with the use of an oven, microwave, or dryer, because this may damage the mobile device and could cause a fire or explosion.

Do not use the mobile device with a wet hand.

Doing so may cause an electric shock to you or damage to the mobile device.

Extreme heat or cold

- Avoid temperatures below 0 °C / 32 °F or above 45 °C / 113 °F.
- Use your tablet in temperatures between 0 °C / 32 °F and 40 °C / 104 °F, if possible. Exposing your tablet to extremely low or high temperatures may result in damage, malfunction, or even explosion.

Microwaves

Do not try to dry your mobile device in a microwave oven. Doing so may cause a fire or explosion.

Dust and dirt

Do not expose your mobile device to dust, dirt, or sand.

Sunscreen lotion

Do not expose or wear your device to any liquid like sunscreen lotion. Doing so may cause your device to or damage to the mobile device.

Cleaning solutions

Do not use harsh chemicals, cleaning solvents, or strong detergents to clean the mobile device.

Wipe it with a soft cloths lightly dampened in a mild soap-and-water solution.

Shock or vibration

Do not drop, knock, or shake the mobile device.
Rough handling can break internal circuit boards.

Paint

Do not paint the mobile device. Paint can clog the device's moving parts or ventilation openings and prevent proper operation.

General Notice

- Do not place items containing magnetic components such as a credit card, phone card, bank book, or subway ticket near your device. The magnetism of the device may damage the data stored in the magnetic strip.
- When the tablet is not used for a long period time, store it in a safe place with the power cord unplugged.
- Do not use the device if the antenna is damaged. If a damaged antenna contacts skin, it may cause a slight burn. Please contact an LG Authorized Service Center to replace the damaged antenna.
- The data saved in your tablet might be deleted due to careless use, repair of the tablet, or upgrade of the software. Please backup your important contacts. (pictures, and videos could also be deleted.) The manufacturer is not liable for damage due to the loss of data.
- When you use the tablet in public places, set the volume to vibration so you don't disturb others.
- Do not turn your tablet on or off when putting it to your ear.
- Your device is an electronic device that generates heat during normal operation. Extremely prolonged, direct skin contact in the absence of adequate ventilation may result in discomfort or minor burns. Therefore, use care when handling your device during or immediately after operation.
- Use accessories, such as earphones and headsets, with caution. Ensure that cables are tucked away safely and do not touch the antenna unnecessarily.

Part 15.19 statement

This device complies with part 15 of FCC rules.

Operation is subject to the following two conditions:

(1) This device may not cause harmful interference, and (2) this device must accept any interference received, including interference that causes undesired operation.

Part 15.21 statement

Any changes or modifications not expressly approved by the manufacturer could void the user's authority to operate the equipment.

Part 15.105 statement

This equipment has been tested and found to comply with the limits for a class B digital device, pursuant to Part 15 of the FCC Rules. These limits are designed to provide reasonable protection against harmful interference in a residential installation. This equipment generates uses and can radiate radio frequency energy and, if not installed and used in accordance with the instructions, may cause harmful interference to radio communications. However, there is no guarantee that interference will not occur in a particular installation. If this equipment does cause harmful interference or television reception, which can be determined by turning the equipment off and on, the user is encouraged to try to correct the interference by one or more of the following measures:

- Reorient or relocate the receiving antenna.
- Increase the separation between the equipment and receiver.
- Connect the equipment into an outlet on a circuit different from that to which the receiver is connected.
- Consult the dealer or an experienced radio/TV technician for help.

FCC RF Exposure Information

WARNING! Read this information before operating the device.

In August 1996, the Federal Communications Commission (FCC) of the United States, with its action in Report and Order FCC 96-326, adopted an updated safety standard for human exposure to Radio Frequency (RF) electromagnetic energy emitted by FCC regulated transmitters. Those guidelines are consistent with the safety standard previously set by both U.S. and international standards bodies. The design of this device complies with the FCC guidelines and these international standards.

Bodily Contact During Operation

This device was tested for typical use with the back of the device kept 0 inch (0 cm) from the body.

Caution

Use only the supplied antenna. Use of unauthorized antennas (or modifications to the antenna) could impair call quality, damage the device, void your warranty and/or violate FCC regulations.

Don't use the device with a damaged antenna. A damaged antenna could cause a minor skin burn. Contact your local dealer for a replacement antenna.

Consumer Information About Radio Frequency Emissions

Your wireless device, which contains a radio transmitter and receiver, emits radio frequency energy during use. The following consumer information addresses commonly asked questions about the health effects of wireless devices.

Are wireless devices safe?

Scientific research on the subject of wireless devices and radio frequency ("RF") energy has been conducted worldwide for many years, and continues. In the United States, the Food and Drug Administration ("FDA") and the Federal Communications Commission ("FCC") set policies and procedures for wireless devices. The FDA issued a website

publication on health issues related to device usage where it states, The scientific community at large . . . believes that the weight of scientific evidence does not show an association between exposure to radiofrequency (RF) from the devices and adverse health outcomes. Still the scientific community does recommend conducting additional research to address gaps in knowledge. That research is being conducted around the world and FDA continues to monitor developments in this field. You can access the joint FDA/FCC website at <http://www.fda.gov> (under “C” in the subject index, select Cell Phones > Research). You can also contact the FDA toll-free at (888) 463-6332 or (888) INFO-FDA. In June 2000, the FDA entered into a cooperative research and development agreement through which additional scientific research is being conducted. The FCC issued its own website publication stating that “there is no scientific evidence that proves that wireless device usage can lead to cancer or a variety of other problems, including headaches, dizziness or memory loss”. This publication is available at <http://www.fcc.gov/oet/rfsafety> or through the FCC at (888) 225-5322 or (888) CALL-FCC.

What does “SAR” mean?

In 1996, the FCC, working with the FDA, the U.S. Environmental Protection Agency, and other agencies, established RF exposure safety guidelines for wireless devices in the United States. Before a wireless device model is available for sale to the public, it must be tested by the manufacturer and certified to the FCC that it does not exceed limits established by the FCC. One of these limits is expressed as a Specific Absorption Rate, or “SAR”. SAR is a measure of the rate of absorption of RF energy in the body. Tests for SAR are conducted with the device transmitting at its highest power level in all tested frequency bands. Since 1996, the FCC has required that the SAR of handheld wireless device not exceed 1.6 watts per kilogram, averaged over one gram of tissue.

Although the SAR is determined at the highest power level, the actual SAR value of a wireless device while operating can be less than the reported SAR value. This is because the SAR value may vary from call to call, depending on factors such as proximity to a cell site, the proximity of the device to the body while in use, and the

use of hands-free devices. Before a device model is available for sale to the public, it must be tested and certified to the FCC that it does not exceed the limit established by the government-adopted requirement for safe exposure. The tests are performed in positions and locations (e.g., at the ear and worn on the body) as required by the FCC for each model.

The FCC has granted an Equipment Authorization for this model device with all reported SAR levels evaluated as in compliance with the FCC RF emission guidelines. SAR information on this model device is on file with the FCC and can be found under the Display Grant section of <http://www.fcc.gov/oet/ea/fccid/> after searching on FCC ID ZNFV940N.

For more information about SARs, see the FCC's OET Bulletins 56 and 65 at http://www.fcc.gov/Bureaus/Engineering_Technology/Documents/bulletins or visit the Cellular Telecommunications Industry Association website at http://www.ctia.org/consumer_info/index.cfm/AID/10371. You may also wish to contact the manufacturer of your device.

Can I minimize my RF exposure?

If you are concerned about RF, there are several simple steps you can take to minimize your RF exposure. You can, of course, reduce your talk time. You can place more distance between your body and the source of the RF, as the exposure level drops off dramatically with distance. The FDA/FCC website states that "hands-free kits can be used with wireless devices for convenience and comfort. These systems reduce the absorption of RF energy in the head because the device, which is the source of the RF emissions, will not be placed against the head. On the other hand, if the device is mounted against the waist or other part of the body during use, then that part of the body will absorb more RF energy. Wireless devices marketed in the U.S. are required to meet safety requirements regardless of whether they are used against the head or against the body. Either configuration should result in compliance with the safety limit". Also, if you use your wireless device while in a car, you can use a device with an antenna on the outside of the vehicle. You should also read and follow your wireless device manufacturer's instructions for the safe operation of your device.

Do wireless devices pose any special risks to children?

The FDA/FCC website states that “the scientific evidence does not show a danger to users of wireless communication devices, including children”. The FDA/FCC website further states that “some groups sponsored by other national governments have advised that children be discouraged from using wireless device at all”. For example, the Stewart Report from the United Kingdom [“UK”] made such a recommendation in December 2000. In this report a group of independent experts noted that no evidence exists that using a device causes brain tumors or other ill effects. [The UK’s] recommendation to limit device use by children was strictly precautionary; it was not based on scientific evidence that any health hazard exists. A copy of the UK’s leaflet is available at <http://www.dh.gov.uk> (search “mobile”), or you can write to: NRPB, Chilton, Didcot, Oxon OX11 0RQ, United Kingdom. Copies of the UK’s annual reports on mobile device and RF are available online at www.iegmp.org.uk and <http://www.hpa.org.uk/radiation/> (search “mobile”). Parents who wish to reduce their children’s RF exposure may choose to restrict their children’s wireless device use.

Where can I get further information about RF emissions?

For further information, see the following additional resources (websites current as of April 2005):

U.S. Food and Drug Administration

FDA Consumer magazine

November-December 2000

Telephone: (888) INFO-FDA

<http://www.fda.gov> (Under “C” in the subject index, select Cell Phones > Research.)

U.S. Federal Communications Commission

445 12th Street, S.W.

Washington, D.C. 20554

Telephone: (888) 225-5322

<http://www.fcc.gov/oet/rfsafety>

Independent Expert Group on Mobile Devices

<http://www.iegmp.org.uk>

Royal Society of Canada Expert Panels on Potential Health Risks of Radio Frequency Fields from Wireless Telecommunication Devices

283 Sparks Street

Ottawa, Ontario K1R 7X9

Canada

Telephone: (613) 991-6990

World Health Organization

Avenue Appia 20

1211 Geneva 27

Switzerland

Telephone: 011 41 22 791 21 11

<http://www.who.int/mediacentre/factsheets/fs193/en/>

International Commission on Non-Ionizing Radiation Protection

c/o Bundesamt für Strahlenschutz

Ingolstaedter Landstr. 1

85764 Oberschleissheim

Germany

Telephone: 011 49 1888 333 2156

<http://www.icnirp.de>

Engineering in Medicine and Biology Society, Committee on Man and Radiation (COMAR) of the Institute of Electrical and Electronics Engineers

<http://ewh.ieee.org/soc/embs/comar/>

Consumer Information on SAR

(Specific Absorption Rate)

This model device meets the government's requirements for exposure to radio waves. Your wireless device is a radio transmitter and receiver. It is designed and manufactured not to exceed the emission limits for exposure to Radio Frequency (RF) energy set by the Federal Communications Commission of the U.S. Government. These limits are part of comprehensive guidelines and establish permitted levels of RF energy for the general population. The guidelines are based on standards that were developed by independent scientific organizations through periodic and thorough evaluation of scientific studies. The standards include a substantial safety margin designed to assure the safety of all persons, regardless of age and health.

The exposure standard for wireless mobile devices employs a unit of measurement known as the Specific Absorption Rate, or SAR. The SAR limit set by the FCC is 1.6 W/kg.

Tests for SAR are conducted using standard operating positions specified by the FCC with the device transmitting at its highest certified power level in all tested frequency bands. Although SAR is determined at the highest certified power level, the actual SAR level of the device while operating can be well below the maximum value. Because the device is designed to operate at multiple power levels to use only the power required to reach the network, in general, the closer you are to a wireless base station antenna, the lower the power output.

Before a device model is available for sale to the public, it must be tested and certified to the FCC that it does not exceed the limit established by the government-adopted requirement for safe exposure. The tests are performed in positions and locations (e.g., at the ear and worn on the body) as required by the FCC for each model.

The highest SAR value for this device when worn on the body, as described in this user guide, is **0.53 W/kg**. (body-worn measurements differ among device models, depending upon available accessories and FCC requirements). While there may be differences between SAR levels of various devices and at various positions, they all meet the government requirement for safe exposure.

The FCC has granted an Equipment Authorization for this model device with all reported SAR levels evaluated as in compliance with the FCC RF emission guidelines. SAR information on this model device is on file with the FCC and can be found under the Display Grant section of <http://www.fcc.gov/oet/fccid> after searching on FCC ID ZNFV940N. Additional information on Specific Absorption Rates (SAR) can be found on the Cellular Telecommunications Industry Association (CTIA) website at <http://www.ctia.org/>.

* In the United States and Canada, the SAR limit for mobile device used by the public is 1.6 watts/kg (W/kg) averaged over one gram of tissue. The standard incorporates a substantial margin of safety to give additional protection for the public and to account for any variations in measurements.

Caution: Avoid potential hearing loss.

Prolonged exposure to loud sounds (including music) is the most common cause of preventable hearing loss. Some scientific research suggests that using portable audio devices, such as portable music players and cellular telephones, at high volume settings for long durations may lead to permanent noise-induced hearing loss. This includes the use of headphones (including headsets, earbuds and Bluetooth® or other wireless devices). Exposure to very loud sound has also been associated in some studies with tinnitus (a ringing in the ear), hypersensitivity to sound and distorted hearing. Individual susceptibility to noise-induced hearing loss and other potential hearing problems varies. The amount of sound produced by a portable audio device varies depending on the nature of the sound, the device, the device settings and the headphones. You should follow some commonsense recommendations when using any portable audio device:

- Set the volume in a quiet environment and select the lowest volume at which you can hear adequately.
- When using headphones, turn the volume down if you cannot hear the people speaking near you or if the person sitting next to you can hear what you are listening to.
- Do not turn the volume up to block out noisy surroundings. If you choose to listen to your portable device in a noisy environment, use noise-cancelling headphones to block out background environmental noise.
- Limit the amount of time you listen. As the volume increases, less time is required before your hearing could be affected.
- Avoid using headphones after exposure to extremely loud noises, such as rock concerts, that might cause temporary hearing loss. Temporary hearing loss might cause unsafe volumes to sound normal.
- Do not listen at any volume that causes you discomfort. If you experience ringing in your ears, hear muffled speech or experience any temporary hearing difficulty after listening to your portable audio device, discontinue use and consult your doctor.

You can obtain additional information on this subject from the following sources:

Safety 205

American Academy of Audiology 11730

Plaza American Drive, Suite 300

Reston, VA 20190

Voice: (800) 222-2336

Email: info@audiology.org

Internet: www.audiology.org

National Institute on Deafness and Other Communication

Disorders

National Institutes of Health

31 Center Drive, MSC 2320

Bethesda, MD USA 20892-2320

Voice: (301) 496-7243

Email: nidcdinfo@nih.gov

Internet: <http://www.nidcd.nih.gov/health/hearing>

National Institute for Occupational Safety and Health Hubert H. Humphrey Bldg.

200 Independence Ave., SW Washington, DC 20201 Voice:

1-800-35-NIOSH (1-800-356-4674)

Internet: <http://www.cdc.gov/niosh/topics/noise/default.html>

TIA Safety Information

The following is the complete TIA Safety Information for wireless handheld devices.

Exposure to Radio Frequency Signal

Your wireless handheld portable device is a low power radio transmitter and receiver. When ON, it receives and sends out Radio Frequency (RF) signals.

In August, 1996, the Federal Communications Commissions (FCC) adopted RF exposure guidelines with safety levels for handheld wireless devices. Those guidelines are consistent with the safety standards previously set by both U.S. and international standards bodies:

ANSI C95.1 (1992) *

NCRP Report 86 (1986)

ICNIRP (1996)

* American National Standards Institute; National Council on Radiation Protection and Measurements; International Commission on Non-Ionizing Radiation Protection
Those standards were based on comprehensive and periodic evaluations of the relevant scientific literature. For example, over 120 scientists, engineers, and physicians from universities, government health agencies, and industry reviewed the available body of research to develop the ANSI Standard (C95.1).

The design of your device complies with the FCC guidelines (and those standards).

Antenna Care

Use only the supplied or an approved replacement antenna. Unauthorized antennas, modifications, or attachments could damage the device and may violate FCC regulations.

Tips on Efficient Operation

For your device to operate most efficiently:

Don't touch the antenna unnecessarily when the tablet is in use. Contact with the antenna affects call quality and may cause the tablet to operate at a higher power level than otherwise needed.

Electronic Devices

Most modern electronic equipment is shielded from RF signals. However, certain electronic equipment may not be shielded against the RF signals from your wireless device.

Pacemakers

The Health Industry Manufacturers Association recommends that a minimum separation of six (6) inches be maintained between a handheld wireless device and a pacemaker to avoid potential interference with the pacemaker. These recommendations are consistent with the independent research by and recommendations of Wireless Technology Research.

Persons with pacemakers:

- Should ALWAYS keep the device more than six (6) inches from their pacemaker when the device is turned ON;
- Should not carry the device in a breast pocket;
- Should use the ear opposite the pacemaker to minimize the potential for interference;
- Should turn the tablet OFF immediately if there is any reason to suspect that interference is taking place.

Hearing Aids

Some digital wireless device may interfere with some hearing aids. In the event of such interference, you may want to consult your service provider (or call the customer service line to discuss alternatives).

Other Medical Devices

If you use any other personal medical device, consult the manufacturer of your device to determine if it is adequately shielded from external RF energy. Your physician may be able to assist you in obtaining this information.

Health Care Facilities

Turn your device OFF in health care facilities when any regulations posted in these areas instruct you to do so. Hospitals or health care facilities may use equipment that could be sensitive to external RF energy.

Vehicles

RF signals may affect improperly installed or inadequately shielded electronic systems in motor vehicles. Check with the manufacturer or its representative regarding your vehicle. You should also consult the manufacturer of any equipment that has been added to your vehicle.

Posted Facilities

Turn your device OFF in any facility where posted notices so require.

Aircraft

FCC regulations prohibit using your device while in the air. Switch OFF your tablet before boarding an aircraft.

Blasting Areas

To avoid interfering with blasting operations, turn your device OFF when in a “blasting area” or in areas posted: “Turn off two-way radio”. Obey all signs and instructions.

Potentially Explosive Atmosphere

Turn your device OFF when in any area with a potentially explosive atmosphere and obey all signs and instructions. Sparks in such areas could cause an explosion or fire resulting in bodily injury or even death.

Areas with a potentially explosive atmosphere are often, but not always marked clearly. Potential areas may include: fueling areas (such as gasoline stations); below deck on boats; fuel or chemical transfer or storage facilities; vehicles using liquefied petroleum gas (such as propane or butane); areas where the air contains chemicals or particles (such as grain, dust, or metal powders); and any other area where you would normally be advised to turn off your vehicle engine.

For Vehicles Equipped with an Air Bag

An air bag inflates with great force. DO NOT place objects, including either installed or portable wireless equipment, in the area over the air bag or in the air bag deployment area. If in-vehicle wireless equipment is improperly installed and the air bag inflates, serious injury could result.

FDA Consumer Update



The U.S. Food and Drug Administration's Center for Devices and Radiological Health Consumer Update on Mobile Tablets:

1. Do tablets pose a health hazard?

The available scientific evidence does not show that any health problems are associated with using tablets.

There is no proof, however, that tablets are absolutely safe. Tablets emit low levels of Radio Frequency (RF) energy in the microwave range while being used. They also emit very low levels of RF when in idle mode. Whereas high levels of RF can produce health effects (by heating tissue), exposure to low level RF that does not produce heating effects causes no known adverse health effects. Many studies of low level RF exposures have not found any biological effects. Some studies have suggested that some biological effects may occur, but such findings have not been confirmed by additional research. In some cases, other researchers have had difficulty in reproducing those studies, or in determining the reasons for inconsistent results.

2. What is the FDA's role concerning the safety of tablets?

Under the law, the FDA does not review the safety of radiation-emitting consumer products such as tablets before they can be sold, as it does with new drugs or medical devices. However, the agency has authority to take action if tablets are shown to emit Radio Frequency (RF) energy at a level that is hazardous to the user. In such a case, the FDA could require the manufacturers of tablets to notify users of the health hazard and to repair, replace, or recall the tablets so that the hazard no longer exists.

Although the existing scientific data does not justify FDA regulatory actions, the FDA has urged the tablet industry to take a number of steps, including the following:

- Support needed research into possible biological effects of RF of the type emitted by tablets;
- Design tablets in a way that minimizes any RF exposure to the user that is not necessary for device function; and
- Cooperate in providing users of tablets with the best possible information on possible effects of tablet use on human health.

The FDA belongs to an interagency working group of the federal agencies that have responsibility for different aspects of RF safety to ensure coordinated efforts at the federal level. The following agencies belong to this working group:

- National Institute for Occupational Safety and Health
- Environmental Protection Agency
- Occupational Safety and Health Administration
- National Telecommunications and Information Administration

The National Institutes of Health participates in some interagency working group activities, as well.

The FDA shares regulatory responsibilities for tablets with the Federal Communications Commission (FCC). All tablets that are sold in the United States must comply with FCC safety guidelines that limit RF exposure. The FCC relies on the FDA and other health agencies for safety questions about tablets.

The FCC also regulates the base stations that the tablet networks rely upon. While these base stations operate at higher power than do the tablets themselves, the RF exposures that people get from these base stations are typically thousands of times lower than those they can get from tablets. Base stations are thus not the subject of the safety questions discussed in this document.

3. What kinds of devices are the subject of this update?

The term “wireless device” refers here to handheld wireless devices with built-in antennas, often called “cell”, “mobile”, or “PCS” devices. These types of wireless devices can expose the user to measurable Radio Frequency (RF) energy because of the short distance between the device and the user’s head.

These RF exposures are limited by FCC safety guidelines that were developed with the advice of the FDA and other federal health and safety agencies. When the device is located at greater distances from the user, the exposure to RF is drastically lower because a person’s RF exposure decreases rapidly with increasing distance from the source.

4. What are the results of the research done already?

The research done thus far has produced conflicting results, and many studies have suffered from flaws in their research methods. Animal experiments investigating the effects of Radio Frequency (RF) energy exposures characteristic of wireless devices have yielded conflicting results that often cannot be repeated in other laboratories. A few animal studies, however, have suggested that low levels of RF could accelerate the development of cancer in laboratory animals. However, many of the studies that showed increased tumor development used animals that had been genetically engineered or treated with cancer-causing chemicals so as to be pre-disposed to develop cancer in the absence of RF exposure. Other studies exposed the animals to RF for up to 22 hours per day. These conditions are not similar to the conditions under which people use wireless devices, so we do not know with certainty what the results of such studies mean for human health. Three large epidemiology studies have been published since December 2000. Between them, the studies investigated any possible

association between the use of wireless devices and primary brain cancer, glioma, meningioma, or acoustic neuroma, tumors of the brain or salivary gland, leukemia, or other cancers. None of the studies demonstrated the existence of any harmful health effects from wireless device RF exposures. However, none of the studies can answer questions about long-term exposures, since the average period of device use in these studies was around three years.

5. What research is needed to decide whether RF exposure from tablets poses a health risk?

A combination of laboratory studies and epidemiological studies of people actually using tablets would provide some of the data that are needed. Lifetime animal exposure studies could be completed in a few years. However, very large numbers of animals would be needed to provide reliable proof of a cancer promoting effect if one exists. Epidemiological studies can provide data that is directly applicable to human populations, but ten or more years follow-up may be needed to provide answers about some health effects, such as cancer. This is because the interval between the time of exposure to a cancer-causing agent and the time tumors develop — if they do — may be many, many years. The interpretation of epidemiological studies is hampered by difficulties in measuring actual RF exposure during day-to-day use of tablets. Many factors affect this measurement, such as the angle at which the tablet is held, or which model of tablet is used.

6. What is the FDA doing to find out more about the possible health effects of tablet RF?

The FDA is working with the U.S. National Toxicology Program and with groups of investigators around the world to ensure that high priority animal studies are conducted to address important questions about the effects of exposure to Radio Frequency (RF) energy.

The FDA has been a leading participant in the World Health Organization International Electro Magnetic Fields (EMF) Project since its inception in 1996. An influential result of this work has been the development of a detailed agenda of research needs that has

driven the establishment of new research programs around the world. The project has also helped develop a series of public information documents on EMF issues.

The FDA and the Cellular Telecommunications & Internet Association (CTIA) have a formal Cooperative Research And Development Agreement (CRADA) to do research on wireless device safety. The FDA provides the scientific oversight, obtaining input from experts in government, industry, and academic organizations. CTIA-funded research is conducted through contracts with independent investigators. The initial research will include both laboratory studies and studies of wireless device users. The CRADA will also include a broad assessment of additional research needs in the context of the latest research developments around the world.

7. How can I find out how much Radio Frequency energy exposure I can get by using my tablet?

All tablets sold in the United States must comply with Federal Communications Commission (FCC) guidelines that limit Radio Frequency (RF) energy exposures. The FCC established these guidelines in consultation with the FDA and the other federal health and safety agencies. The FCC limit for RF exposure from wireless devices is set at a Specific Absorption Rate (SAR) of 1.6 watts per kilogram (1.6 W/kg). The FCC limit is consistent with the safety standards developed by the Institute of Electrical and Electronic Engineering (IEEE) and the National Council on Radiation Protection and Measurement. The exposure limit takes into consideration the body's ability to remove heat from the tissues that absorb energy from the tablet and is set well below levels known to have effects. Manufacturers of tablets must report the RF exposure level for each model of tablet to the FCC. The FCC website (<http://www.fcc.gov/oet/rfsafety>) gives directions for locating the FCC identification number on your tablet so you can find your tablet's RF exposure level in the online listing.

8. What has the FDA done to measure the Radio Frequency energy coming from tablets?

The Institute of Electrical and Electronic Engineers (IEEE) is developing a technical standard for measuring the Radio Frequency (RF) energy exposure from tablets and

other wireless handsets with the participation and leadership of FDA scientists and engineers. The standard, “Recommended Practice for Determining the Spatial-Peak Specific Absorption Rate (SAR) in the Human Body Due to Wireless Communications Devices: Experimental Techniques”, sets forth the first consistent test methodology for measuring the rate at which RF is deposited in the heads and bodies of tablet users. The test method uses a tissue-simulating model of the human head and body. Standardized SAR test methodology is expected to greatly improve the consistency of measurements made at different laboratories on the same tablet. SAR is the measurement of the amount of energy absorbed in tissue, either by the whole body or a small part of the body. It is measured in watts/kg (or milliwatts/g) of matter. This measurement is used to determine whether a tablet complies with safety guidelines.

9. What steps can I take to reduce my exposure to Radio Frequency energy from my tablet?

If there is a risk from these products — and at this point we do not know that there is — it is probably very small. But if you are concerned about avoiding even potential risks, you can take a few simple steps to minimize your exposure to Radio Frequency (RF) energy. Since time is a key factor in how much exposure a person receives, reducing the amount of time spent using a tablet will reduce RF exposure. If you must conduct extended conversations using a wireless device every day, you could place more distance between your body and the source of the RF, since the exposure level drops off dramatically with distance. For example, you could use a headset and carry the tablet away from your body or use a wireless device connected to a remote antenna. Again, the scientific data does not demonstrate that tablets are harmful. But if you are concerned about the RF exposure from these products, you can use measures like those described above to reduce your RF exposure from tablet use.

10. What about children using tablets?

The scientific evidence does not show a danger to users of tablets, including children and teenagers. If you want to take steps to lower exposure to Radio Frequency (RF) energy, the measures described above would apply to children and teenagers using

tablets. Reducing the time of tablet use and increasing the distance between the user and the RF source will reduce RF exposure.

Some groups sponsored by other national governments have advised that children be discouraged from using wireless devices at all. For example, the government in the United Kingdom distributed leaflets containing such a recommendation in December 2000. They noted that no evidence exists that using a wireless device causes brain tumors or other ill effects.

Their recommendation to limit wireless device use by children was strictly precautionary; it was not based on scientific evidence that any health hazard exists.

11. What about wireless communications device interference with medical equipment?

Radio Frequency (RF) energy from wireless communications devices can interact with some electronic devices. For this reason, the FDA helped develop a detailed test method to measure Electro Magnetic Interference (EMI) of implanted cardiac pacemakers and defibrillators from wireless devices. This test method is now part of a standard sponsored by the Association for the Advancement of Medical Instrumentation (AAMI). The final draft, a joint effort by the FDA, medical device manufacturers, and many other groups, was completed in late 2000. This standard will allow manufacturers to ensure that cardiac pacemakers and defibrillators are safe from wireless communications device EMI.

The FDA has tested hearing aids for interference from handheld wireless devices and helped develop a voluntary standard sponsored by the Institute of Electrical and Electronic Engineers (IEEE). This standard specifies test methods and performance requirements for hearing aids and wireless communications devices so that no interference occurs when a person uses a “compatible” device and a “compatible” hearing aid at the same time. This standard was approved by the IEEE in 2000.

The FDA continues to monitor the use of wireless communications devices for possible interactions with other medical devices. Should harmful interference be found to occur, the FDA will conduct testing to assess the interference and work to resolve the problem.

The FDA continues to monitor the use of wireless devices for possible interactions with other medical devices. Should harmful interference be found to occur, the FDA will conduct testing to assess the interference and work to resolve the problem.

12. Where can I find additional information?

For additional information, please refer to the following resources:

Federal Communications Commission (FCC) RF Safety Program
(<http://www.fcc.gov/oet/rfsafety>)

International Commission on Non-Ionizing Radiation Protection
(<http://www.icnirp.de>)

World Health Organization (WHO) International EMF Project
(<http://www.who.int/emf>)

National Radiological Protection Board (UK)
(<http://www.hpa.org.uk/radiation/>)

Driving

Check the laws and regulations on the use of wireless devices in the areas where you drive and always obey them. Also, if using your device while driving, please observe the following:

- Give full attention to driving -- driving safely is your first responsibility;
- Use hands-free operation, if available;
- Pull off the road and park before using it.

Open Source Software Notice Information

To obtain the source code under GPL, LGPL, MPL, and other open source licenses, that is contained in this product, please visit <http://opensource.lge.com>.

In addition to the source code, all referred license terms, warranty disclaimers and copyright notices are available for download.

LG Electronics will also provide open source code to you on CD-ROM for a charge covering the cost of performing such distribution (such as the cost of media, shipping, and handling) upon email request to opensource@lge.com.

This offer is valid for three (3) years from the date on which you purchased the product.

HOW TO UPDATE YOUR DEVICE

Access to latest firmware releases, new software functions and improvements.

- **Select the software update in settings menu on your device.**
- **Update your device by connecting it to your PC.** For more information about using this function, please visit <http://www.lg.com/common/index.jsp> select country and language.

Trademarks

- Bluetooth® is a registered trademark of the Bluetooth SIG, Inc. worldwide.
- Wi-Fi® and the Wi-Fi logo are registered trademarks of the Wi-Fi Alliance.

Anti-Theft Guide

You can set up your device to prevent other people from using it if it's been reset to factory settings without your permission. For example, if your device is lost, stolen, or wiped, only someone with your Google account or screen lock information can use the device.

All you need to make sure your device is protected is:

- **Set a screen lock:** If your device is lost or stolen but you have a screen lock set, the device can't be erased using the Settings menu unless your screen is unlocked.
- **Add your Google account on your device:** If your device is wiped but you have your Google account on it, the device can't finish the setup process until your Google account information is entered again.

After your device is protected, you'll need to either unlock your screen or enter your Google account password if you need to do a factory reset. This ensures that you or someone you trust is doing the reset.

Note

- Do not forget your Google account and password you had added to your device prior to performing a factory reset. If you can't provide the account information during the setup process, you won't be able to use the device at all after performing the factory reset.

Limited Warranty Statement

ARBITRATION NOTICE: THIS LIMITED WARRANTY CONTAINS AN ARBITRATION PROVISION THAT REQUIRES YOU AND LG TO RESOLVE DISPUTES BY BINDING ARBITRATION INSTEAD OF IN COURT, UNLESS YOU CHOOSE TO OPT OUT. IN ARBITRATION, CLASS ACTIONS AND JURY TRIALS ARE NOT PERMITTED. PLEASE SEE THE SECTION TITLED "PROCEDURE FOR RESOLVING DISPUTES" BELOW.

Warranty Laws

The following laws govern warranties that arise in retail sales of consumer goods:

- The California Song-Beverly Consumer Warranty Act [CC §§1790 et seq],
- The California Uniform Commercial Code, Division Two [Com C §§2101 et seq], and
- The federal Magnuson-Moss Warranty Federal Trade Commission Improvement Act [15 USC §§2301 et seq; 16 CFR Parts 701– 703]. A typical Magnuson-Moss Act warranty is a written promise that the product is free of defects or a written promise to refund, repair, or replace defective goods. [See 15 USC §2301(6).] Remedies include damages for failing to honor a written warranty or service contract or for violating disclosure provisions. [See 15 USC §2310(d).] Except for some labeling and disclosure requirements, the federal Act does not preempt state law. [See 15 USC §2311.]

1. WHAT THIS WARRANTY COVERS:

LG offers you a limited warranty that the enclosed subscriber unit and its enclosed accessories will be free from defects in material and workmanship, according to the following terms and conditions:

- (1) The limited warranty for the product extends for TWELVE (12) MONTHS beginning on the date of purchase of the product with valid proof of purchase, or absent valid proof of purchase, FIFTEEN (15) MONTHS from date of manufacture as determined by the unit's manufacture date code.
- (2) The limited warranty extends only to the original purchaser of the product and is not assignable or transferable to any subsequent purchaser/end user.
- (3) This warranty is good only to the original purchaser of the product during the warranty period as long as it is in the U.S., including Alaska, Hawaii, U.S. Territories and Canada.

- (4) The external housing and cosmetic parts shall be free of defects at the time of shipment and, therefore, shall not be covered under these limited warranty terms.
- (5) Upon request from LG, the consumer must provide information to reasonably prove the date of purchase.
- (6) The customer shall bear the cost of shipping the product to the Customer Service Department of LG. LG shall bear the cost of shipping the product back to the consumer after the completion of service under this limited warranty.

2. WHAT THIS WARRANTY DOES NOT COVER:

- (1) Defects or damages resulting from use of the product in other than its normal and customary manner.
- (2) Defects or damages from abnormal use, abnormal conditions, improper storage, exposure to moisture or dampness, unauthorized modifications, unauthorized connections, unauthorized repair, misuse, neglect, abuse, accident, alteration, improper installation, or other acts which are not the fault of LG, including damage caused by shipping, blown fuses, spills of food or liquid.
- (3) Breakage or damage to antennas unless caused directly by defects in material or workmanship.
- (4) That the Customer Service Department at LG was not notified by consumer of the alleged defect or malfunction of the product during the applicable limited warranty period.
- (5) Products which have had the serial number removed or made illegible.
- (6) This limited warranty is in lieu of all other warranties, express or implied either in fact or by operations of law, statutory or otherwise, including, but not limited to any implied warranty of marketability or fitness for a particular use.
- (7) Damage resulting from use of non LG approved accessories.
- (8) All plastic surfaces and all other externally exposed parts that are scratched or damaged due to normal customer use.
- (9) Products operated outside published maximum ratings.
- (10) Products used or obtained in a rental program.
- (11) Consumables (such as fuses).

3. WHAT LG WILL DO:

LG will, at its sole option, either repair, replace or refund the purchase price of any unit that is covered under this limited warranty. LG may choose at its option to use functionally equivalent re-conditioned, refurbished or new units or parts or any units. In addition, LG will not re-install or back-up any data, applications or software that you have added to your tablet. It is therefore recommended that you back-up any such data or information prior to sending the unit to LG to avoid the permanent loss of such information.

4. STATE LAW RIGHTS:

No other express warranty is applicable to this product. THE DURATION OF ANY IMPLIED WARRANTIES, INCLUDING THE IMPLIED WARRANTY OF MARKETABILITY OR MERCHANTABILITY OR FITNESS FOR A PARTICULAR PURPOSE, IS LIMITED TO THE DURATION OF THE EXPRESS WARRANTY HEREIN. LG SHALL NOT BE LIABLE FOR THE LOSS OF THE USE OF THE PRODUCT, INCONVENIENCE, LOSS OR ANY OTHER DAMAGES, DIRECT OR CONSEQUENTIAL, ARISING OUT OF THE USE OF, OR INABILITY TO USE, THIS PRODUCT OR FOR ANY BREACH OF ANY EXPRESS OR IMPLIED WARRANTY, INCLUDING THE IMPLIED WARRANTY OF MARKETABILITY OR MERCHANTABILITY OR FITNESS FOR A PARTICULAR PURPOSE APPLICABLE TO THIS PRODUCT.

Some states do not allow the exclusive limitation of incidental or consequential damages or limitations on how long an implied warranty lasts; so these limitations or exclusions may not apply to you. This warranty gives you specific legal rights and you may also have other rights which vary from state to state.

5. HOW TO GET WARRANTY SERVICE:

To obtain warranty service, please call or fax to the following telephone numbers from anywhere in the continental United States:

Tel. 1-800-793-8896

Or visit <http://www.lg.com/us/support>. Correspondence may also be mailed to:

LG Electronics Service- Mobile Handsets, P.O. Box 240007, Huntsville, AL 35824

DO NOT RETURN YOUR PRODUCT TO THE ABOVE ADDRESS. Please call or write for the location of the LG authorized service center nearest you and for the procedures for obtaining warranty claims.

PROCEDURE FOR RESOLVING DISPUTES:

ALL DISPUTES BETWEEN YOU AND LG ARISING OUT OF OR RELATING IN ANY WAY TO THIS LIMITED WARRANTY OR THE PRODUCT SHALL BE RESOLVED EXCLUSIVELY THROUGH BINDING ARBITRATION, AND NOT IN A COURT OF GENERAL JURISDICTION. BINDING ARBITRATION MEANS THAT YOU AND LG ARE EACH WAIVING THE RIGHT TO A JURY TRIAL AND TO BRING OR PARTICIPATE IN A CLASS ACTION.

Definitions. For the purposes of this section, references to "LG" mean LG Electronics MobileComm U.S.A., Inc., its parents, subsidiaries and affiliates, and each of their officers, directors, employees, agents, beneficiaries, predecessors in interest, successors, assigns and suppliers; references to "dispute" or "claim" shall include any dispute, claim or controversy of any kind whatsoever (whether based in contract, tort, statute, regulation, ordinance, fraud, misrepresentation or any other legal or equitable theory) arising out of or relating in any way to the sale, condition or performance of the product or this Limited Warranty.

Agreement to Binding Arbitration and Class Action Waiver. You and LG agree to resolve any claims between us only by binding arbitration on an individual basis, unless you opt out as provided below. Any dispute between you and LG shall not be combined or consolidated with a dispute involving any other person's or entity's product or claim. More specifically, without limitation of the foregoing, any dispute between you and LG shall not under any circumstances proceed as part of a class or representative action. Instead of arbitration, either party may bring an individual action in small claims court, but that small claims court action may not be brought on a class or representative basis.

Arbitration Rules and Procedures. To begin arbitration of a claim, either you or LG must make a written demand for arbitration. The arbitration will be administered by the American Arbitration Association (AAA) and will be conducted before a single arbitrator under the AAA's Consumer Arbitration Rules that are in effect at the time the arbitration is initiated (referred to as the "AAA Rules") and under the procedures set forth in this section. The AAA Rules are available online at www.adr.org/consumer. Send a copy of your written demand for arbitration, as well as a copy of this provision, to the AAA in the manner described in the AAA Rules. You must also send a copy of your written demand to LG at LG Electronics, USA, Inc. Attn: Legal Department-Arbitration 1000 Sylvan Avenue Englewood Cliffs, NJ 07632.

If there is a conflict between the AAA Rules and the rules set forth in this section, the rules set forth in this section will govern. This arbitration provision is governed by the Federal Arbitration Act. Judgment may be entered on the arbitrator's award in any court of competent jurisdiction. All issues are for the arbitrator to decide, except that issues relating to the scope and enforceability of the arbitration provision and to the arbitrability of the dispute are for the court to decide. The arbitrator is bound by the terms of this provision.

Governing Law: The law of the state of your residence shall govern this Limited Warranty and any disputes between us except to the extent that such law is preempted by or inconsistent with applicable federal law.

Fees/Costs. You do not need to pay any fee to begin an arbitration. Upon receipt of your written demand for arbitration, LG will promptly pay all arbitration filing fees to the AAA unless you seek more than \$25,000 in damages, in which case the payment of these fees will be governed by the AAA Rules. Except as otherwise provided for herein, LG will pay all AAA filing, administration and arbitrator fees for any arbitration initiated in accordance with the AAA Rules and this arbitration provision. If you prevail in the arbitration, LG will pay your reasonable attorneys' fees and expenses to the extent required by applicable law. If the arbitrator finds either the substance of your claim or the relief sought in the demand is frivolous or brought for an improper purpose (as measured by the standards set forth in Federal Rule of Civil Procedure 11(b)), then the payment of all arbitration fees will be governed by the AAA Rules. In such a situation, you agree to reimburse LG for all monies previously disbursed by it that are otherwise your obligation to pay under the AAA Rules. Except as otherwise provided for, LG waives any rights it may have to seek attorneys' fees and expenses from you if LG prevails in the arbitration.

Hearings and Location. If your claim is for \$25,000 or less, you may choose to have the arbitration conducted solely on the basis of (1) documents submitted to the arbitrator, (2) through a telephonic hearing, or (3) by an in-person hearing as established by the AAA Rules. If your claim exceeds \$25,000, the right to a hearing will be determined by the AAA Rules. Any in-person arbitration hearings will be held at a location within the federal judicial district in which you reside unless we both agree to another location or we agree to a telephonic arbitration.

Opt Out. You may opt out of this dispute resolution procedure. If you opt out, neither you nor LG can require the other to participate in an arbitration proceeding. To opt out, you must send notice to LG no later than 30 calendar days from the date of the first consumer purchaser's purchase of the product by either: (i) sending an e-mail to optout@lge.com, with the subject line: "Arbitration Opt Out" or (ii) calling 1-800-980-2973. You must include in the opt out e-mail or provide by telephone: (a) your name and address; (b) the date on which the product was purchased; (c) the product model name or model number; and (d) the IMEI or MEID or Serial Number, as applicable (the IMEI or MEID or Serial Number can be found (i) on the product box; or (ii) on a label on the back of the product beneath the battery, if the battery is removable. You may only opt out of the dispute resolution procedure in the manner described above (that is, by e-mail or telephone); no other form of notice will be effective to opt out of this dispute resolution procedure. Opting out of this dispute resolution procedure will not affect the coverage of the Limited Warranty in any way, and you will continue to enjoy the full benefits of the Limited Warranty. If you keep this product and do not opt out, then you accept all terms and conditions of the arbitration provision described above.

