



Congratulations for the purchase of an ARCHOS device! This quick start guide helps you to start using your device properly. If you have more questions concerning the use of your device, visit us at:



twitter.com/archos



www.facebook.com/archos

Blog

<https://blog.archos.com/>



<http://faq.archos.com/>



www.archos.com, click Support > After-sales support



www.archos.com, click Support > Downloads > Declaration of conformity

As we are often updating and improving our products, your device's software may have a slightly different appearance or modified functionality than presented in this quick start guide.



Unboxing

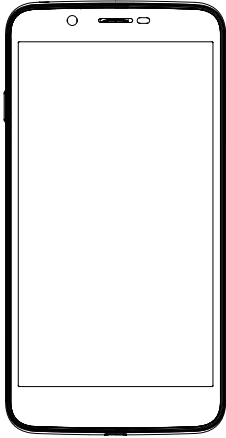

ARCHOS 55 Helium



Warranty, legal and safety notice

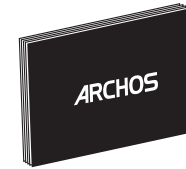

Quick start guide



Charger adapter

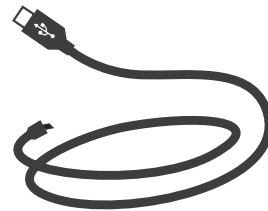

Charging cable

Describing your device

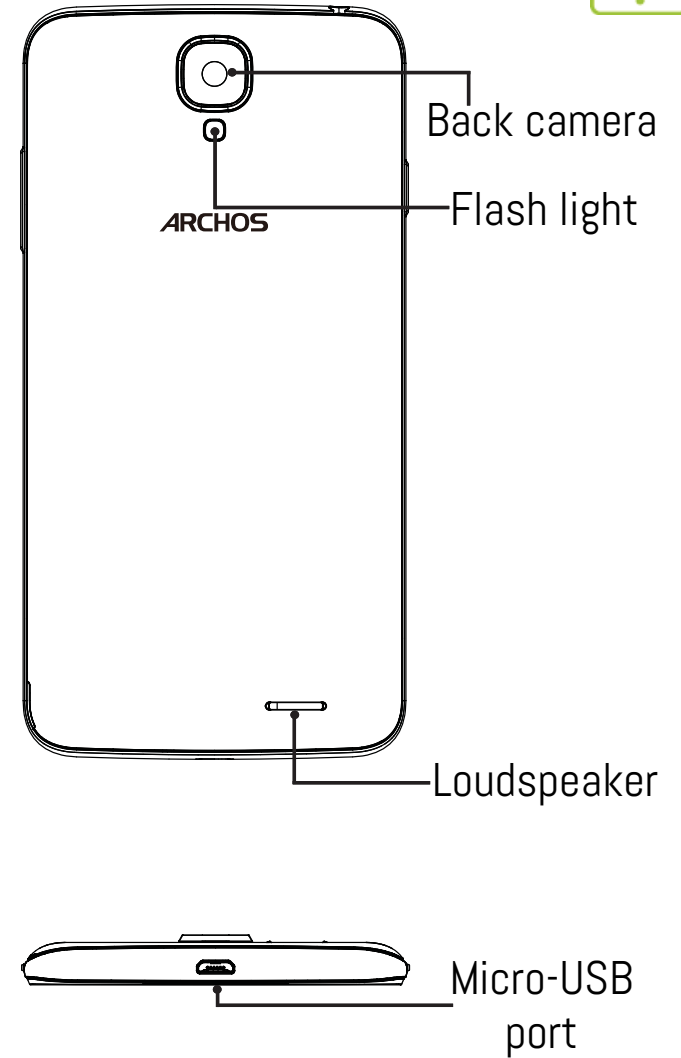
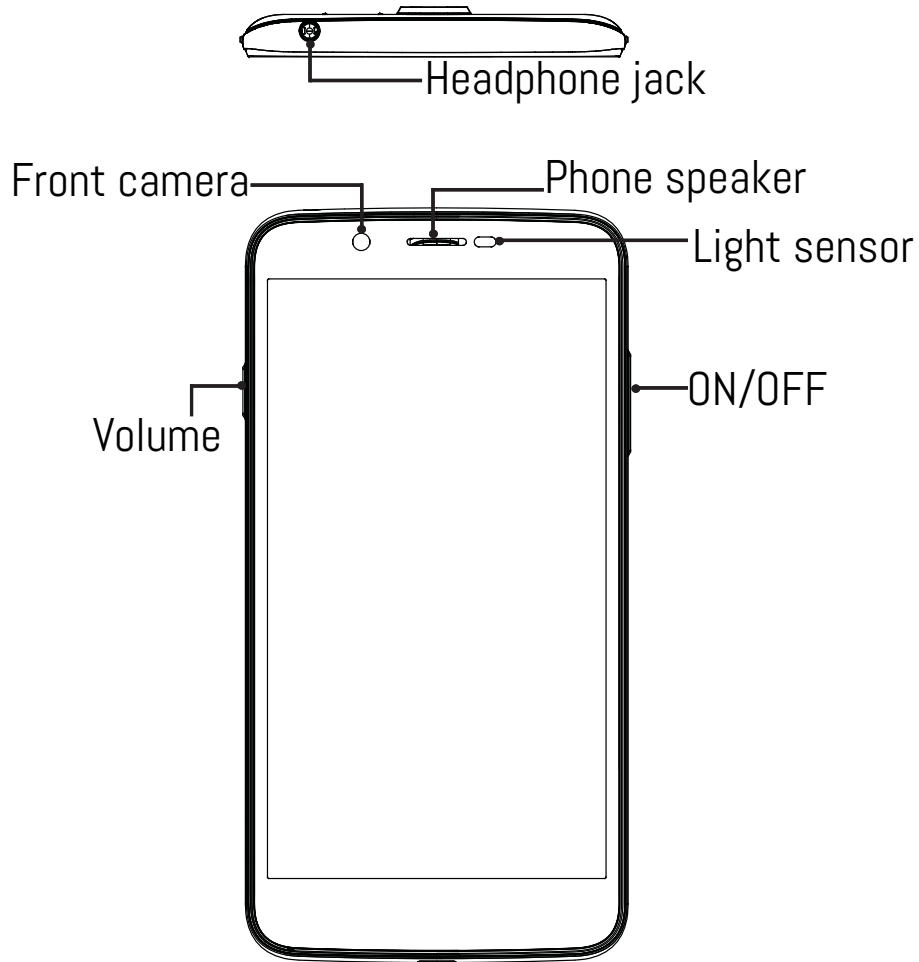



Assembling

After you have unpacked your mobile phone box:

1. Remove the device's back cover using the notch.
2. Insert your SIM card or Memory card in the corresponding slot.
3. Insert the device's battery.
4. Replace the back cover.

4G	slot 1	Micro-SIM
3G/2G	slot 2	Mini SIM
Micro-SD card	slot 3	

When inserting your SIM card or micro-SD card, make sure to follow the illustration, otherwise you may damage the slot or the card.

THE MINI SIM SLOT IS BELOW THE MICRO-SIM SLOT.

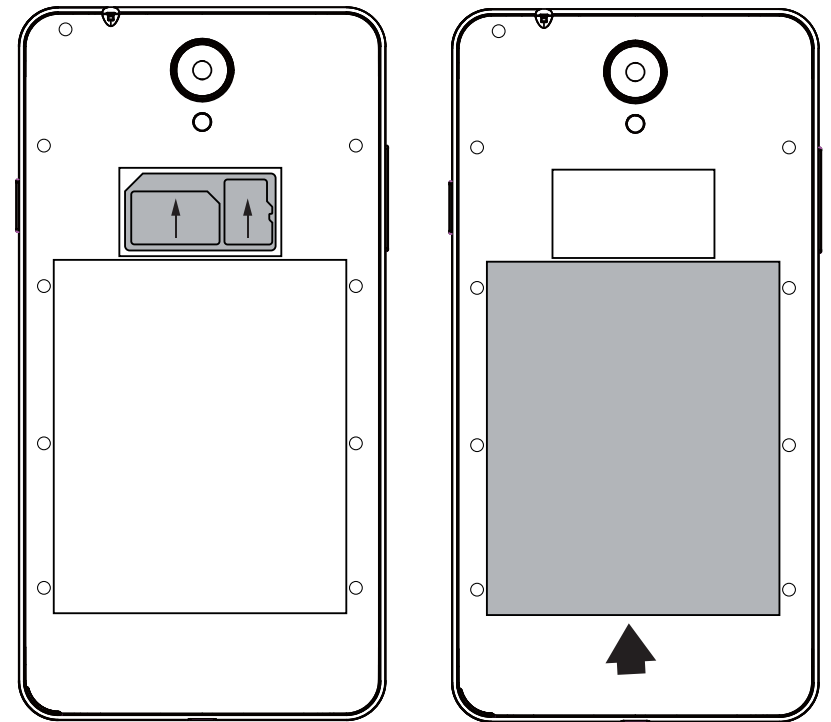
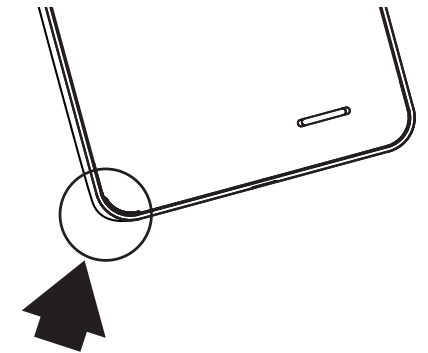



Charging your battery completely

Plug the charging cable in the Micro-USB port and the adapter in a power outlet. Leave the device until the battery is fully charged.



Turning ON

1. Press and hold the ON/OFF button to turn on the device.
2. Follow the instructions to set up your device.

Activating mobile data connection (3G)

1. Touch and pull down the status bar to display it.
2. Touch again the bar to reveal the quick settings.
3. Select the Settings icon.
4. In Wireless & networks, select Data usage, then the SIM card tab.
5. Slide the Mobile data switch to turn on/off.

Activating WiFi connection

1. Touch and pull down the status bar to display it.
2. Touch again the bar to reveal the quick settings.
3. Select the WiFi icon  to activate the WiFi connection .
4. Select "WiFi" below the WiFi icon.
5. Touch the name of network you want to connect to.

Private networks are shown with a lock icon and will require you to enter your password.





Troubleshooting

- My device is frozen: press the ON/OFF button for more than 10 seconds or remove and replace the battery, then turn on the device.
- My device encounters dysfunctions: go to Settings > About phone > Check for update system to check for updates. If your device is up-to-date, try to reset the device from Settings > Factory data reset > Backup & restore. We recommend to save your files before resetting.
- My WiFi reception is too low: make sure you are not far from the WiFi hotspot. Update the firmware of the device: <http://www.archos.com/support>. Reset and redefine your connection parameters. Contact your WiFi connection provider.
- My device bootlogo is playing in a loop: you need to completely reset your device. Go to faq.archos.com and select your device. In Backup & Recovery, select How to reinitialize my ARCHOS.

FOR MORE ANSWERS ABOUT YOUR TECHNICAL DIFFICULTIES, DO NOT HESITATE TO VISIT: FAQ.ARCHOS.COM



Félicitations! Vous venez d'acquérir un appareil ARCHOS! Ce guide de démarrage rapide vous aide à bien débuter l'usage de votre appareil. Si vous avez d'autres questions sur l'usage de votre appareil, visitez nos liens ci-dessous :



twitter.com/archos



www.facebook.com/archos

Blog

<https://blog.archos.com/>



<http://faq.archos.com/>



www.archos.com, click Support > After-sales support



www.archos.com, cliquez Support > Téléchargements > Déclaration de conformité

Comme nous mettons à jour et améliorons régulièrement nos produits, le logiciel de votre appareil peut présenter une interface ou des fonctionnalités légèrement différentes de celles décrites dans ce guide.



Déballage

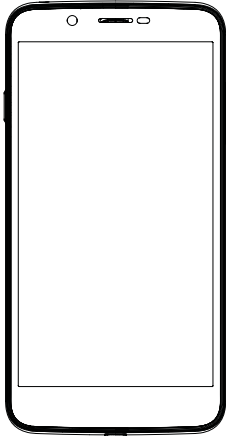

ARCHOS 55 Helium



Livret des garanties et des
mentions légales et sécuritaires

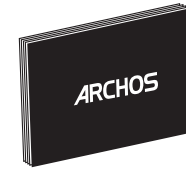

Guide d'utilisation rapide



Adaptateur

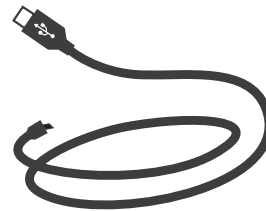

Câble de charge

Description de l'appareil

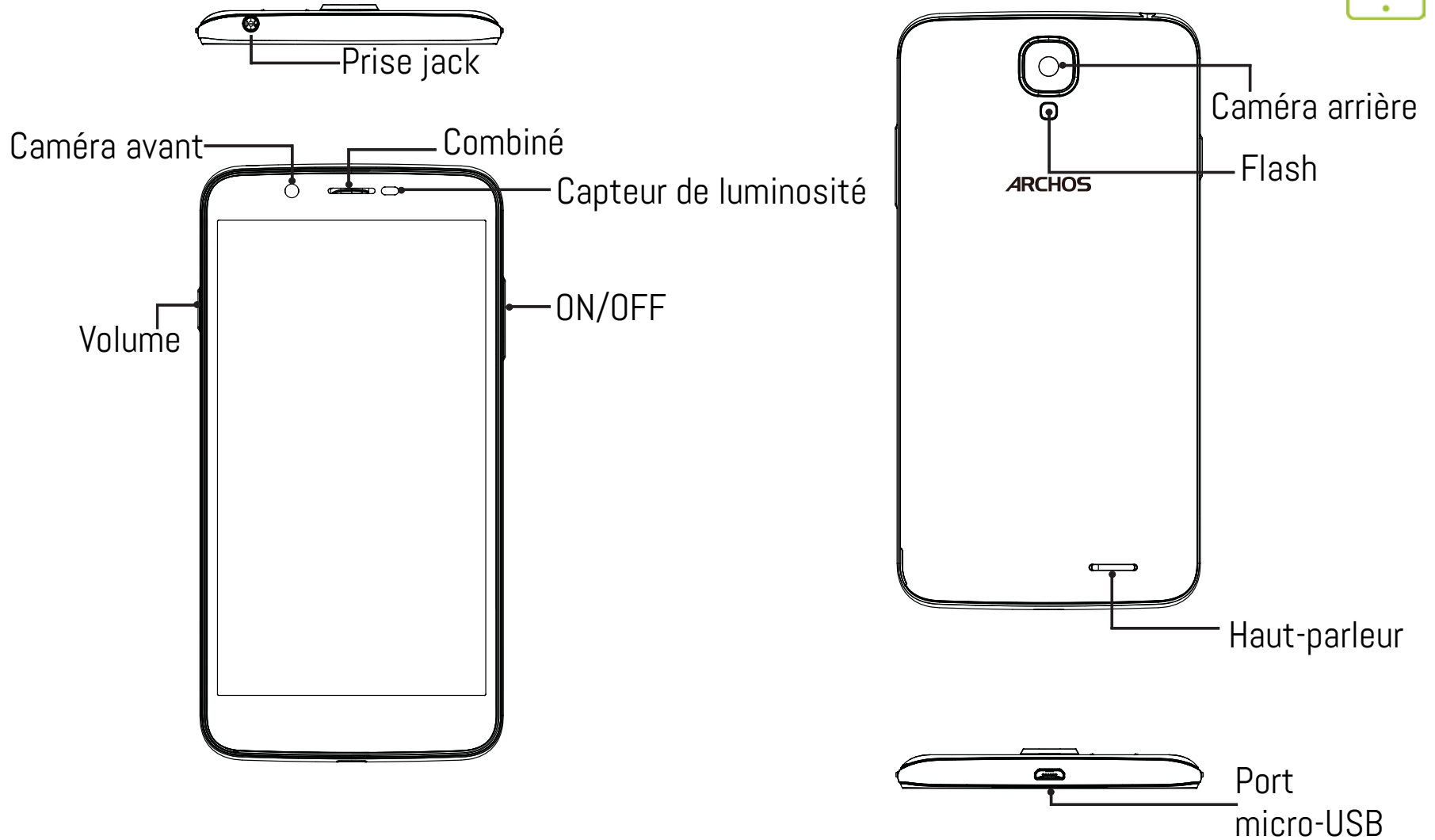



Insertion de cartes et de la batterie

Après avoir déballé le téléphone :

1. Enlevez la coque arrière en utilisant l'encoche.
2. Insérez votre carte SIM ou carte mémoire dans l'emplacement correspondant.
3. Insérez la batterie dans le téléphone.
4. Remettez en place la coque arrière.

4G	emplacement 1	Micro-SIM
3G/2G	emplacement 2	Mini SIM
Carte micro-SD	emplacement 3	

Lorsque vous insérez une carte SIM ou une carte micro-SD, conformez-vous au schéma pour ne pas endommager la carte ou l'emplacement.

L'EMPLACEMENT MINI SIM EST SITUÉ EN-DESSOUS DE L'EMPLACEMENT MICRO-SIM.

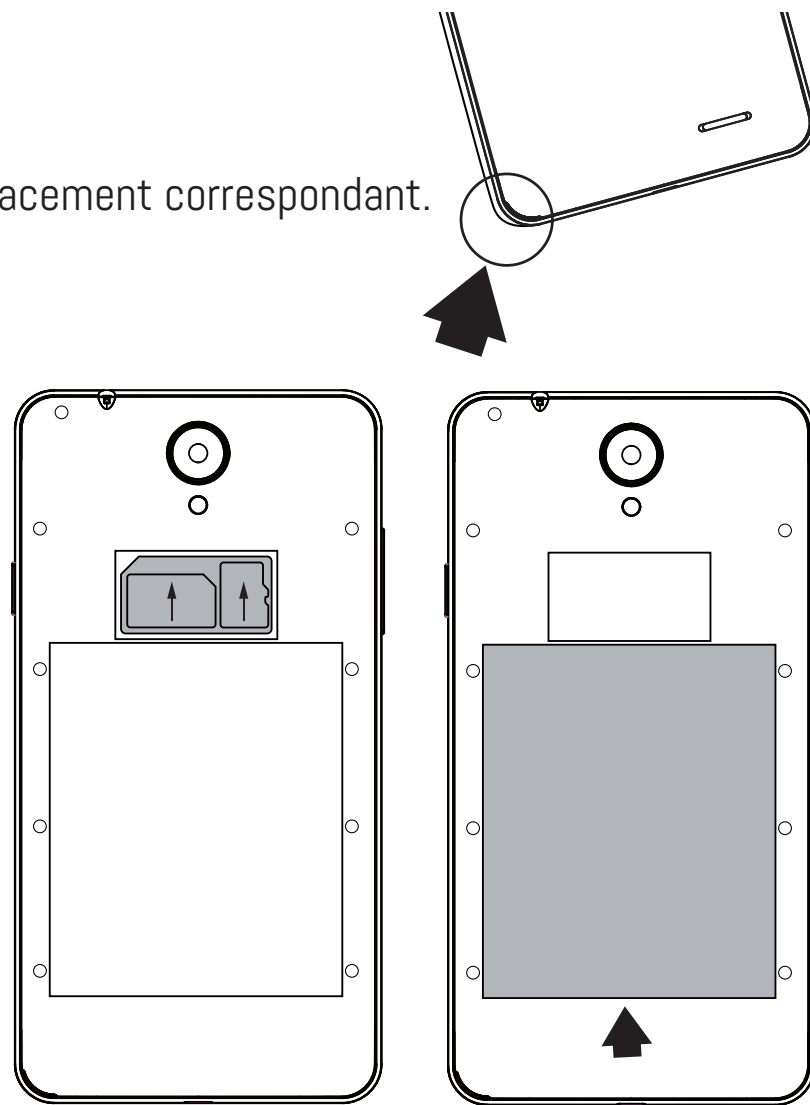



Charger la batterie

Branchez le câble de chargement dans le port micro-USB et connectez-le à son chargeur. Avant la première utilisation, chargez complètement la batterie.



Allumer l'appareil

1. Maintenez le bouton ON/OFF pour allumer l'appareil.
2. Suivez les instructions à l'écran.

Activer la connexion données mobiles (3G)

1. Tirez vers le bas la barre de statuts afin de l'afficher.
2. Une fois affichée, touchez-la à nouveau pour accéder aux réglages rapides.
3. Sélectionnez l'icône Paramètres.
4. Dans la section "Sans fil et réseaux", sélectionnez "Consommation de données", puis l'onglet de la carte SIM.
5. Faites glisser l'interrupteur Données mobiles pour activer/désactiver.

Activer la connexion WiFi

1. Tirez vers le bas la barre de statuts afin de l'afficher.
2. Une fois affichée, touchez-la à nouveau pour accéder aux réglages rapides.
3. Sélectionnez l'icône WiFi  pour activer la connexion .
4. Sélectionnez "WiFi" en bas de l'icône WiFi.
5. Sélectionnez le nom du réseau auquel vous voulez vous connecter. Les réseaux privés sont affichés avec un cadenas. Ils nécessitent un mot de passe.





Dépannage

- Mon téléphone ne répond pas: appuyez 10 secondes sur le bouton ON/OFF ou enlevez la batterie et remettez-la en place, puis rallumez l'appareil.
- Mon téléphone rencontre des problèmes : allez dans paramètres > A propos du téléphone > mise à jour pour voir si aucune mise à jour n'est disponible. Si votre appareil est à jour, procédez donc à une réinitialisation complète à partir de paramètres > sauvegarde et réinitialisation. N'oubliez pas de sauvegarder vos fichiers avant la réinitialisation complète.
- Votre connexion WiFi est très faible : assurez-vous de ne pas être trop loin de la borne WiFi. Veuillez mettre à jour votre produit si nécessaire. Paramétrez à nouveau votre connexion. Contactez votre fournisseur d'accès.
- Le logo de démarrage tourne en boucle : vous devez réinitialiser complètement votre appareil. Allez sur faq.archos.com et sélectionnez votre appareil. Dans Sauvegarde & réinitialisation, sélectionnez Comment réinitialiser mon ARCHOS.

POUR PLUS DE RENSEIGNEMENTS SUR VOS PROBLÈMES TECHNIQUES, N'HÉSITEZ PAS À CONSULTER LA PAGE : FAQ.ARCHOS.COM



Vielen Dank, dass Sie sich für ein ARCHOS-Gerät entschieden haben! Diese Schnellstartanleitung wird Sie bei der ordnungsgemäßen Bedienung Ihres Geräts unterstützen. Falls Sie bezüglich der Bedienung Ihres Geräts weitere Fragen haben, besuchen Sie uns unter:



twitter.com/archos



www.facebook.com/archos



<https://blog.archos.com/>



<http://faq.archos.com/>



www.archos.com, klicken Sie auf Support > After-Sales-Support



www.archos.com, klicken Sie auf Support > Downloads > Konformitätserklärung

Da unsere Produkte kontinuierlich aktualisiert und weiterentwickelt werden, kann die Software Ihres Geräts in Erscheinung und Funktionalität geringfügige Abweichungen zu den Darstellungen in dieser Schnellstartanleitung aufweisen.



Verpackungsinhalt

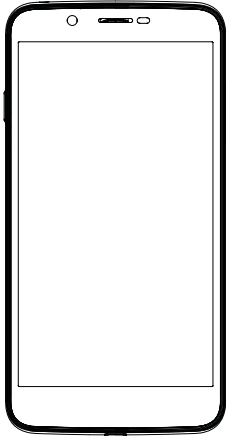

ARCHOS 55 Helium



Garantie, Impressum und
Sicherheitshinweise

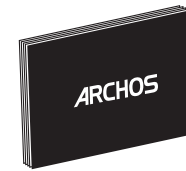

Benutzerhandbuch

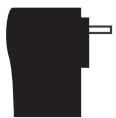

Lade-/Netzgerät

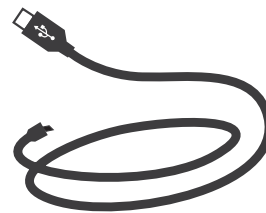

Ladekabel

Beschreibung des Geräts

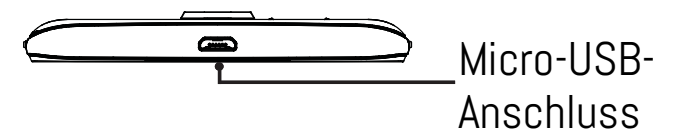
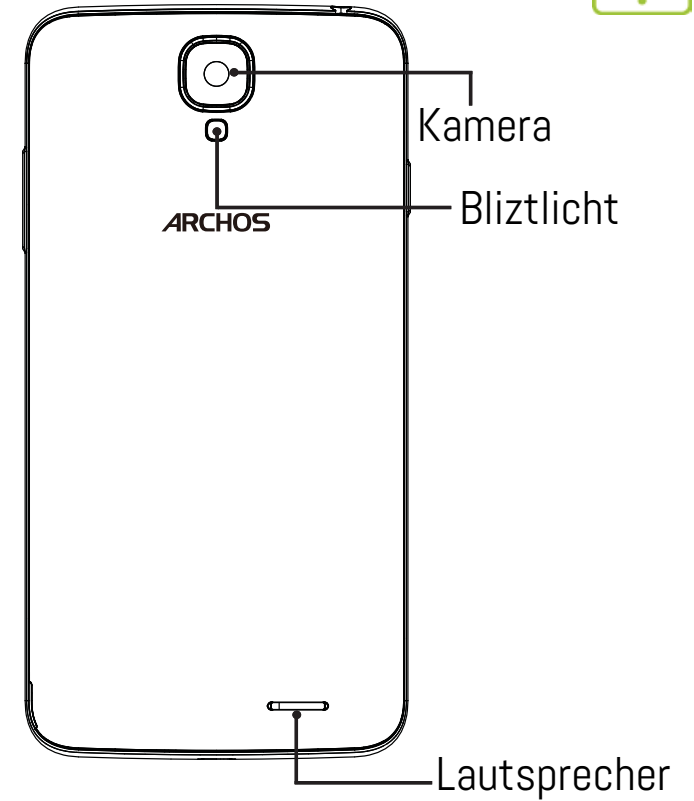
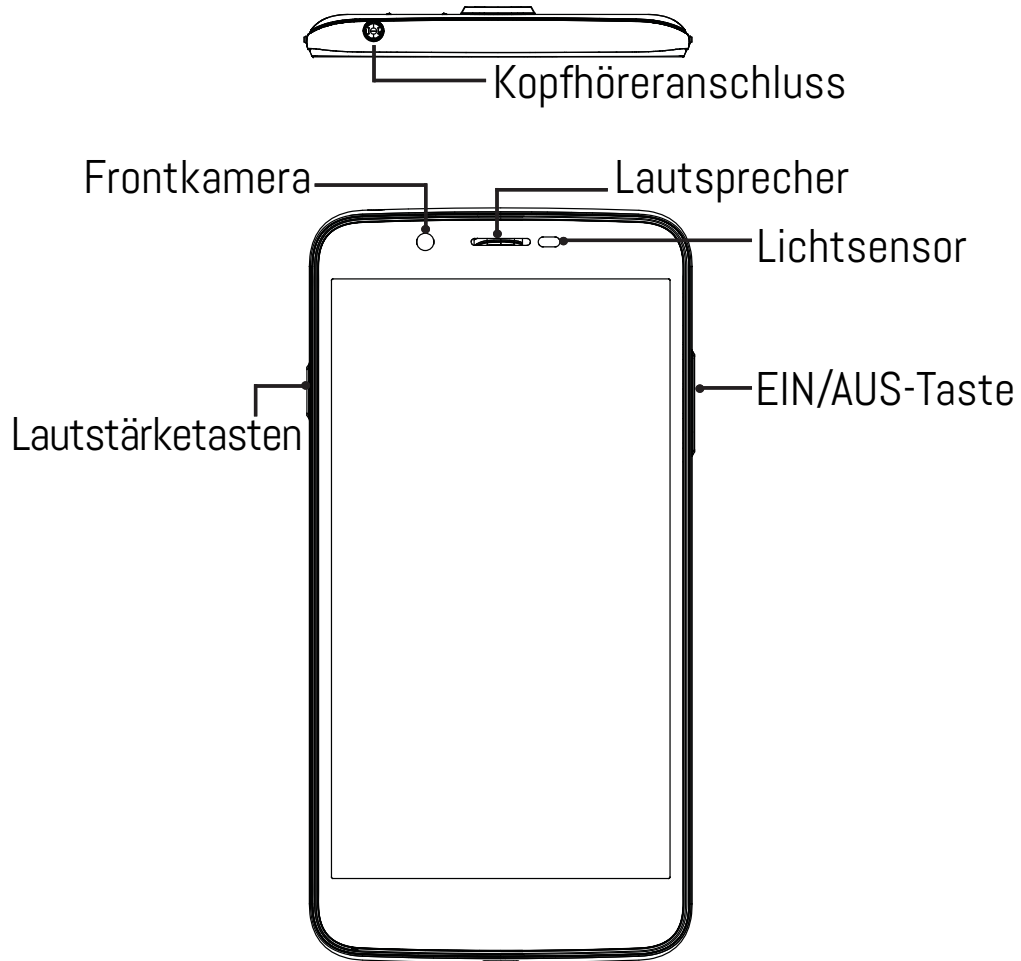



Montage

Nach dem Auspacken des Mobiltelefons:

1. Heben Sie die Rückabdeckung des Geräts mithilfe der Einkerbung an.
2. Stecken Sie eine SIM-Karte oder micro-SD-Karte in den entsprechenden Steckplatz ein.
3. Legen Sie den Akku des Geräts ein.
4. Bringen Sie die Rückabdeckung wieder an.

4G	1	Micro-SIM
3G/2G	2	Mini SIM
micro-SD-Karte	3	

Beachten Sie beim Einführen der SIM-Karte oder micro-SD-Karte unbedingt die Illustration, der Steckplatz oder die Karte könnten sonst beschädigt werden.
DER MINI SIM SLOT IST UNTER DEN MICRO-SLOT.

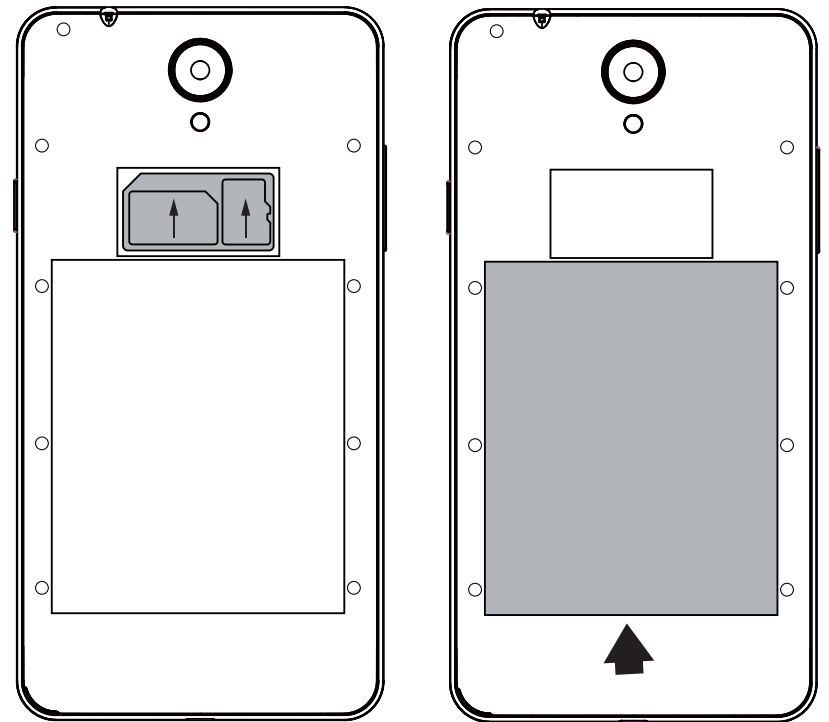
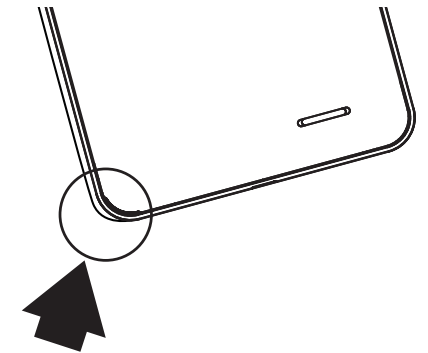



Aufladen des Akkus

Stecken Sie das Ladekabel in den Micro-USB-Anschluss und verbinden Sie es mit dem Ladegerät. Vor der erstmaligen Benutzung des Geräts sollte der Akku vollständig aufgeladen werden.



Einschalten

1. Drücken und halten Sie die EIN/AUS-Taste, um das Gerät einzuschalten.
2. Folgen Sie den Anweisungen.

Activating mobile data connection (3G)

1. Die Statusleiste berühren und nach unten ziehen, um diese anzuzeigen.
2. Die Leiste erneut berühren, um die Schnelleinstellungen anzuzeigen.
3. Wählen Sie das Symbol "Einstellungen".
4. Unter "WLAN & Netzwerke" wählen Sie "Datennutzung" und dann die Registerkarte "SIM-Karte".
5. Schieben Sie den Schalter "Mobilfunkdaten" auf Ein/Aus.

Activating WiFi connection

1. Die Statusleiste berühren und nach unten ziehen, um diese anzuzeigen.
 2. Die Leiste erneut berühren, um die Schnelleinstellungen anzuzeigen.
 3. Wählen Sie das WLAN-Symbol  zur Aktivierung der WLAN-Verbindung .
 4. Wählen Sie "WLAN" unter dem WLAN-Symbol.
 5. Tippen Sie auf den Namen des Netzwerks, mit dem eine Verbindung hergestellt werden soll.
- Private Netzwerke werden mit einem Schlosssymbol angezeigt und hier muss das Passwort eingegeben werden





Fehlerbehebung

- Mein Gerät ist abgestürzt: Halten Sie die EIN/AUS-Taste mindestens 10 Sekunden lang gedrückt oder entnehmen Sie den Akku und setzen Sie wieder ein und starten Sie das Gerät.
- Mein Telefon hat Probleme: Gehen Sie zu Einstellungen > Telefoninfo > Update, um zu sehen, ob Updates verfügbar sind. Wenn Ihr Gerät auf dem neuesten Stand ist, führen Sie so einen Hard-Reset über Einstellungen > Sichern und zurücksetzen. Denken Sie daran, Ihre Dateien vor dem vollständigen Reset sichern.
- Bei zu schwachem WLAN-Empfang: Vergewissern Sie sich, dass Sie nicht zu weit vom WLAN-Hotspot entfernt sind. Aktualisierung der Gerätefirmware: <http://www.archos.com/support>. Setzen Sie die Verbindungsparameter zurück und definieren Sie sie neu. Wenden Sie sich an Ihren Internetanbieter.
- Das Boot-Logo in einer Schleife: Sie müssen Ihr Gerät komplett zurückgesetzt. Gehen Sie faq.archos.com und wählen Sie Ihr Gerät. In Backup & Reset, wählen Sie Wie mein ARCHOS zurücksetzen.

WEITERE ANTWORTEN BEI TECHNISCHEN PROBLEMEN FINDEN SIE UNTER: FAQ.ARCHOS.COM



¡Felicidades por la compra de su dispositivo ARCHOS! La guía rápida de inicio le ayudará a utilizar su dispositivo de forma correcta. Si tiene cualquier duda acerca de la utilización de su dispositivo, entre en:



twitter.com/archos



www.facebook.com/archos



<https://blog.archos.com/>



<http://faq.archos.com/>



www.archos.com, haga clic en Support (Asistencia) > After-sales support (Asistencia posventa)



www.archos.com, haga clic en Support (Asistencia) > Downloads (Descargas) > Declaration of conformity (Declaración de conformidad)

Al estar actualizando y mejorando constantemente nuestros productos, la apariencia o el software de su dispositivo pueden variar ligeramente con respecto a lo descrito en esta Guía Rápida de Inicio.



Contenido de la caja

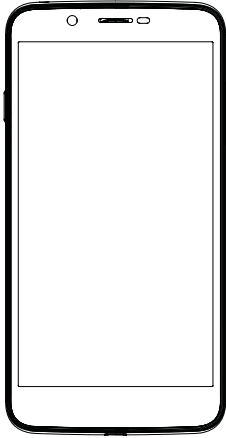

ARCHOS 55 Helium



Avisos de garantía, legales y de seguridad

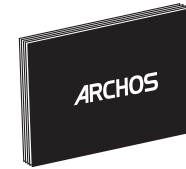

Guía de usuario

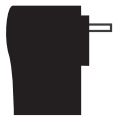

Adaptador/cargador

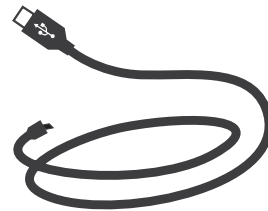

Cable de carga

Descripción de su dispositivo

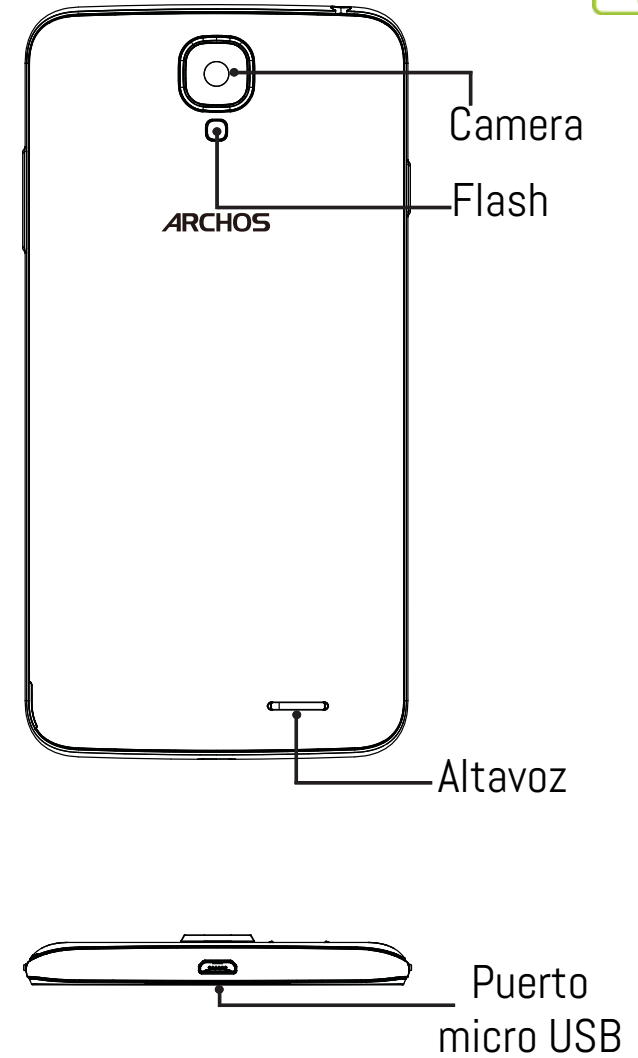
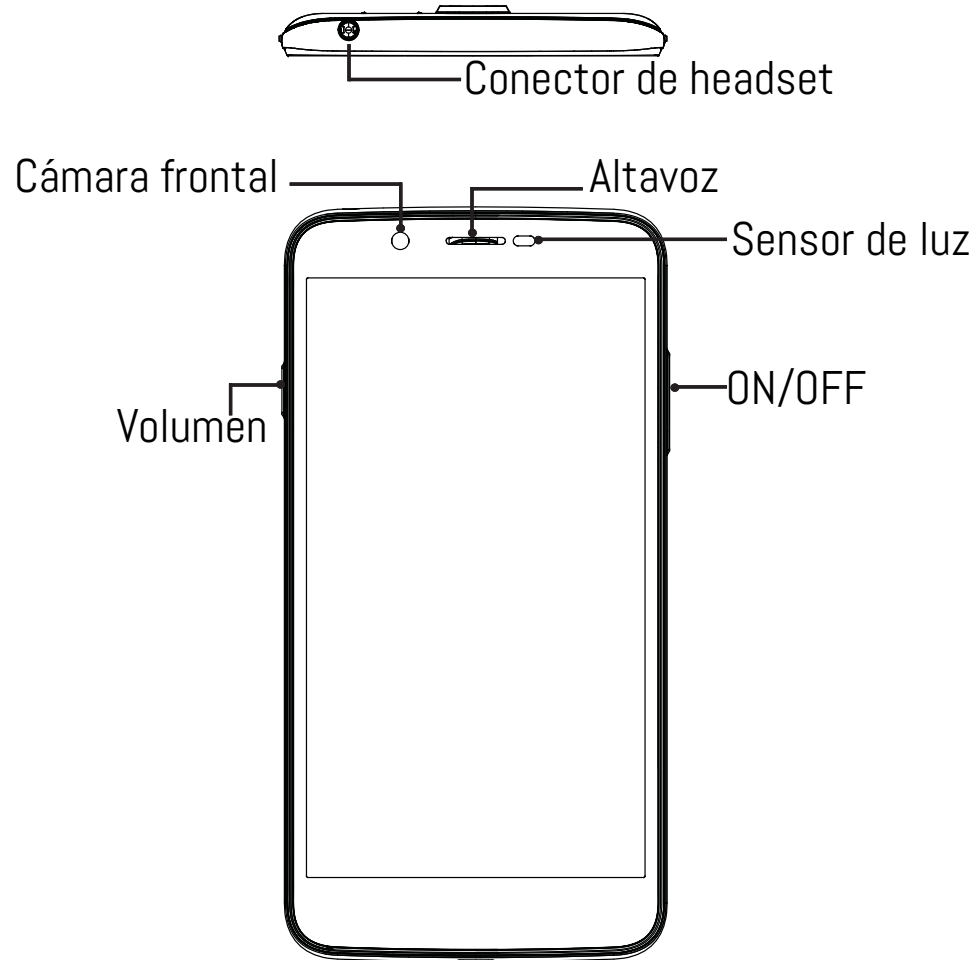



Montaje

Una vez el teléfono móvil fuera de su caja:

1. Retire la cubierta posterior del dispositivo utilizando la muesca.
2. Inserte su tarjeta SIM o micro SD en la ranura correspondiente.
3. Inserte la batería del dispositivo.
4. Vuelva a colocar la cubierta posterior.

4G	1	Micro-SIM
3G/2G	2	Mini SIM
Micro-SD card	3	

Al insertar una tarjeta SIM o una tarjeta micro SD, asegúrese de hacerlo conforme a la ilustración, de lo contrario podría dañar la ranura o la tarjeta.
LA RANURA MINI SIM ESTÁ POR DEBAJO DE LA RANURA DE MICRO-SIM

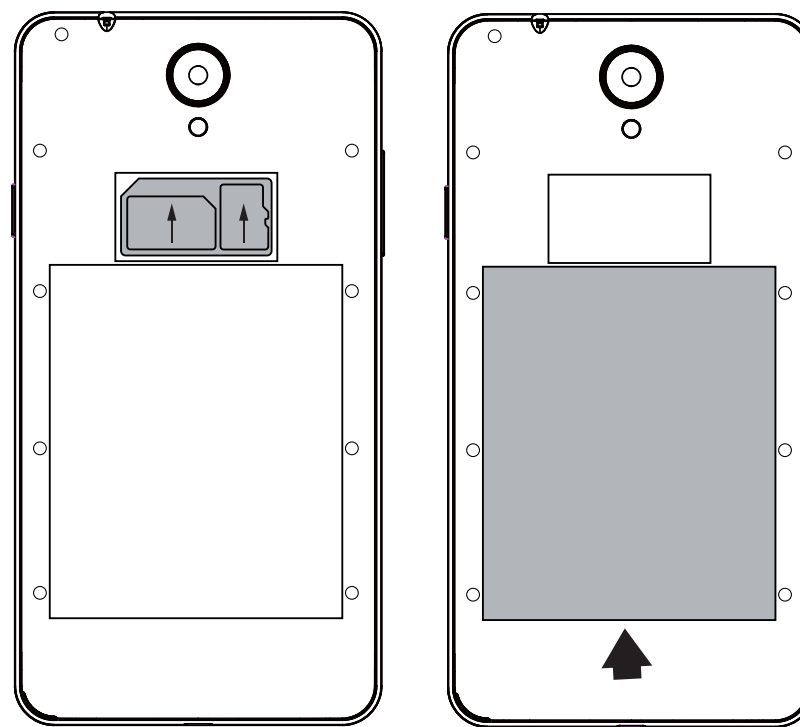
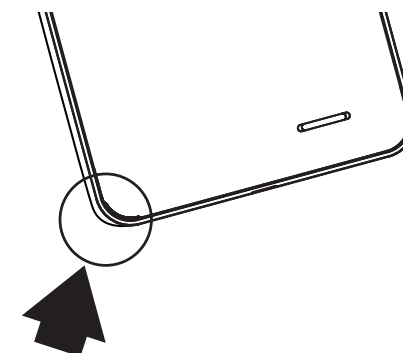

Antes de empezar



Cargado de la batería

Enchufe el cable de carga al puerto micro USB y conéctelo al cargador.

Antes de utilizar el dispositivo por primera vez, cargue completamente la batería.



Encendido

1. Mantenga pulsado el botón ON/OFF para encender el dispositivo.
2. Siga las instrucciones.

Activación de los datos móviles (3G)

1. Toque y arrastre hacia abajo la barra de estado para mostrarla.
2. Vuelva a tocar la barra para mostrar los ajustes rápidos.
3. Seleccione el icono de Ajustes.
4. En Conexiones inalámbricas y redes, seleccione Uso de datos, y luego la pestaña de la tarjeta SIM.
5. Deslice el interruptor de Datos móviles para activarlo o desactivarlo.

Conexión WiFi

1. Toque y arrastre hacia abajo la barra de estado para mostrarla.
2. Vuelva a tocar la barra para mostrar los ajustes rápidos.
3. Seleccione el icono WiFi  para activar la conexión WiFi .
4. Seleccione "WiFi" bajo el icono WiFi.
5. Toque el nombre de la red a la que se desee conectar.

Las redes privadas aparecen con un icono de candado, lo que significa que deberá introducir una contraseña.





Resolución de problemas

- Mi teléfono está bloqueado: pulse el botón ON / OFF durante 10 segundos o quitar la batería y ponerla en su sitio
- El dispositivo se encuentra con disfunciones: Vaya a Ajustes> Acerca del teléfono> Consultar la actualización del sistema para comprobar si hay actualizaciones. Si el dispositivo es de hasta al día, trate de reiniciar el dispositivo de Configuración> Restablecer datos de fábrica> Copia de seguridad y restauración. Recomendamos guardar sus archivos antes de restaurar.
- Si la recepción WiFi es demasiado débil: acérquese más al punto de acceso WiFi. Actualice el firmware del dispositivo: <http://www.archos.com/support>. Restablezca y vuelva a configurar sus parámetros de conexión. Póngase en contacto con su proveedor de servicios WiFi.
- Mi bootlogo dispositivo está jugando en un bucle: tendrá que restablecer completamente su dispositivo. Ir a faq.archos.com y seleccione su dispositivo. En Backup & Recovery, seleccione Cómo reinicializar mis ARCHOS.

PARA RESOLVER CUALQUIER INCIDENCIA TÉCNICA, NO DUDE EN VISITAR: FAQ.ARCHOS.COM



Congratulazioni per aver acquistato un dispositivo ARCHOS. La presente guida rapida supporta l'utente nel corretto utilizzo del dispositivo. Per ulteriori dettagli sull'uso del dispositivo, visitare:



twitter.com/archos



www.facebook.com/archos

Blog

<https://blog.archos.com/>



<http://faq.archos.com/>



www.archos.com, fai clic su Assistenza > Supporto post vendita



www.archos.com, fai clic Assistenza > Download > Dichiarazione di conformità

Poiché aggiorniamo e miglioriamo con frequenza i nostri prodotti, il software del dispositivo potrebbe avere un aspetto leggermente differente o funzionalità modificate rispetto a quelle mostrate nella presente Guida rapida.



Contenuto della confezione

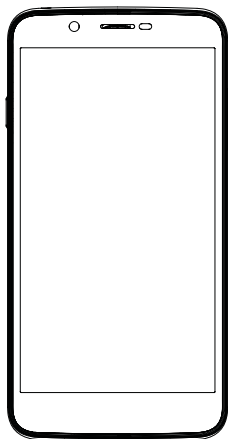

ARCHOS 55 Helium



Garanzia, note legali e sulla sicurezza

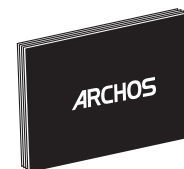

Guida dell'utente

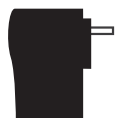

Caricabatterie

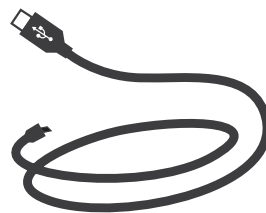

Cavo di caricamento

Descrizione del dispositivo

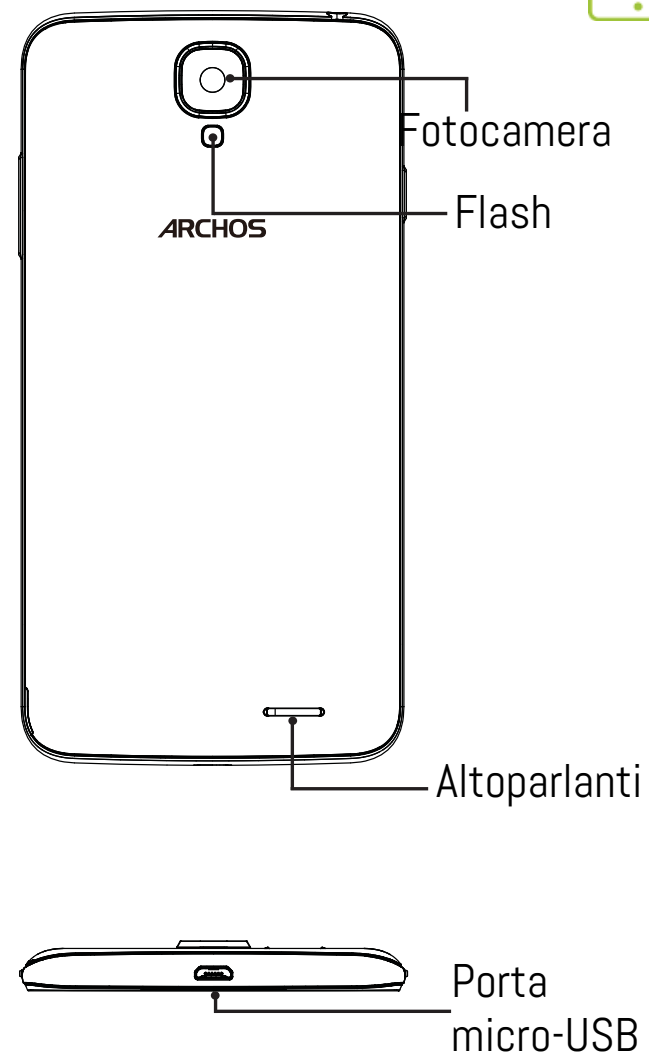
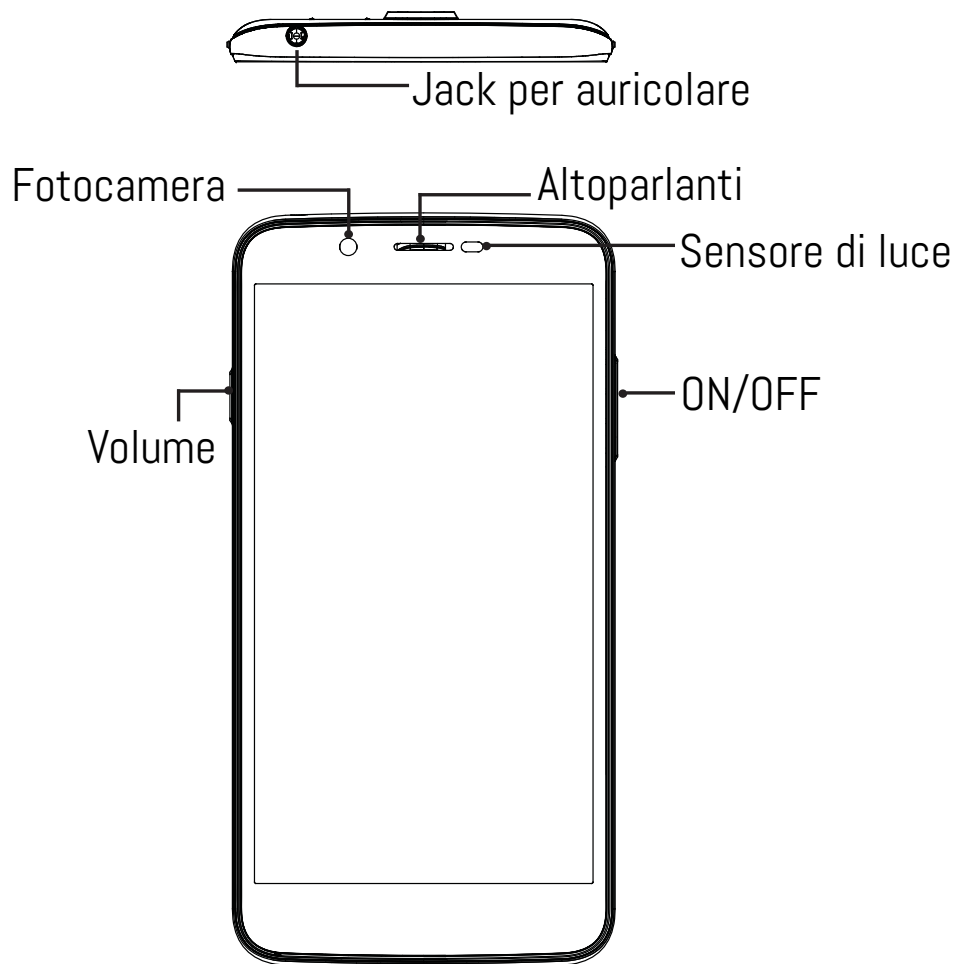



Assemblaggio

Dopo aver estratto dalla confezione il telefono cellulare:

1. Rimuovere la copertura posteriore del dispositivo utilizzando il foro.
2. Inserire la scheda SIM o scheda micro-SD nello slot corrispondente.
3. Inserire la batteria del dispositivo.
4. Riposizionare la copertura posteriore.

4G	1	Micro-SIM
3G/2G	2	Mini SIM
scheda micro-SD	3	

Quando si inserisce la scheda SIM o la scheda micro-SD, assicurarsi di seguire quanto illustrato per evitare di danneggiare lo slot o la scheda.
LO SLOT MINI SIM È SOTTO LO SLOT MICRO-SIM.

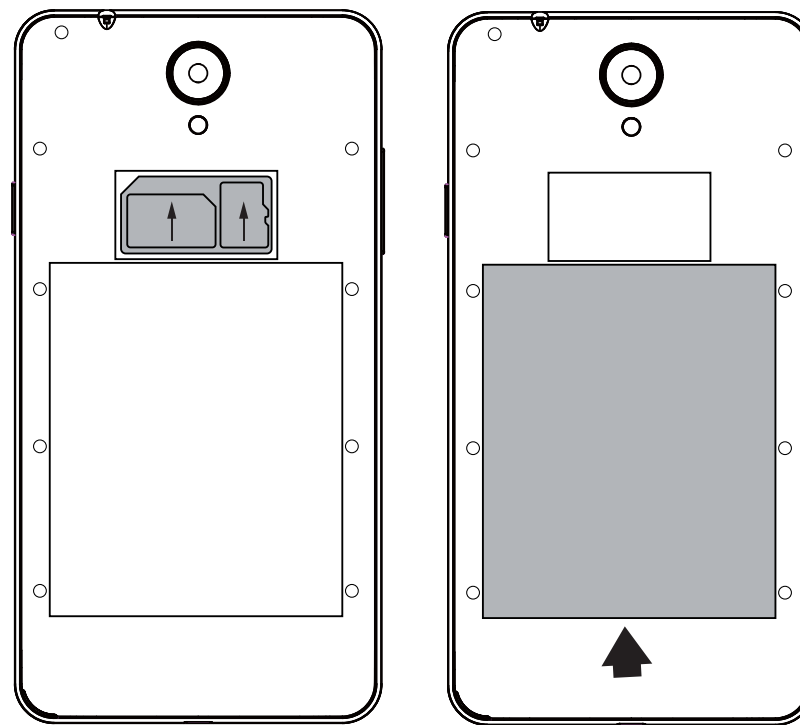
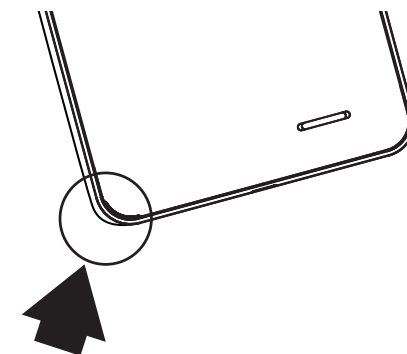



Caricamento della batteria

Inserire il cavo di ricarica nella porta micro-USB e collegarlo al caricabatterie. Prima di utilizzare il dispositivo per la prima volta, caricare completamente la batteria.



Accensione

1. Tenere premuto il pulsante ON/OFF per accendere il dispositivo.
2. Seguire le istruzioni.

Connessione dati (3G)

1. Toccare e tirare verso il basso la barra di stato per visualizzarla.
2. Toccare di nuovo la barra per visualizzare le impostazioni rapide.
3. Selezionare l'icona "Settings" [Impostazioni].
4. In Wireless e reti, selezionare Uso dati, quindi la scheda della SIM card.
5. Scorrere il dito per attivare/disattivare l'opzione Connessione dati.

Connessione Wi-Fi

1. Toccare e tirare verso il basso la barra di stato per visualizzarla.
2. Toccare di nuovo la barra per visualizzare le impostazioni rapide.
3. Selezionare l'icona del Wi-Fi  per attivare la connessione Wi-Fi .
4. Selezionare "Wi-Fi" sotto l'icona del Wi-Fi.
5. Toccare il nome della rete a cui l'utente desidera connettersi.

Le reti private vengono mostrate con un'icona di blocco e richiedono l'inserimento della password.





Risoluzione dei problemi

- Il telefono è bloccato: premere sul pulsante ON/OFF per più di 10 secondi o rimuovere la batteria e rimetterla al suo posto.
- Il dispositivo incontra disfunzioni: andare a Impostazioni > Info sul telefono > Verifica per il sistema di aggiornamento per controllare gli aggiornamenti. Se il dispositivo è up-to-date, cercare di ripristinare il dispositivo da Impostazioni > Ripristino dati di fabbrica > Backup e ripristino. Si consiglia di salvare i file prima di resettare.
- Se la connessione Wi-Fi è troppo lenta: assicurarsi di trovarsi in prossimità dell'hotspot Wi-Fi. Aggiornare il firmware del dispositivo: <http://www.archos.com/support>. Ripristinare e ridefinire i parametri della connessione. Contattare il provider della connessione Wi-Fi.
- Il mio bootlogo dispositivo sta giocando in un ciclo: è necessario ripristinare completamente il dispositivo. Vai a faq.archos.com e selezionare il dispositivo. In Backup & Recovery, selezionare Come reinizializzare miei ARCHOS.

PER ULTERIORI SOLUZIONI RELATIVE A PROBLEMI TECNICI, VISITARE: FAQ.ARCHOS.COM



Gefeliciteerd met de aanschaf van uw ARCHOS-apparaat! Met behulp van de verkorte handleiding kunt u meteen aan de slag. Als u nog vragen heeft over het gebruik van het apparaat, ga dan naar:



twitter.com/archos



www.facebook.com/archos

Blog

<https://blog.archos.com/>



<http://faq.archos.com/>



www.archos.com, klik op Support > After-sales support



www.archos.com, click Support > Downloads > Declaration of conformity
[Conformiteitsverklaring]

Aangezien wij onze producten regelmatig updaten en verbeteren, kunnen de afbeeldingen en/of de functies van uw apparaatsoftware afwijken van de software in deze Verkorte handleiding.



Uitpakken

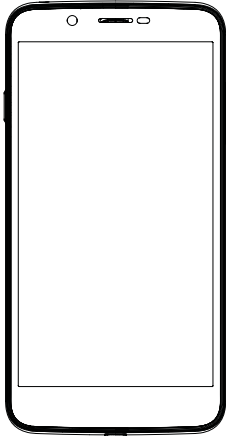

ARCHOS 55 Helium



Garantie, wettelijke mededelingen
en veiligheidsvoorschriften

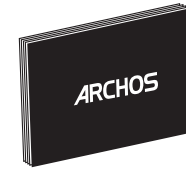

Gebruikershandleiding



Oplader/adapter

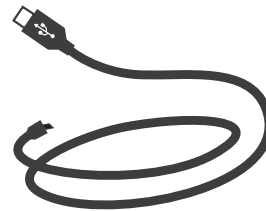

Oplaadkabel

Beschrijving van het apparaat

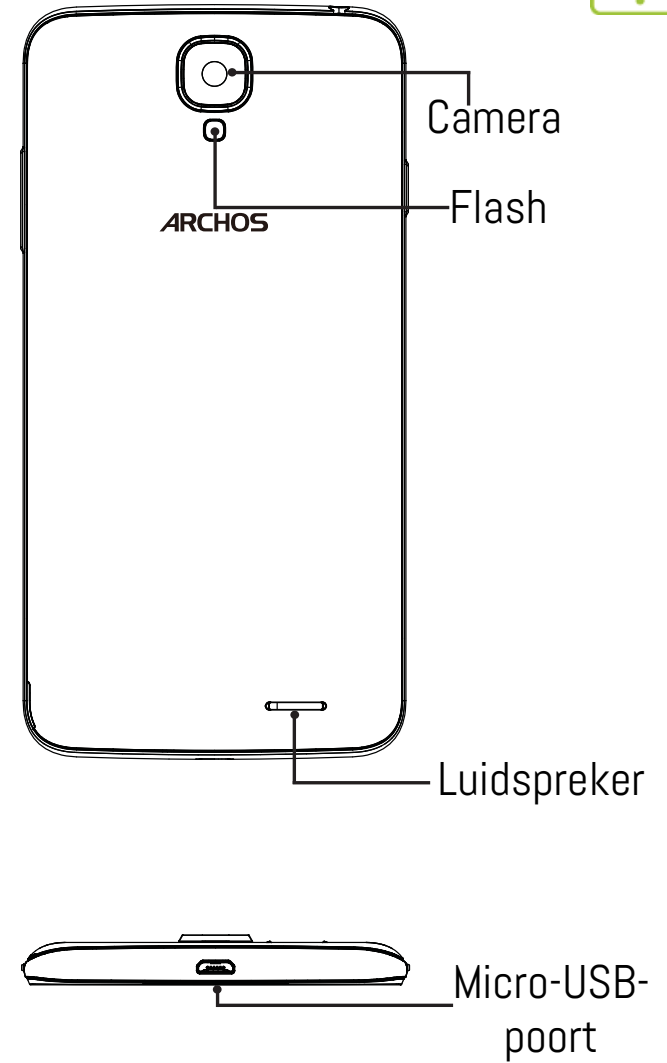
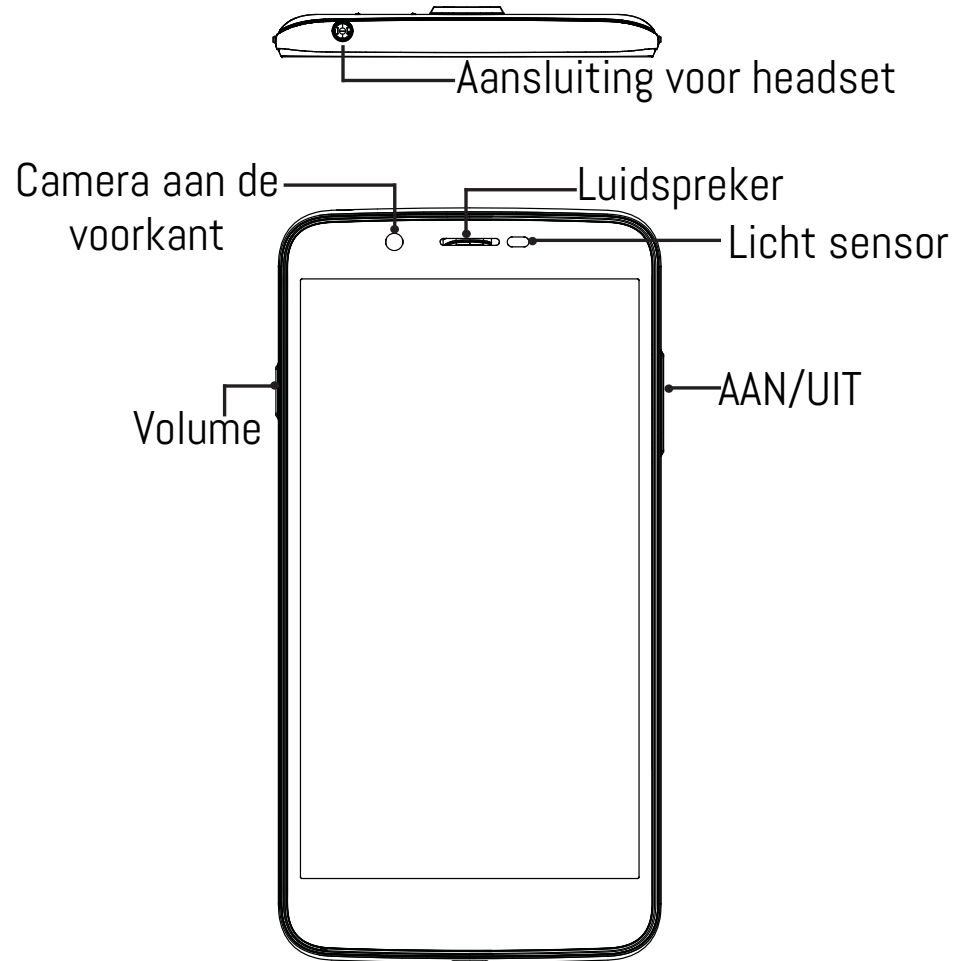



Montage

Na het uitpakken van de mobiele telefoon:

1. Verwijder de achterklep van het apparaat via de inkeping.
2. Plaats de SIM-kaart of micro-SD-kaart in de betreffende sleuf.
3. Plaats de batterij van het apparaat.
4. Plaats de achterklep terug.

4G	1	Micro-SIM
3G/2G	2	Mini SIM
Micro-SD-kaart	3	

Kijk tijdens het plaatsen van een SIM-kaart of micro-SD-kaart goed naar de afbeelding. Anders beschadigt u mogelijk de sleuf of de kaart.
DE MINI SIM SLOT IS ONDER DE MICRO-SIM.

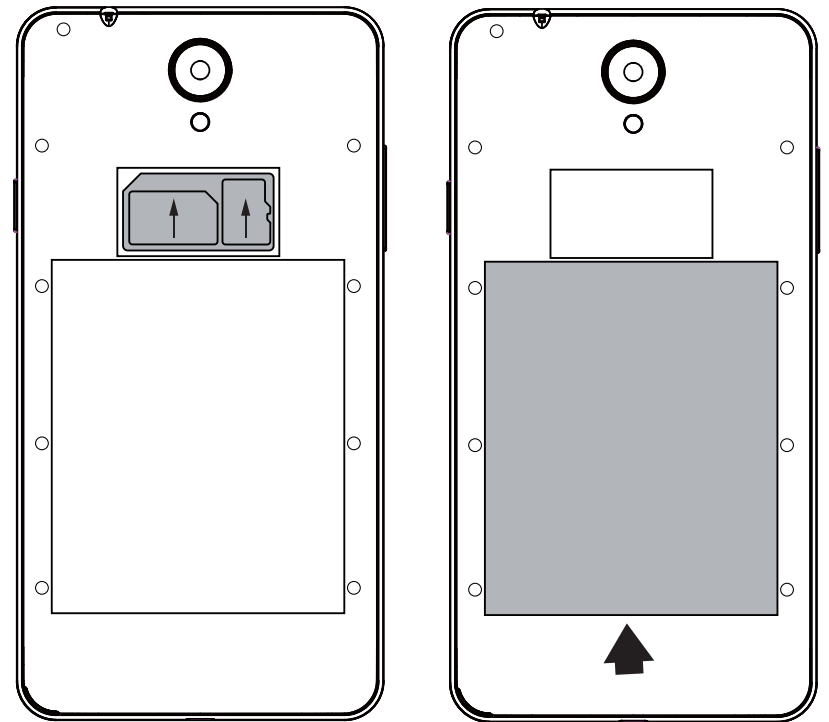
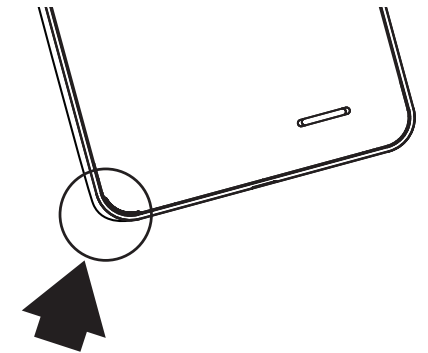



De batterijen laden

Sluit de oplaadkabel aan op de Micro-SB-poort en sluit de kabel aan op de oplader. Voordat u het apparaat gaat gebruiken, moet u eerst de batterij helemaal opladen.

Inschakelen

1. Houd de AAN/UIT-knop ingedrukt om het apparaat in te schakelen.
2. Volg de aanwijzingen.

Mobiele dataverbinding (3G)

1. Trek de statusbalk omlaag om deze weer te geven.
2. Raak de balk nogmaals aan om de snelinstellingen weer te geven.
3. Selecteer het pictogram Settings [Instellingen].
4. Bij Draadloos & Netwerken kiest u Datagebruik en dan de tab Sim-kaart.
5. Verschuif de schakelaar voor mobiele data om in en uit te schakelen.

WiFi-verbinding

1. Trek de statusbalk omlaag om deze weer te geven.
2. Raak de balk nogmaals aan om de snelinstellingen weer te geven.
3. Kies het WiFi-pictogram  om de WiFi-verbinding in te schakelen .
4. Kies "WiFi" onder het WiFi-pictogram.
5. Tik op de naam van het netwerk waarmee u verbinding wilt maken. Privé-netwerken worden weergegeven met een slot-pictogram en vereisen de invoer van een wachtwoord.





Probleemoplossing

- Mijn telefoon doet niets meer: Houd de AAN/UIT-knop langer dan 10 seconden ingedrukt of verwijder de accu en zet hem terug op zijn plaats.
- Mijn toestel ontmoetingen disfuncties: ga naar Instellingen> Over de telefoon> Controleren op update systeem om te controleren op updates. Als uw apparaat up-to-date, proberen om het apparaat te resetten via Instellingen> Terugzetten op fabrieksinstellingen> Backup and Restore. Wij adviseren om uw bestanden op te slaan voordat resetten.
- Als de WiFi-ontvangst zwak is, controleer dan of u niet te ver weg bent van de WiFi-hotspot. Update de firmware van het apparaat: <http://www.archos.com/support>. Reset de verbindingparameters en stel ze opnieuw in. Neem contact op met de provider van uw WiFi-verbinding.
- Mijn toestel Bootlogo speelt in een lus: je nodig hebt om uw apparaat volledig opnieuw in te stellen. Ga naar faq.archos.com en selecteer uw apparaat. In Backup & Recovery, selecteert u Hoe mijn ARCHOS opnieuw te initialiseren.

VOOR MEER ANTWOORDEN OP TECHNISCHE VRAGEN GAAT U NAAR: FAQ.ARCHOS.COM



Obrigado por ter adquirido um dispositivo ARCHOS! Este guia de introdução irá ajudá-lo a utilizar o seu dispositivo corretamente. Caso tenha mais questões sobre como utilizar o seu dispositivo, visite-nos em:



twitter.com/archos



www.facebook.com/archos

Blog

<https://blog.archos.com/>



<http://faq.archos.com/>



www.archos.com, clique em Suporte > Suporte pós-venda



www.archos.com, clique em Suporte > Transferências > Declaração de conformidade

Como estamos constantemente a atualizar e a melhorar os nossos produtos, o software do seu dispositivo poderá ter um aspeto ou funcionalidades ligeiramente diferentes das apresentadas neste guia de introdução.



Desempacotamento

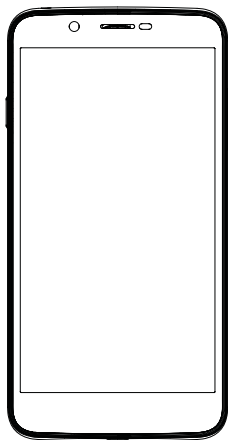

ARCHOS 55 Helium



Garantia, avisos legais e de
segurança

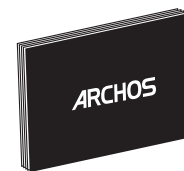

Guia do usuário



Transformador do
carregador

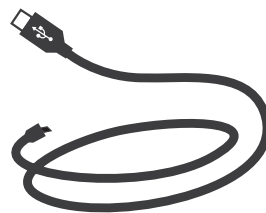

Cabo de carregamento

Descrição do seu dispositivo

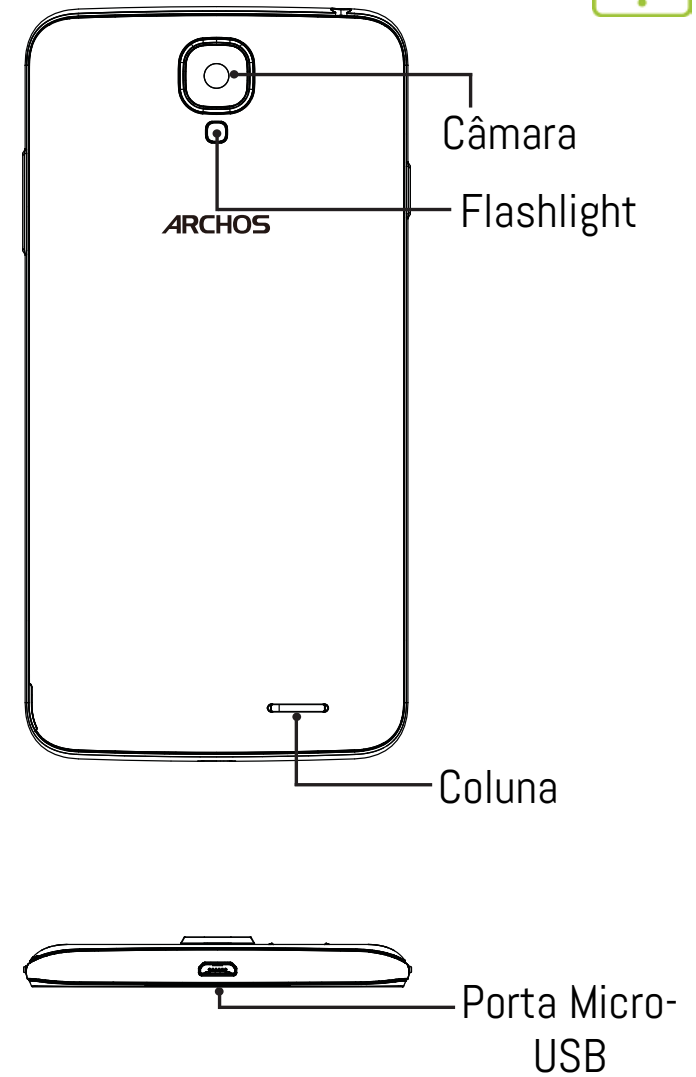
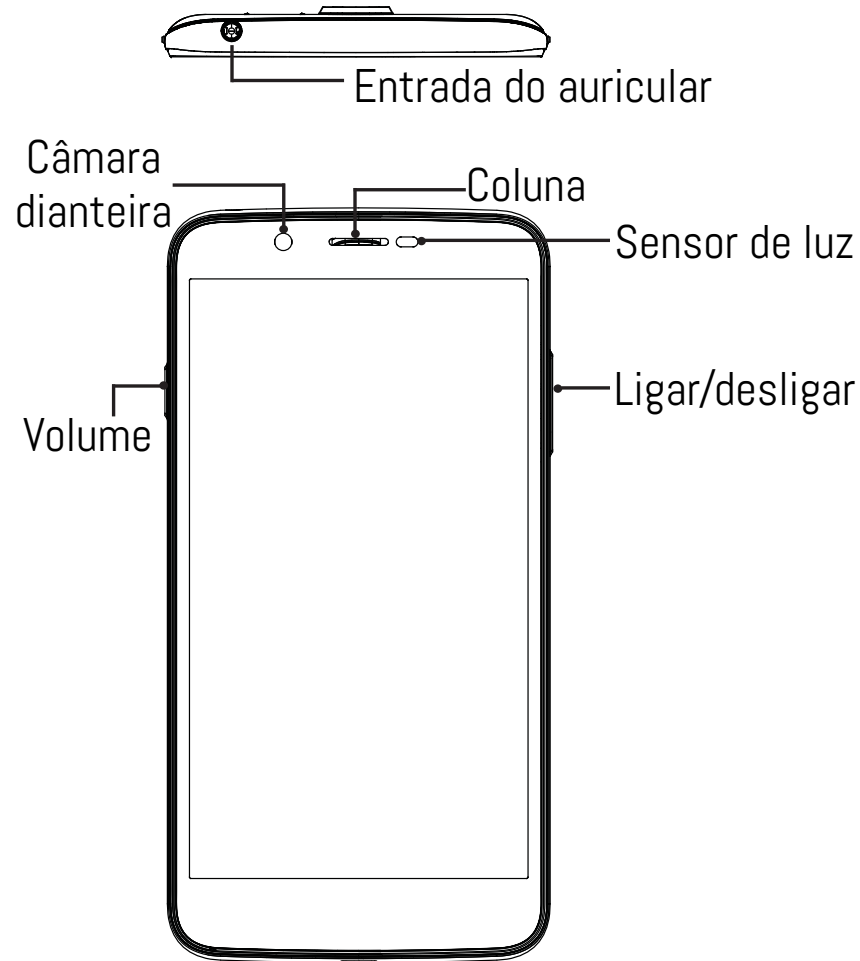



Montagem

Após desembalar a caixa do seu telemóvel:

1. remova a capa posterior do dispositivo através do entalhe.
2. Introduza o seu cartão SIM na ranhura correspondente.
3. Introduza a bateria do dispositivo.
4. Volte a colocar a capa posterior.

4G	1	Micro-SIM
3G/2G	2	Mini SIM
Micro-SD-kaart	3	

Quando inserir um cartão SIM ou um cartão micro-SD, certifique-se de que segue a ilustração, senão poderá danificar a ranhura ou o cartão.

A RANHURA MINI SIM ESTÁ ABAIXO DA RANHURA MICRO-SIM.

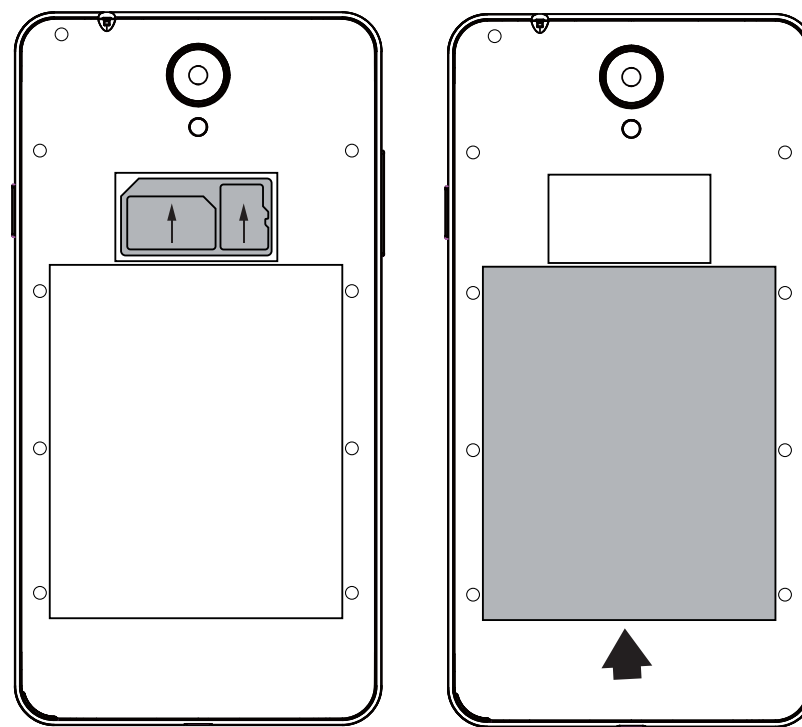
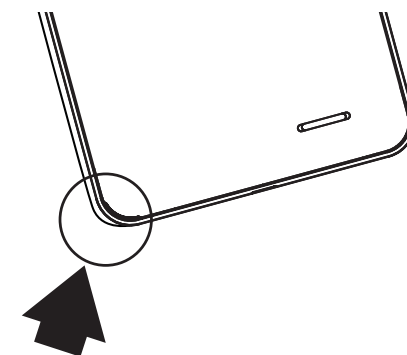



Carregar a bateria

Ligue o cabo de carregamento à entrada Micro USB e ao seu carregador.
Antes de utilizar o seu dispositivo pela primeira vez, carregue totalmente a bateria.



Ligar

1. Prima e mantenha premido o botão LIGAR/DESLIGAR para ligar o dispositivo.
2. Siga as instruções.

Ligação de dados móveis (3G)

1. Toque e puxe para baixo a barra de estado para exibí-la.
2. Toque de novo na barra para revelar as definições rápidas.
3. Selecione o ícone "Settings" (Definições).
4. Em Sem fios e redes, selecione Utilização de dados seguido do separador do Cartão SIM.
5. Deslize o botão de dados móveis para ligar/desligar.

Ligação Wi-Fi

1. Toque e puxe para baixo a barra de estado para exibí-la.
2. Toque de novo na barra para revelar as definições rápidas.
3. Selecione o ícone de Wi-Fi  para ativar a ligação Wi-Fi .
4. Selecione "Wi-Fi" abaixo do respetivo ícone.
5. Toque no nome da rede à qual pretende ligar-se.

As redes privadas são exibidas com um símbolo de cadeado e precisará de introduzir a sua palavra-passe.





Resolução de problemas

- O meu telefone bloqueou: prima o botão LIGAR/DESLIGAR por mais de 10 segundos ou remova a bateria e colocá-lo de novo no lugar.
- Meu dispositivo encontra disfunções: vá para Configurações> Sobre o telefone> Verificar sistema de atualização para verificar se há atualizações. Se o dispositivo é up-to-date, tente reiniciar o dispositivo de Configurações> Restaurar dados de fábrica> Backup e restauração. Recomendamos guardar os ficheiros antes de redefinir.
- Se as suas capacidades para Wi-fi forem reduzidas: certifique-se de que não está longe de um hotspot Wi-fi. Atualize o firmware do dispositivo: <http://www.archos.com/support>. Reponha e redefina os parâmetros de ligação. Contacte o seu prestador de serviços Wi-fi.
- Meu bootlogo dispositivo está jogando em um loop: você precisa redefinir completamente o seu dispositivo. Ir para faq.archos.com e selecione seu dispositivo. Em Backup & Recovery, selecione Como reinicializar meus ARCHOS.

PARA MAIS RESPOSTAS SOBRE DIFICULDADES TÉCNICAS, NÃO HESITE EM VISITAR: FAQ.ARCHOS.COM



Поздравляем с приобретением устройства ARCHOS! Данное краткое руководство по применению поможет с первых минут правильно пользоваться устройством. Если у вас возникнут другие вопросы относительно применения этого устройства, посетите веб-сайты:



twitter.com/archos



www.facebook.com/archos

Blog

<https://blog.archos.com/>



<http://faq.archos.com/>



на странице www.archos.com выберите меню Поддержка > Послепродажная поддержка



на странице www.archos.com выберите меню Поддержка > Загрузки > Декларация соответствия

Поскольку мы часто обновляем и совершенствуем свои изделия, программное обеспечение на вашем устройстве может незначительно отличаться по внешнему виду или функциональности от представленного в данном кратком руководстве.



Распаковка

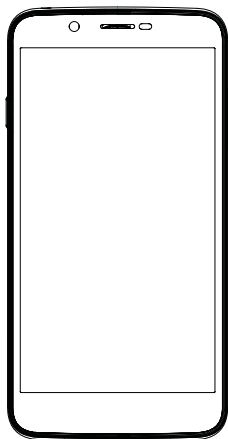

ARCHOS 55 Helium



Гарантии и инструкции по безопасности

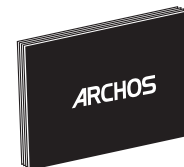

Краткое руководство



Адаптер зарядного устройства

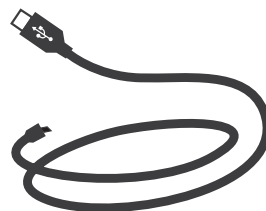

Кабель зарядного устройства

Описание устройства

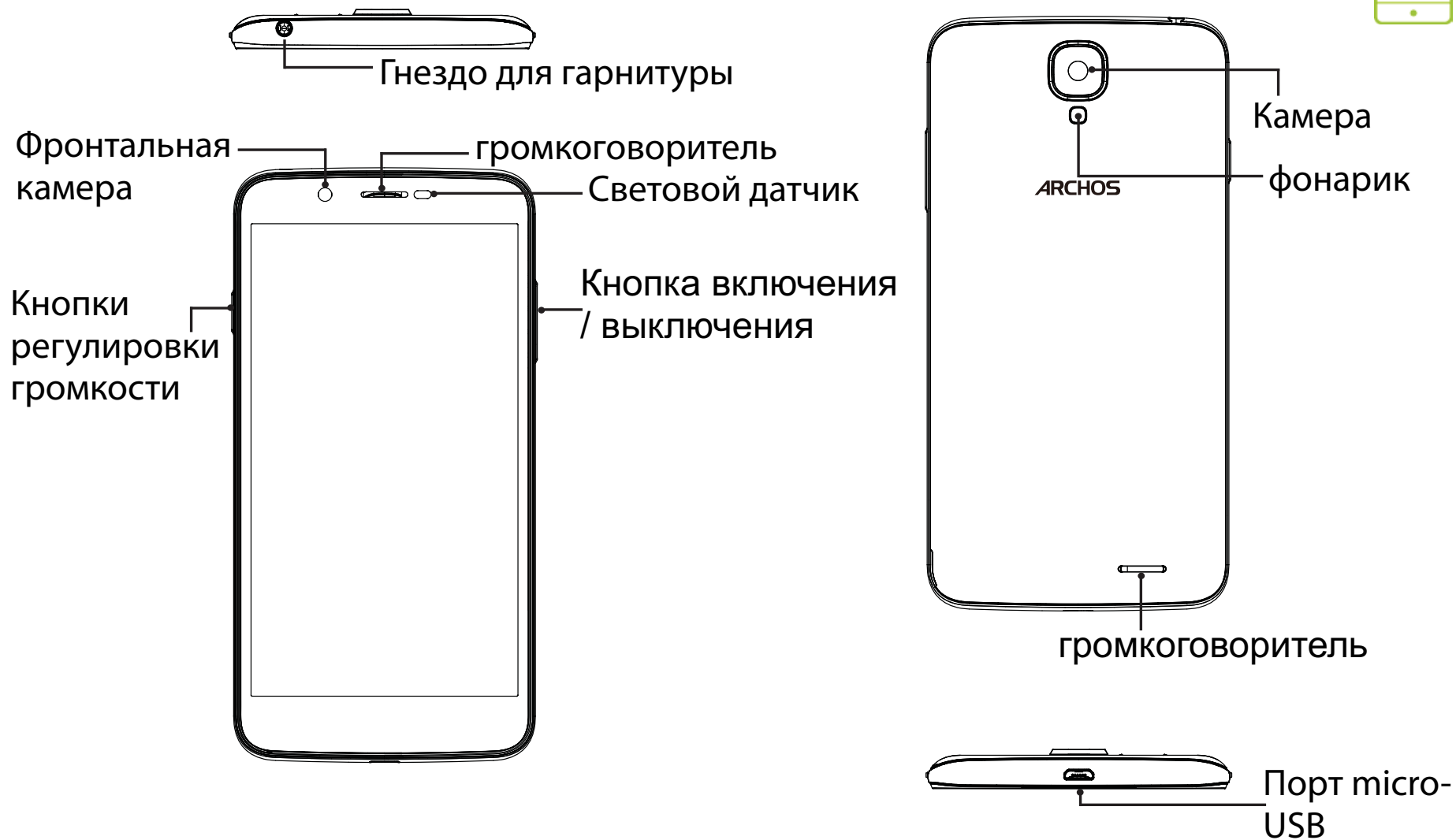



После извлечения мобильного телефона из коробки:

1. Снимите заднюю крышку устройства с помощью пазы.
2. Вставьте SIM-карту в соответствующее гнездо.
3. Вставьте аккумулятор в устройство.
4. Установите на место заднюю крышку.

4G	1	Micro-SIM
4G	2	Mini SIM
карты micro-SD	3	

При установке SIM-карты или карты micro-SD следует точно сверять свои действия с изображением, в противном случае можно повредить гнездо или карту.

СЛОТ MINI SIM НИЖЕ СЛОТ MICRO-SIM

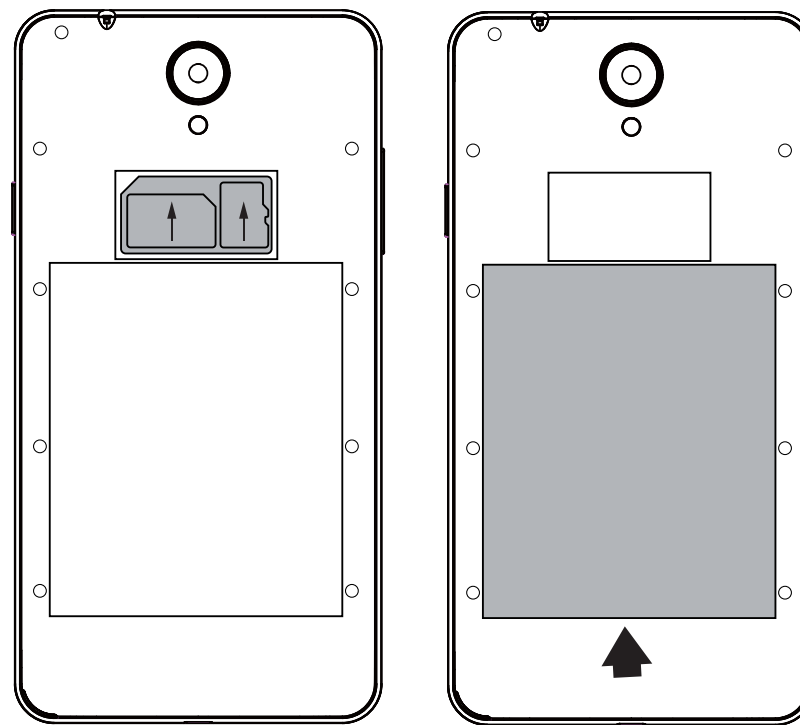
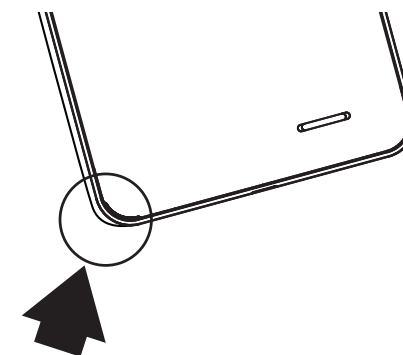

Начало работы



Зарядка

Вставьте зарядный кабель в порт Micro-USB, после чего присоедините кабель к зарядному устройству.

Перед первым использованием устройства полностью зарядите аккумулятор.

Включение

1. Нажмите и удерживайте кнопку ВКЛ./ВЫКЛ., чтобы включить устройство.
2. Следуйте инструкциям.



Подключение для мобильных данных

1. Коснитесь строки состояния и потяните ее вниз, чтобы отобразить строку.
2. Повторно коснитесь строки состояния, чтобы открыть быстрые настройки.
3. Выберите пиктограмму настроек.
4. Выберите Использование данных в разделе Беспроводные и проводные сети.

После этого выберите вкладку SIM-карты.

5. Перетяните переключатель Мобильные данные для включения или выключения данной опции.

Подключение WiFi

1. Коснитесь строки состояния и потяните ее вниз, чтобы отобразить строку.
2. Повторно коснитесь строки состояния, чтобы открыть быстрые настройки.
3. Выберите пиктограмму WiFi , чтобы активировать подключение WiFi .
4. Выберите WiFi под пиктограммой WiFi.
5. Коснитесь имени сети, к которой необходимо подключиться.

Частные сети отображаются с пиктограммой замка; для подключения к ним следует ввести пароль.





Поиск и устранение неисправностей

- Мое устройство заморожен: нажмите кнопку включения / выключения в течение более 10 секунд или удалите и замените батарею, а затем включите устройство.
- Мое устройство сталкивается с дисфункцией: перейдите в раздел Настройки > О телефоне > Проверить наличие обновлений системы, чтобы проверить наличие обновлений. Если устройство не работает до современных, попробуйте выполнить сброс устройства в меню Настройки > Сброс данных > Резервное копирование & восстановление. Мы рекомендуем, чтобы сохранить файлы перед сбросом.
- Если скорость работы Wi-Fi на прием слишком мала, убедитесь в том, что вы находитесь на должном расстоянии от точки доступа Wi-Fi. Обновите микропрограмму устройства: <http://www.archos.com/support>. Сбросьте и задайте заново параметры подключения. Свяжитесь с провайдером Wi-Fi-подключения.
- Мое устройство bootlogo играет в цикле: вам необходимо полностью перезагрузить коммуникатор. Перейти к faq.archos.com и выберите устройство. В Резервное копирование и восстановление выберите Как переинициализировать мои ARCHOS.

ДЛЯ ПОЛУЧЕНИЯ ОТВЕТОВ НА ДРУГИЕ ВОПРОСЫ, КАСАЮЩИЕСЯ ТРУДНОСТЕЙ ТЕХНИЧЕСКОГО ХАРАКТЕРА, ПОСЕТИТЕ ВЕБ-СТРАНИЦУ:
FAQ.ARCHOS.COM



Gratulujemy zakupu urządzenia ARCHOS! Skrócona instrukcja obsługi pomoże Ci we właściwym rozpoczęciu korzystania z urządzenia. Jeśli masz więcej pytań dotyczących użytkowania swojego urządzenia, odwiedź nas na:



twitter.com/archos



www.facebook.com/archos



<https://blog.archos.com/>



<http://faq.archos.com/>



www.archos.com, kliknij Support > After-sales support



www.archos.com, kliknij Support > Downloads > Declaration of conformity

Często aktualizujemy i wprowadzamy udoskonalenia w naszych produktach, dlatego też oprogramowanie może nieznacznie różnić się wyglądem lub dostępnością funkcji od tego, co zaprezentowano w skróconej instrukcji obsługi.



W pudełku

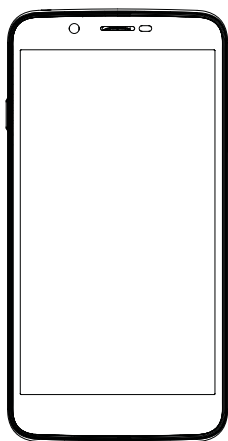

ARCHOS 55 Helium



Gwarancja, oświadczenia
prawne i informacje dotyczące
bezpieczeństwa



Skrócona instrukcja obsługi

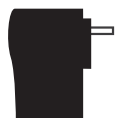

Ładowarka

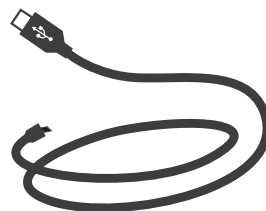

Kabel do ładowania

Opis urządzenia

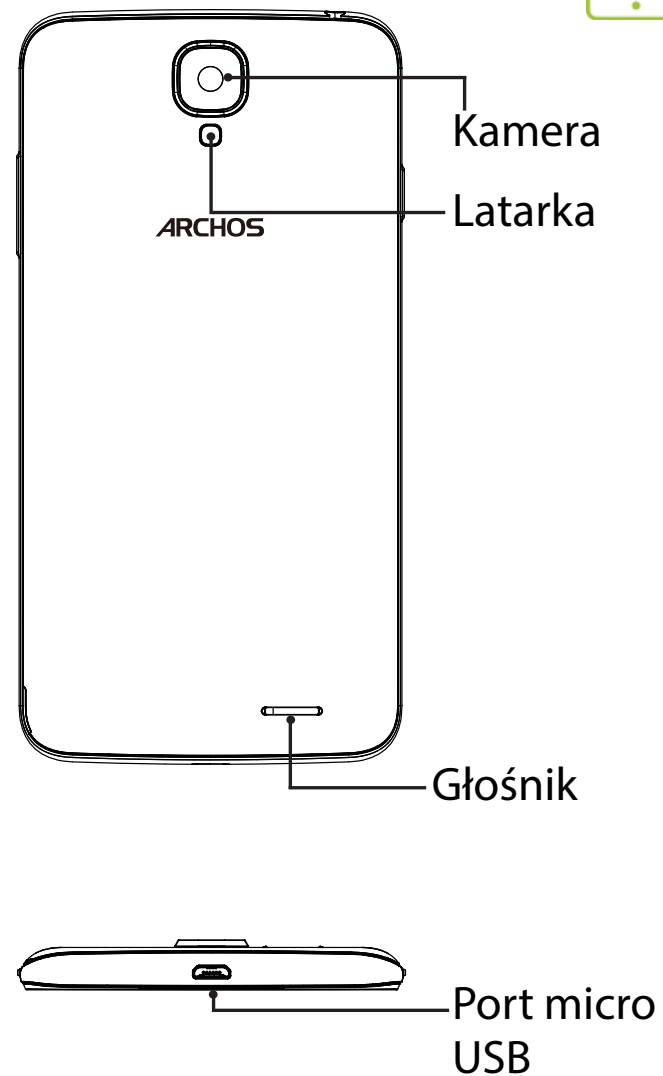



Montaż

Gdy rozpakujesz opakowanie z telefonem komórkowym:

1. Zdejmij klapkę tylną urządzenia, korzystając z przeznaczonego do tego rowka.
2. Włóż kartę SIM w odpowiednie gniazdo.
3. Włóż akumulator urządzenia.
4. Załóż klapkę tylną.

3G/2G	1	Micro-SIM
3G/2G	2	Mini SIM
kartę micro-SD	3	

Kartę SIM i kartę micro-SD należy wkładać dokładnie tak, jak jest pokazane na ilustracji, aby nie uszkodzić gniazda ani karty.

THE MINI SIM GNIAZDO ZNAJDUJE SIĘ PONIŻEJ GNIAZDA MICRO-SIM.

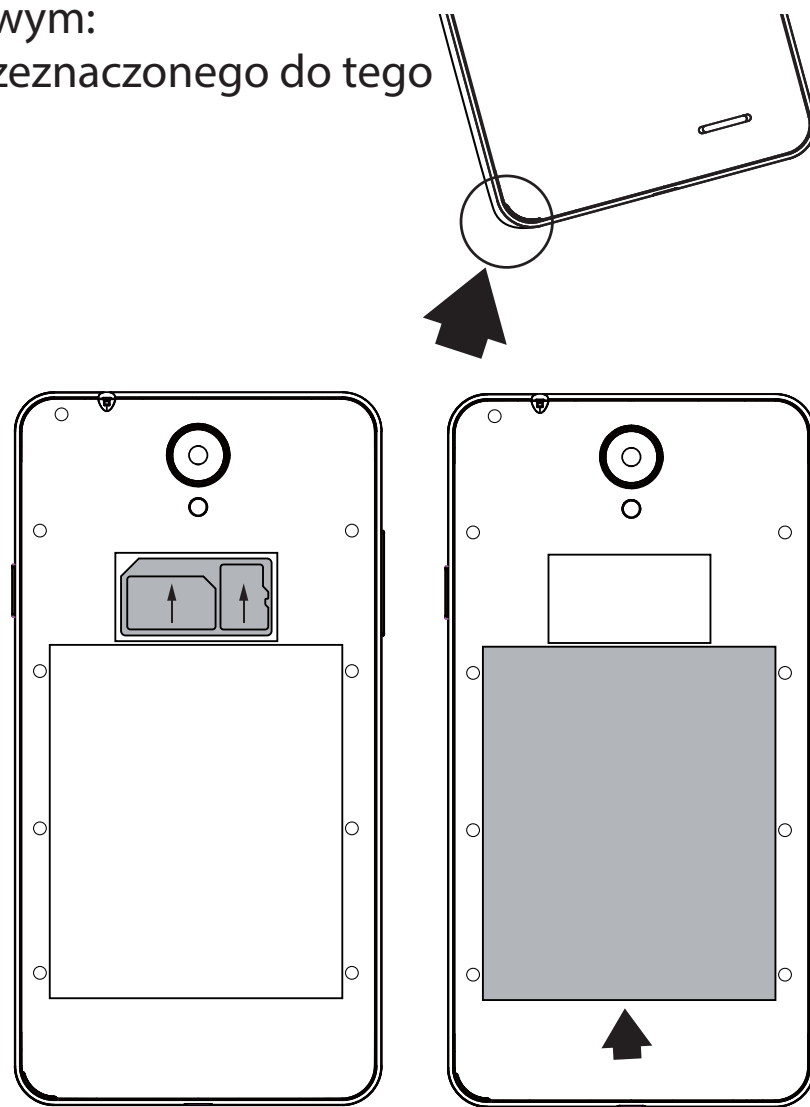

Uruchomienie



Ładowanie

Włóż wtyczkę kabla ładowania do portu Micro-USB i podłącz go do ładowarki. Przed pierwszym uruchomieniem urządzenia należy całkowicie naładować akumulator.



Włączanie urządzenia

1. Naciśnij i przytrzymaj przycisk zasilania, aby uruchomić urządzenie.
2. Postępuj według instrukcji.

Transmisja danych w sieci komórkowej (3G)

1. Dotknij pasek stanu i ściągnij go w dół, aby go wyświetlić.
2. Dotknij pasek ponownie, aby odsłonić szybkie ustawienia.
3. Wybierz ikonę Ustawienia.
4. W sekcji Wireless & networks wybierz opcję Data usage, a następnie kartę SIM card.
5. Dane mobilne można włączyć/wyłączyć, przesuwając przełącznik Mobile data.

Połączenie Wi-Fi

1. Dotknij pasek stanu i ściągnij go w dół, aby go wyświetlić.
2. Dotknij pasek ponownie, aby odsłonić szybkie ustawienia.
3. Wybierz ikonę Wi-Fi , aby uaktywnić połączenie Wi-Fi .
4. Wybierz „Wi-Fi” poniżej ikony Wi-Fi.
5. Dotknij nazwę sieci, z którą chcesz się połączyć.

Sieci prywatne wyświetlane są z ikoną kłódki – aby się z nimi połączyć, musisz wprowadzić hasło.





Rozwiązywanie problemów

- Moje urządzenie jest zamrożone: nacisnąć przycisk ON / OFF przez ponad 10 sekund lub wyjąć i wymienić baterię, a następnie włączyć urządzenie.
- Moje urządzenie napotyka dysfunkcje: przejdź do menu Ustawienia> Informacje o telefonie> Sprawdź uaktualnienia systemu, aby sprawdzić dostępność aktualizacji. Jeśli urządzenie jest up-to-date, spróbuj zresetować urządzenie z menu Ustawienia> Ustawienia fabryczne> Kopia zapasowa i przywracanie. Zaleca się, aby zapisać swoje pliki przed skasowaniem.
- Jeśli sygnał Wi-Fi jest zbyt słaby, upewnij się, że nie jesteś daleko od hotspotu Wi-Fi. Zaktualizuj oprogramowanie wbudowane: <http://www.archos.com/support>. Zresetuj i zmień parametry łączności. Skontaktuj się z dostawcą usług sieci Wi-Fi.
- Moje urządzenie bootlogo jest odtwarzany w pętli: trzeba całkowicie zresetować urządzenie. Idź do faq.archos.com i wybierz swoje urządzenie. W Backup & Recovery wybierz Jak ponownie zainicjować moje ARCHOS.

ABY UZYSKAĆ WIĘCEJ ODPOWIEDZI NA TEMAT PROBLEMÓW TECHNICZNYCH, ODWIEDŹ STRONĘ: FAQ.ARCHOS.COM



Gratulálunk új ARCHOS készüléke megvásárlásához! Ez a rövid felhasználói útmutató segítséget nyújt a készülék helyes használatának megkezdéséhez. Ha további kérdése van a készülékkel kapcsolatban, az alábbi elérhetőségeken kaphat választ:



twitter.com/archos



www.facebook.com/archos

Blog

<https://blog.archos.com/>



<http://faq.archos.com/>



www.archos.com, kattintson a Támogatás > Szerviz támogatás menüpontra



www.archos.com, kattintson a Támogatás > Letöltések > Megfelelőségi nyilatkozat menüpontra

Termékeink rendszeres frissítése és fejlesztése miatt előfordulhat, hogy az Ön készülékének szoftvere némiképp eltérően jelenik meg, vagy funkciói kismértékben eltérőek az ebben a Rövid felhasználói útmutatóban olvasottakhoz képest.



Kicsomagolás

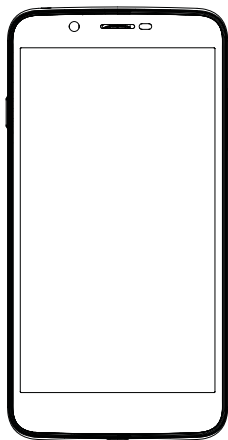

ARCHOS 55 Helium



Jótállási, jogi és biztonsági
információkat tartalmazó
füzet

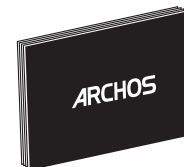

Rövid felhasználói útmutató



Töltőadapter

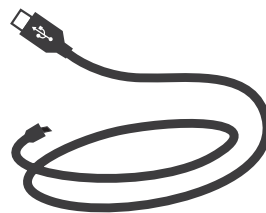

Töltőkábel

A készülék leírása

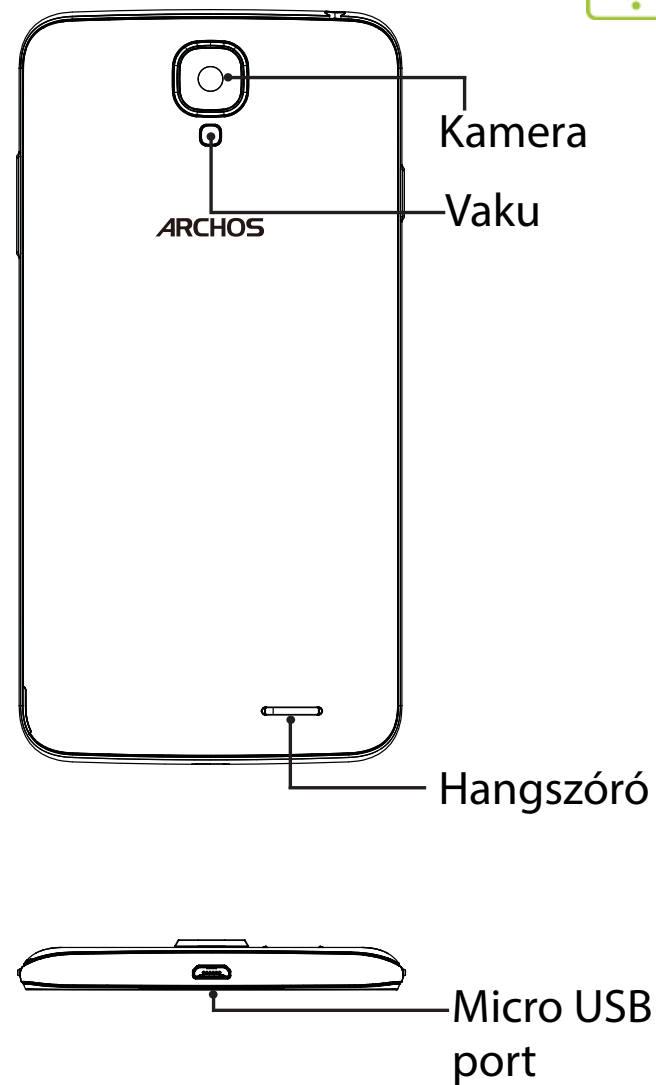



Összeszerelés

A mobiltelefon dobozának kicsomagolását követően:

1. A horonyba benyúlva távolítsa el a készülék hátlapját.
2. Helyezze be a SIM kártyát a megfelelő nyílásba.
3. Helyezze be a készülék akkumulátorát.
4. Helyezze vissza a hátlapot.

3G/2G	1	Micro-SIM
3G/2G	2	Mini SIM
micro SD-kártyát	3	

A SIM kártyát és a micro SD-kártyát feltétlenül az ábrán látható módon helyezze be, ellenkező esetben megsérülhet a nyílás vagy a kártya.
THE MINI SIM SLOT ALATT VAN A MIKRO-SIM FOGLALAT.

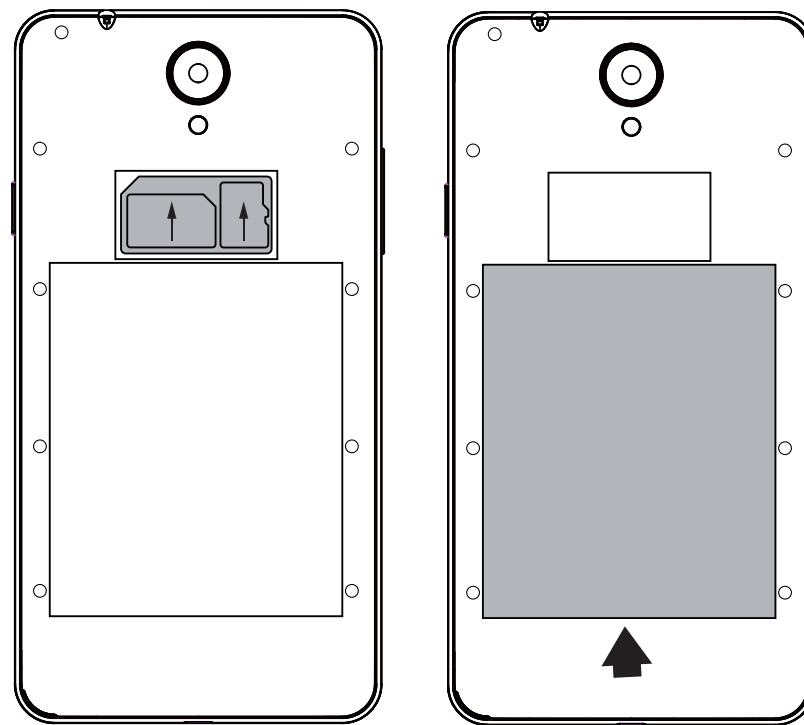
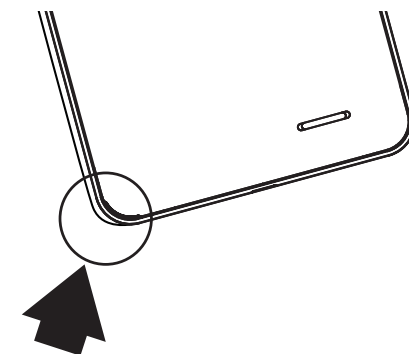



Töltés

Csatlakoztassa a töltőkábelt Micro USB-csatlakozóhoz és a töltőhöz. A készülék első használata előtt töltsse fel teljesen az akkumulátort.



Bekapcsolás

1. A készülék bekapcsolásához tartsa lenyomva a főkapcsolót.
2. Kövesse az utasításokat.

Mobil adatkapcsolat (3G)

1. A megjelenítéshez érintse meg és húzza lefelé az állapotjelző sávot.
2. A gyorsbeállítások felfedéséhez ismét érintse meg a sávot.
3. Válassza ki a Beállítások ikont.
4. A Vezeték nélküli és hálózatok részben válassza ki a Adathasználat, majd a SIM kártya lapot.
5. A ki- vagy bekapcsoláshoz csúsztassa el a Mobil adatok kapcsolót.

Wi-Fi kapcsolat

1. A megjelenítéshez érintse meg és húzza lefelé az állapotjelző sávot.
2. A gyorsbeállítások felfedéséhez ismét érintse meg a sávot.
3. Válassza ki a Wi-Fi ikont  a Wi-Fi kapcsolat  aktiválásához.
4. Válassza ki a „WiFi” elemet a Wi-Fi ikon alatt.
5. Érintse meg annak a hálózatnak a nevét, amelyikhez csatlakozni szeretne. A magánhálózatok mellett lakat szimbólum látható, és jelszó megadását kérik.





Hibaelhárítás

- Saját készülék lefagyott: nyomja meg az ON / OFF gombot több mint 10 másodpercig, vagy cserélje ki az akkumulátort, majd kapcsolja be a készüléket.
- Saját eszköz találkozik zavarok: menjen a Beállítások> A telefonról> Frissítések rendszer ellenőrzi a frissítéseket. Ha az eszköz up-to-date, próbálja visszaállítani a készüléket a Beállítások> Gyári adatok visszaállítása> Biztonsági mentés és visszaállítás. Javasoljuk, hogy mentse a fájlokat a visszaállítás előtt.
- Ha a Wi-Fi jelerősség túl gyenge: győződjön meg arról, hogy nincs túl messze a Wi-Fi hotspottól. Frissítse a készülék firmware-ét: <http://www.archos.com/support>. Állítsa vissza és állítsa be újra a csatlakozási paramétereket. Forduljon a Wi-Fi szolgáltatóhoz.
- Saját eszköz bootlogo játszik a hurok: meg kell, hogy teljesen a készülék újraindítására. Tovább a faq.archos.com és válassza ki az eszközt. Ezen biztonsági mentés és helyreállítás, válassza Hogyan újrainicializál az Archos.

MŰSZAKI PROBLÉMÁIRA AZ ALÁBBI CÍMEN IS TALÁLHAT VÁLASZT: FAQ.ARCHOS.COM

Open Source Software Offer

The software bundled with this product includes software files subject to certain open source license requirements. Such open source software files are subject solely to the terms of the relevant open source software license. Such open source software is provided on an "AS IS" basis to the maximum extent permitted by applicable law.

For the open source files contained herein, please access "Open source license" section located at: Settings>About phone\Legal information on the device for the relevant copyright and licensing terms. You may obtain a copy of Apache License, Version 2.0 at <http://www.apache.org/licenses/LICENSE-2.0>. You may also obtain a copy of GNU General Public License, Version 2 at the Free Software Foundation, INC, 51 Franklin Street, Fifth Floor, Boston, MA 02110-1301, USA.

Until the date that is three years after our last shipment of this product, you may obtain a copy of the source code corresponding to the binaries for any GPL-Licensed file by contacting ARCHOS customer service at <http://www.archos.com> and ARCHOS will send you a link to such source code or will provide instructions to get the source on a physical medium.

This offer is valid to anyone in receipt of this information.

National restrictions

This device is intended for home and office use in all EU countries (and other countries following the EU directive 1999/5/EC) without any limitation except for the countries mentioned below:

Country	Restriction	Reason/remark
Bulgaria	None	General authorization required for outdoor use and public service
France	Outdoor use limited to 10 mW e.i.r.p. within the band 2454-2483.5 MHz	Military Radiolocation use. Refarming of the 24 GHz band has been ongoing in recent years to allow current relaxed regulation. Full implementation planned 2012
Italy	None	If used outside of own premises, general authorization is required.
Luxembourg	None	General authorization required for network and service supply (not for spectrum)
Norway	Implemented	This subsection does not apply for the geographical area within a radius of 20 km from the centre of Ny-Alesund
Russian Federation	None	Only for indoor applications

Note: Frequencies 2454-2483.5MHz are restricted to indoor use in France.

SAR

After the laboratory measurements, the SAR values for this mobile are:

0.207 W/KG HEAD; 1489 W/KG BODY

Archos company (Contact adress : ARCHOS SA 12 Rue Ampère 91430 Igny France) declares that this device is in compliance with the essential requirements and other relevant provisions of Directive 1999/5/EC: http://www.archos.com/support/download/conformity/CE_DOC_AC55HE.pdf
Par la présente, ARCHOS (adresse de contact : ARCHOS SA 12 Rue Ampère 91430 Igny France) déclare que l'appareil est conforme aux exigences essentielles et aux autres dispositions pertinentes de la directive 1999/5/CE. La déclaration de conformité peut être consultée sur le site : http://www.archos.com/support/download/conformity/CE_DOC_AC55HE.pdf

C E 0700



032