



ENGLISH

USER GUIDE

LG Fortune™
LG-M153



About this user guide

Thank you for choosing this LG product. Please carefully read this user guide before using the device for the first time to ensure safe and proper use.

- Always use genuine LG accessories. The supplied items are designed only for this device and may not be compatible with other devices.
- This device is not suitable for people who have a visual impairment due to the touchscreen keyboard.
- Descriptions are based on the device default settings.
- Default apps on the device are subject to updates, and support for these apps may be withdrawn without prior notice. If you have any questions about an app provided with the device, please contact an LG Service Center. For user-installed apps, please contact the relevant service provider.
- Modifying the device's operating system or installing software from unofficial sources may damage the device and lead to data corruption or data loss. Such actions will violate your LG license agreement and void your warranty.
- Some content and illustrations may differ from your device, depending on the area, service provider, software version, or OS version, and are subject to change without prior notice.
- Software, audio, wallpaper, images, and other media supplied with your device are licensed for limited use. If you extract and use these materials for commercial or other purposes, you may be infringing copyright laws. As a user, you are fully responsible for the illegal use of media.
- Additional charges may incur for data services, such as messaging, uploading, downloading, auto-syncing and location services. To void additional charges, select a data plan suitable to your needs. Contact your service provider to obtain additional details.

Instructional notices



WARNING: Situations that could cause injury to the user and third parties.



CAUTION: Situations that may cause minor injury or damage to the device.



NOTE: Notices or additional information.

Table of contents

01

Custom-designed Features

- 6 quick share
- 7 QuickMemo+
- 9 KnockON
- 9 Knock Code
- 10 Do not disturb

02

Basic Functions

- 12 Product components and accessories
- 13 Parts overview
- 15 Turning the power on or off
- 16 Installing the SIM card
- 17 Inserting the memory card
- 19 Removing the memory card
- 19 Battery (removable)
- 23 Touch screen
- 27 Home screen
- 35 Screen lock
- 37 Memory card encryption
- 39 Entering text

03

Useful Apps

- 47 Installing and uninstalling apps
- 48 Uninstalled apps
- 49 Phone
- 53 Messaging
- 54 Camera
- 60 Gallery
- 62 Email
- 64 Calendar
- 66 Calculator
- 66 Downloads
- 67 File Manager
- 67 FM Radio
- 67 Voice Recorder
- 68 Contacts
- 69 Tasks
- 70 LG Backup
- 71 Google apps

04

Phone Settings

- 74 Settings
- 74 Networks
- 82 Sound & notification
- 83 Display
- 84 General

05

Appendix

- 92 Phone software update
- 94 FAQ
- 97 Anti-Theft Guide
- 98 More information

06

For Your Safety

07

LIMITED WARRANTY STATEMENT





01

Custom-designed Features

quick share

You can share a photo or video to the app you want immediately after taking them.

- 1 Tap  , then take a photo or record a video.
- 2 Tap the app icon that appears on the screen to share it using that app.

You can also swipe the icon towards the opposite direction to see what other apps you can use to share your photos and videos.

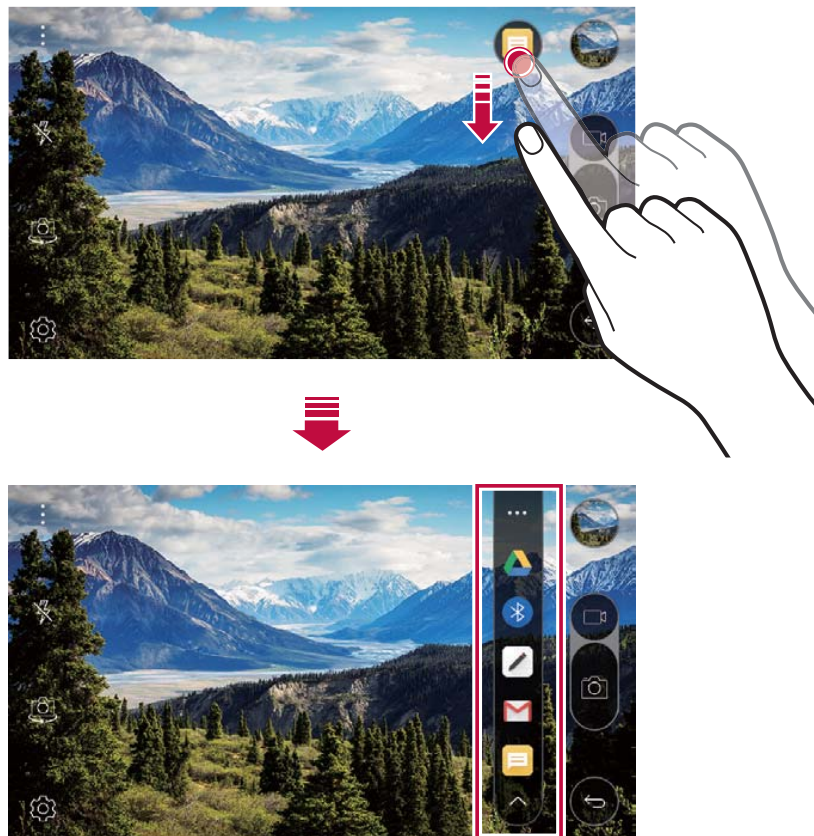











- The app displayed by the quick share icon may vary, depending on the type and frequency of access of the apps installed on the device.

QuickMemo+



QuickMemo+ overview

You can make creative notes by using a variety of options on this advanced feature of notepad, such as image management and screenshots, which are not supported by the conventional notepad.

Creating a note

- 1 Tap  > **Tools** > **QuickMemo+**.
- 2 Tap  to create a note.
 - : Undo the last action.
 - : Redo the last action you undid.
 - : Enter a note by using the keypad.
 - : Write notes by hand.
 - : Erase handwritten notes.
 - : Zoom in or out, rotate or erase the parts of a handwritten note.
 - : Access additional options.
- 3 Tap  > **Done** to save the note.

Writing notes on a photo



- 1 Tap  > **Tools** > **QuickMemo+**.
- 2 Tap  to take a photo, then tap **OK**.
 - The photo is automatically attached into the notepad.
- 3 Freely write notes on the photo.
- 4 Tap  > **Done** to save the note.

Writing notes on a screenshot

- 1 While viewing the screen you want to capture, drag the status bar downwards and then tap **Capture+**.
 - The screenshot appears as the notepad background theme. Memo tools appear at the top of the screen.
- 2 Take notes on the captured screen.
 - Write notes by hand on the photo.
 - To crop and save a portion of the screen, tap  and specify a portion with the crop tool.
 - To attach a screenshot to the notepad, tap **T**.
- 3 Tap **:** > **Done** and save the notes to the location you want.
 - Saved notes can be viewed in either **QuickMemo+** or **Gallery**.
 - To save notes in the same location all the time, select the **Use as default app** checkbox and select an app.

Managing folders

You can view notes grouped by the type of the notes.

- 1 Tap **○** > **Tools** > **QuickMemo+**.
- 2 At the top of the screen, tap **≡** and select a menu item:
 - **All memos**: View all notes saved in QuickMemo+.
 - **My memos**: View notes created by QuickMemo+.
 - **Photo memos**: View notes created by .
 - **Capture+**: View notes created by Capture+.
 - **Trash**: View deleted notes.
 - **New category**: Add categories.
 - : Rearrange, add or delete categories. To change the name of a category, tap the category.



- Some folders do not appear when launching QuickMemo+ for the first time. Disabled folders are enabled and appear when they contain at least one related note.

KnockON

The KnockON feature allows you to double-tap the screen to easily turn it on or off.

Turning the screen on

- 1 Double-tap the middle of the screen to turn the screen on.
- 2 Unlock the screen or access any of the available shortcuts or widgets.

Turning the screen off

- 1 Double-tap an empty area of the screen or the Status Bar.
- 2 The screen will turn off.



- For better recognition performance, tap on the center of the screen, but not on the bottom or on the top of the screen.

Knock Code

The Knock Code feature allows you to create your own unlock code using a combination of knocks on the screen. You can access the Home screen directly when the screen is off by tapping the same sequence on the screen.



- If you enter the wrong Knock Code 6 times, you will be required to enter to backup PIN.
- Use your fingertip instead of your fingernail to tap the screen to turn it on or off.

Setting up the Knock Code feature

- 1 Tap **○ > Tools > Settings > Display > Lock screen > Select screen lock > Knock Code.**

- 2 Tap the squares in a pattern to set your Knock Code. Your Knock Code pattern can be 6 to 8 taps.

Unlocking the screen using the Knock Code

When the screen turns off, you can unlock the screen by tapping the Knock Code pattern you already set.

Do not disturb

You can limit or mute notifications to avoid disturbances for a specific period of time.

- 1 Tap  > **Tools** > **Settings** > **Sound & notification** > **Do not disturb** and then drag to activate it.
- 2 Tap **Sounds and vibrations** and select the mode you want:
 - **Priority only:** Receive sound or vibrate notifications for the selected apps. Even when Priority only is turned on, alarms still sound.
 - **Total silence:** Disable both the sound and vibration.



Basic Functions

Product components and accessories

The following items are included with your device.

- Device
- Battery
- USB cable
- Charger
- Quick Start Guide



- The items supplied with the device and any available accessories may vary depending on the area and service provider.
- Always use genuine LG Electronics accessories. Using accessories made by other manufacturers may affect your device's call performance or cause malfunctions. This may not be covered by LG's repair service.



- If any of these basic items are missing, contact the dealer from which you purchased your device.
- To purchase additional basic items, contact an LG Customer Service Center.
- To purchase optional items, contact an LG Customer Service Center for available dealers.
- Some items in the product box are subject to change without notice.
- The appearance and specifications of your device are subject to change without notice.
- Device specifications may vary depending on the area or service provider.
- Be sure to use authentic accessories provided by LG Electronics. Using third-party accessories may damage the device or cause malfunctions.
- Remove the protective film on the camera lens if necessary.

Parts overview

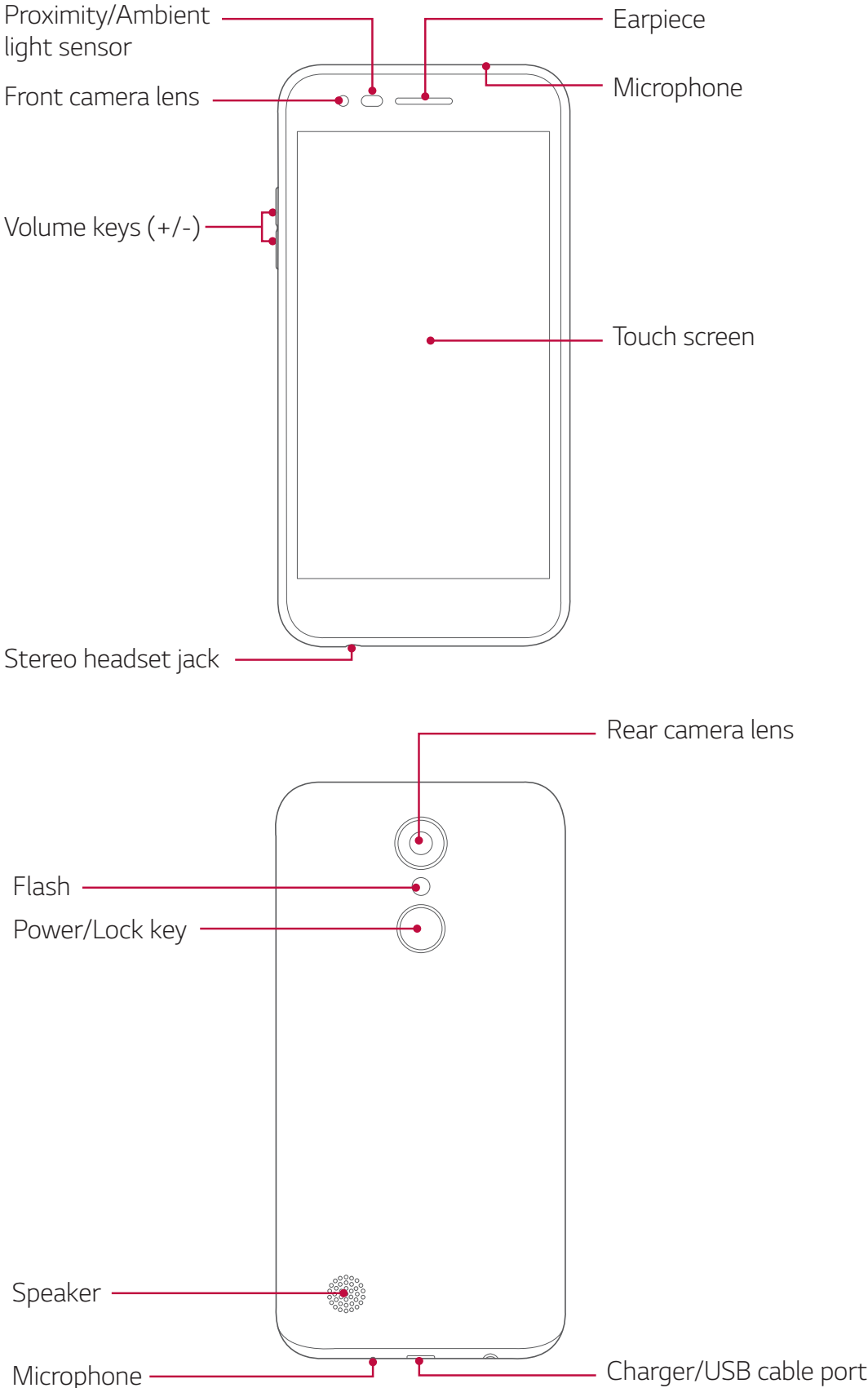

- Proximity/Ambient light sensor
 - Proximity sensor: During a call, the proximity sensor turns off the screen and disables touch functionality when the device is in close proximity to the human body. It turns the screen back on and enables touch functionality when the device is outside a specific range.
 - Ambient light sensor: The ambient light sensor analyzes the ambient light intensity when the auto-brightness control mode is turned on.
- Volume keys
 - Adjust the volume for ringtones, calls or notifications.
 - While using the Camera, gently press a Volume key to take a photo. To take continuous shots of photos, press and hold the Volume key.
 - Press the Volume Down (-) key twice to launch the **Camera** app when the screen is locked or turned off. Press the Volume Up (+) key twice to launch **Capture+**.
- Power/Lock key
 - Briefly press the key when you want to turn the screen on or off.
 - Press and hold the key when you want to select a power control option.



- Some functions may be restricted for access, depending on the device specifications.
- Do not put heavy objects on the device or sit on it. Doing so may damage the touch screen.
- Screen-protective film or accessories may interfere with the proximity sensor.
- If your device is wet or is being used in a humid place, the touch screen or buttons may not function properly.

Turning the power on or off

Turning the power on

When the power is turned off, press and hold the Power/Lock key, which is located in the back of the phone.



- When the device is turned on for the first time, initial configuration takes place. The first booting time for the smart phone may be longer than usual.

Turning the power off

Press and hold the Power/Lock key, then select **Power off**.

Power control options

Press and hold the Power/Lock key, then select an option.

- **Power off:** Turn off the device.
- **Restart:** Restart the device.
- **Turn on Airplane mode:** Block telecommunication-related functions, including making phone calls, messaging and browsing the Internet. Other functions remain available.

Installing the SIM card

Insert the SIM (Subscriber Identity Module) card provided by your service provider to start using your device.

- 1 To remove the back cover, hold the phone firmly in one hand. With your other hand, lift off the back cover with your thumbnail as shown in the figure below.

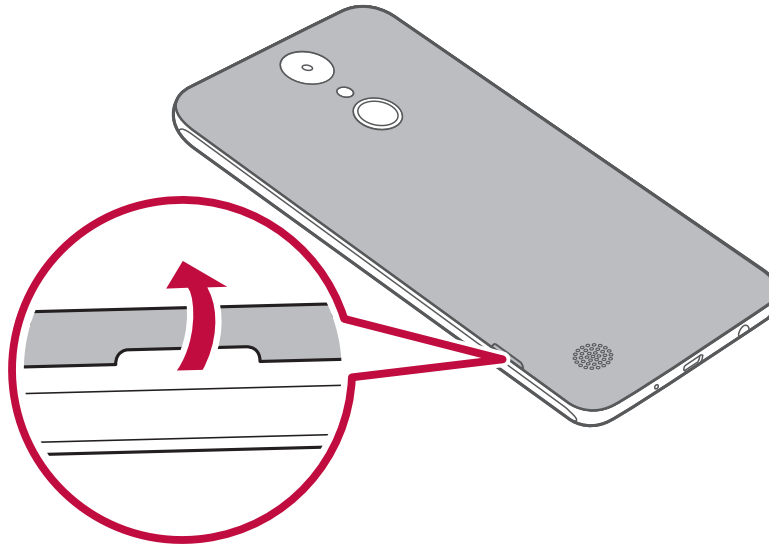

- 2 Slide the SIM card into the SIM card slot with the gold-colored contacts facing downwards.

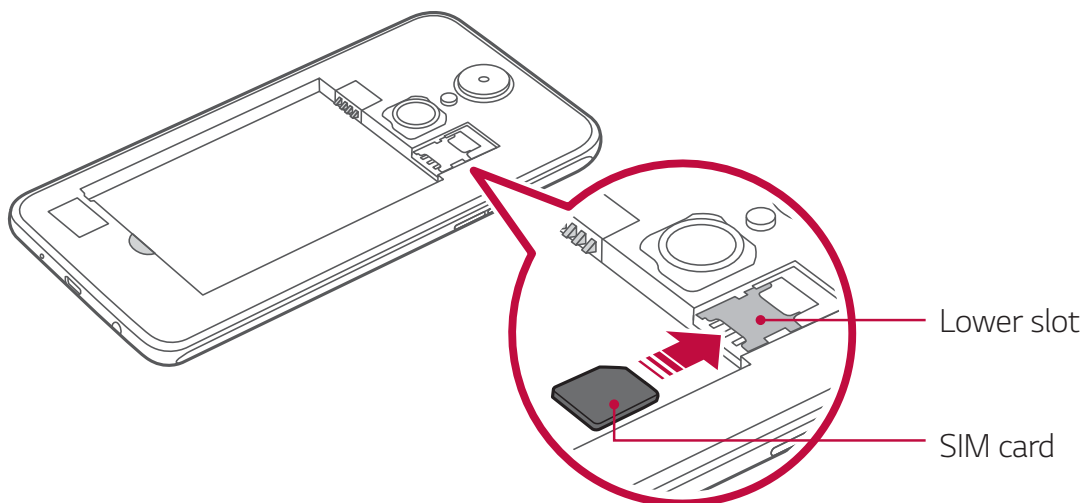



- This device supports only Nano SIM cards.

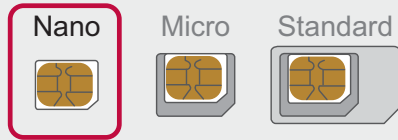

- For problem-free performance, it is recommended to use the phone with the correct type of SIM card. Always use a factory-made SIM card supplied by the service provider.

Precautions when using the SIM card

- Do not lose your SIM card. LG is not responsible for damage and other issues caused by loss or transfer of a SIM card.
- Be careful not to damage the SIM card when you insert or remove it.

Inserting the memory card

The device can support up to a 32 GB microSD card. Depending on the memory card manufacturer and type, some memory card may not be compatible with your device.

- 1 To remove the back cover, hold the phone firmly in one hand. With your other hand, lift off the back cover with your thumbnail as shown in the figure below.

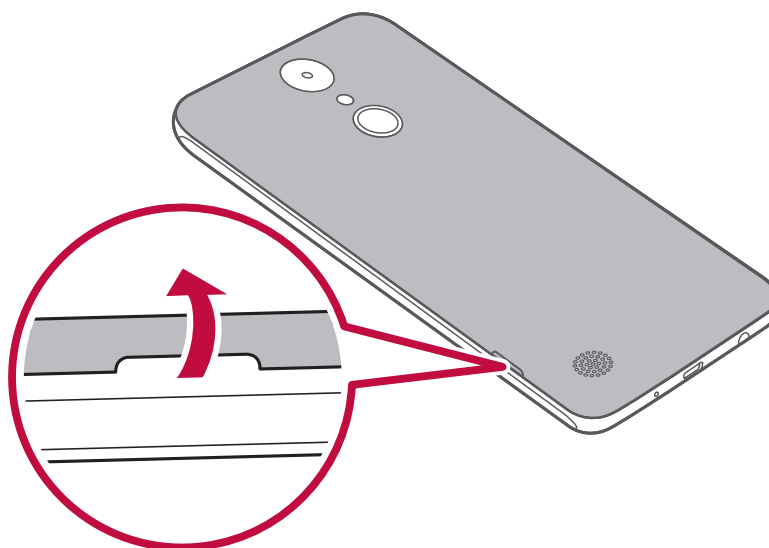

2 Insert the memory card into the memory card slot.

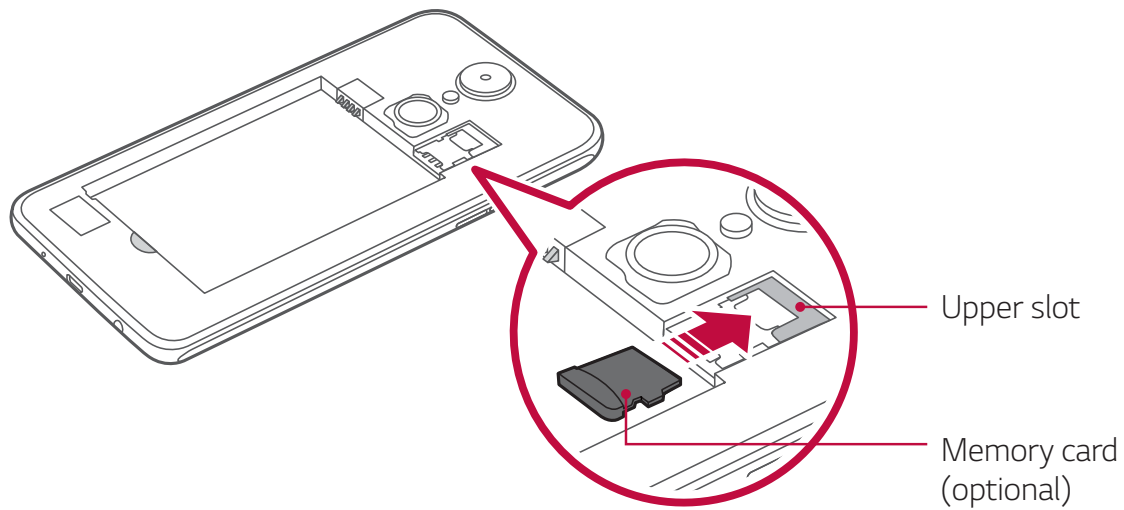



- Some memory cards may not be fully compatible with the device. If you use an incompatible card, it may damage the device or the memory card, or corrupt the data stored in it.



- Frequent writing and erasing of data may shorten the memory card lifespan.

Removing the memory card

Unmount the memory card before removing it for safety.

- 1 Tap  > **Tools** > **Settings** > **General** > **Storage & USB** > .
- 2 Remove the back cover and pull out the memory card.



- Do not remove the memory card while the device is transferring or accessing information. This may cause data to be lost or corrupted, or may damage the memory card or the device. LG is not responsible for losses that result from the abuse or improper use of memory cards, including the loss of data.

Battery (removable)

Installing the battery

- 1 To remove the back cover, hold the phone firmly in one hand. With your other hand, lift off the back cover with your thumbnail as shown in the figure below.

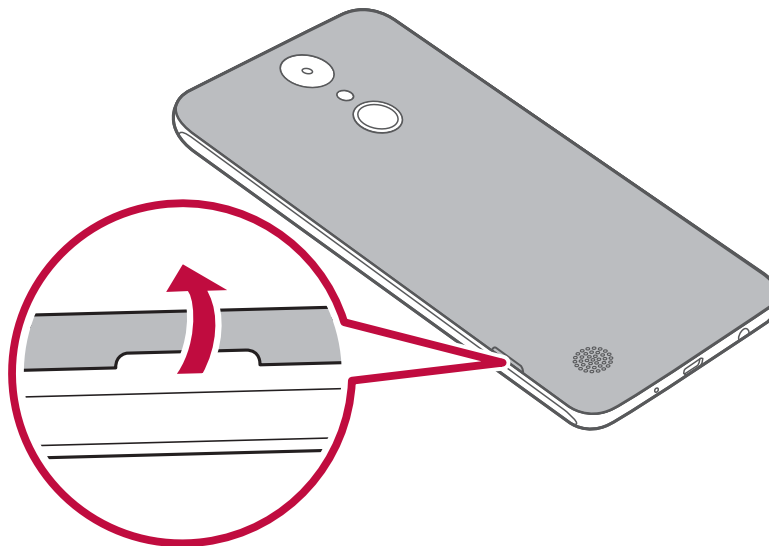

2 Insert the battery.

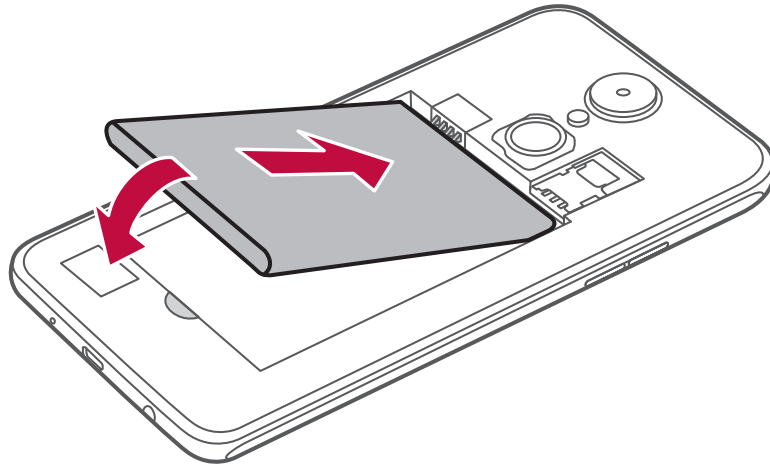

3 To replace the cover onto the device, align the back cover over the battery compartment and press it down until it clicks into place.

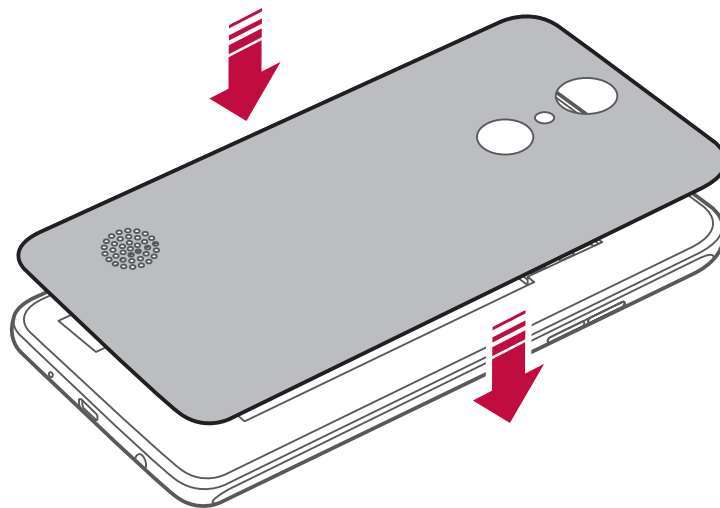

- Follow the instructions in this user guide cautiously when handling the device. Failure to do so may damage the device or cause injury to yourself or others.

Removing the battery

Open the back cover and pull out the battery.

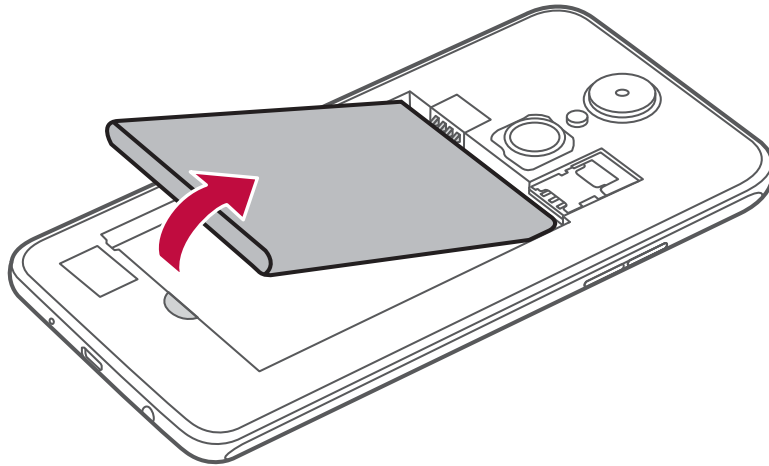

- Turn off the device before removing the battery. Failure to do so may damage the device.

Charging the battery

Before using the device, fully charge the battery.

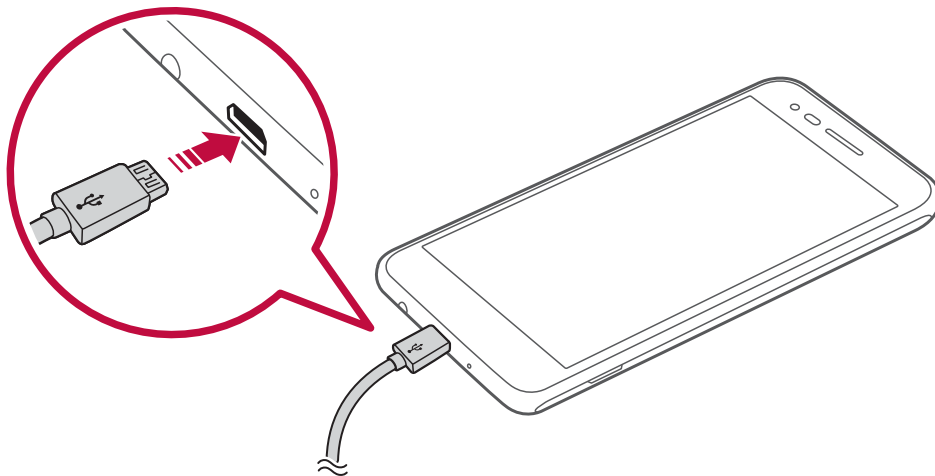



- Make sure to use the USB cable provided with your device.
- Make sure to use an LG-approved charger, battery and charging cable. Charging the battery with a third-party charger may cause the battery to explode or may damage the device.
- Using the device when it is charging may cause electric shock. To use the device, stop charging it.



- Remove the charger from the power socket after the device is fully charged. This prevents unnecessary power consumption.
- Another way to charge the battery is by connecting a USB cable between the device and a desktop or laptop computer. This may take a longer time than charging the battery in the common way.
- Do not charge the battery by using a USB hub that is unable to maintain the rated voltage. Charging may fail or unintentionally stop.

Precautions when using the device

- When replacing the battery, take extra care to ensure that no foreign substances or water enter the device.
- Ensure that the inside of the device does not make contact with a metallic object or water.
- Make sure to use the USB cable provided; do not use third party USB cables or chargers with your device. The LG limited warranty does not cover the use of third party accessories.
- Failure to follow the instructions in this guide and improper use may damage the device.

Using the battery efficiently

Battery lifespan may decrease if you keep many apps and functions running simultaneously and continuously.

Stop apps and functions from running in the background to increase battery life.

To minimize battery consumption, follow these tips:

- Turn off the Bluetooth® or Wi-Fi network function when not using them.
- Set the screen timeout to as short a time as possible.
- Minimize the screen brightness.
- Set a screen lock when the device is not used.
- Check the battery usage details and close any downloaded apps that are draining the battery.

Touch screen

You can familiarize yourself with how to control your device by using touch screen gestures.

Tapping

Lightly tap with your fingertip to select or run an app or option.

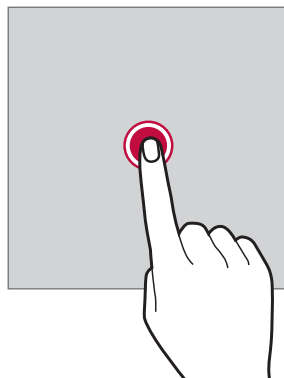

Touching and holding

Touch and hold for several seconds to display a menu with available options.

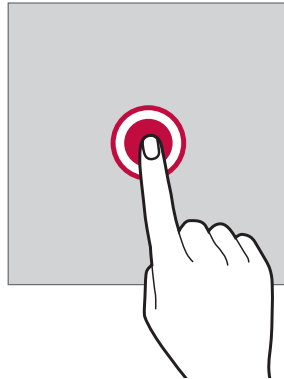

Double-tapping

Tap twice quickly to zoom in or out on a web page or map.

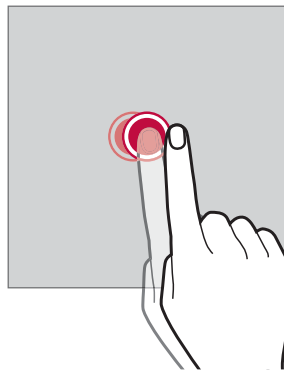

Dragging

Touch an item, such as an app or widget, then move your finger to another location in a controlled motion. You can use this gesture to move an item.

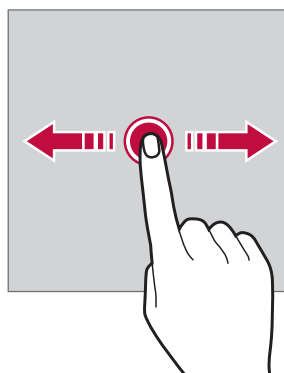

Swiping

Touch the screen with your finger and move it quickly without pausing. You can use this gesture to scroll through a list, a web page, photos, screens, and more.

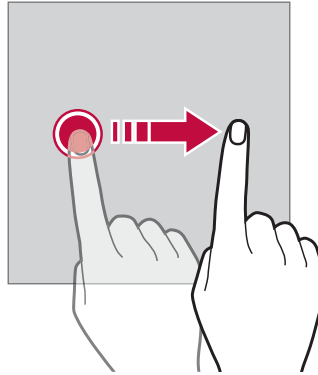

Pinching and spreading

Pinch two fingers to zoom out such as on a photo or map. To zoom in, spread your fingers apart.

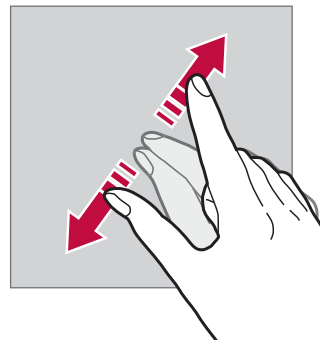
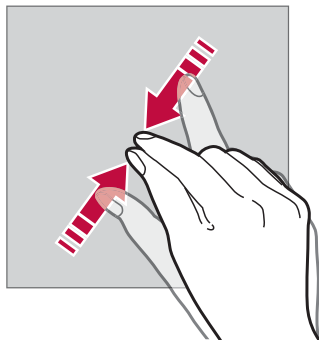

- Do not expose the touch screen to excessive physical shock. You might damage the touch sensor.



- A touch screen failure may occur if you use the device near a magnetic, metallic or conductive material.
- If you use the device under bright lights, such as direct sunlight, the screen may not be visible, depending on your position. Use the device in a shady location or a location with an ambient light that is not too bright and bright enough to read books.
- Do not press the screen with excessive force.
- Gently tap with your fingertip on the option you want.
- The touch control may not work properly if you tap while wearing a glove or by using the tip of your fingernail.
- Touch control may not work properly if the screen is moist or wet.
- The touch screen may not function properly if a screen-protective film or accessory purchased from a third party store is attached to the device.

Home screen

Home screen overview

The Home screen is the starting point for accessing various functions and apps on your device. Tap  on any screen to directly go to the Home screen.

You can manage all apps and widgets on the Home screen. Swipe the screen left or right to view all installed apps at a glance.

Home screen layout

You can view all apps and organize widgets and folders on the Home screen.

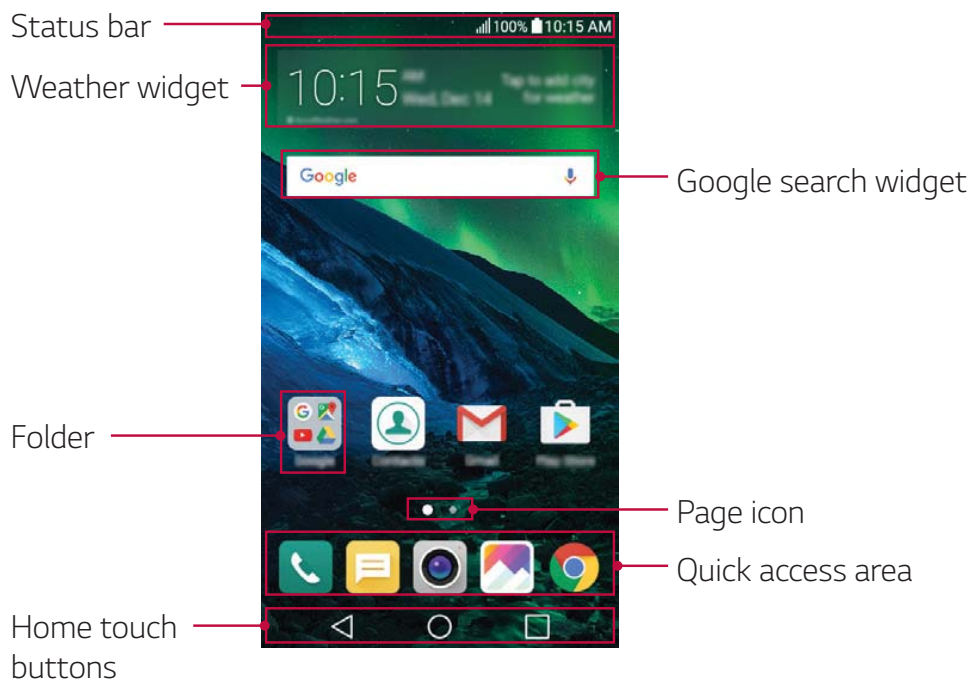

- The Home screen may vary, depending on the service provider or software version.

- **Status bar:** View status icons, the time and the battery level.
- **Weather widget:** View the weather information and time for a specific area.

- **Google search widget:** Perform a Google search by inputting spoken or written keywords.
- **Folder:** Create folders to group apps by your preferences.
- **Page icon:** Display the total number of Home screen canvases. Tap the desired page icon to go to the page you selected. The icon reflecting the current canvas will be highlighted.
- **Quick access area:** Fix main apps at the bottom of the screen so that they can be accessed from any Home screen canvas.
- **Home touch buttons**
 - ◀: Return to the previous screen. Close the keypad or pop-up windows.
 - ○: Tap to go to the Home screen. To launch Google search, touch and hold.
 - □: Tap to view a list of recently used apps or run an app from the list. To delete all the recently used apps, tap **Clear all**.

Editing the Home touch buttons

You can rearrange the Home touch buttons or add frequently used functions to the Home touch buttons area.





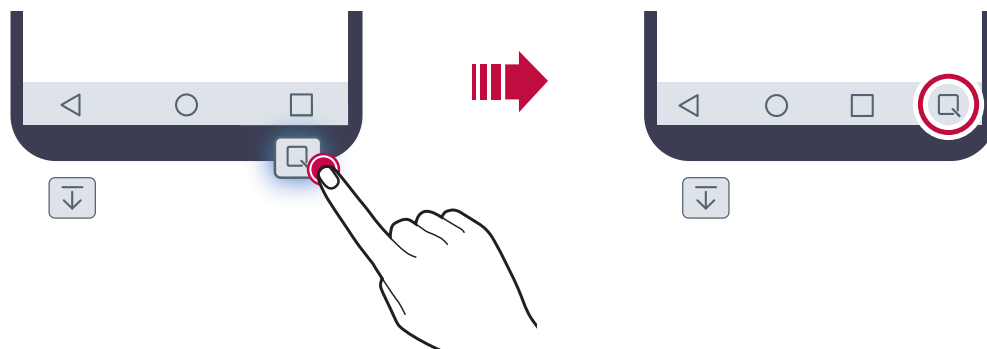









Tap ○ > **Tools** > **Settings** > **Display** > **Home touch button combination** and customize the settings.

- The Notification panel and Capture+ options are provided. A maximum of two items can be added.



Status icons

When there is a notification for an unread message, calendar event or alarm, the status bar displays the corresponding notification icon. Check your device's status by viewing notification icons displayed on the status bar.

	No signal
	Data is being transmitted over the network
	Alarm is set
	Vibrate mode is on
	Bluetooth is on
	Connected to a computer via USB
	Battery level
	Airplane mode is on
	Missed calls
	Wi-Fi is connected
	Mute mode is on
	GPS is on
	Hotspot is on
	No SIM card



- Some of these icons may appear differently or may not appear at all, depending on the device's status. Refer to the icons according to the actual environment in which you are using the device.
- Displayed icons may vary, depending on the area or service provider.

Notifications panel

You can open the notifications panel by dragging the status bar downwards.

Use quick access icons in the notifications panel to easily and quickly turn a function on or off.

Drag left or right on the list of quick access icons to select the function icon you want.

- If you tap and hold the icon, the settings screen for the corresponding function appears.

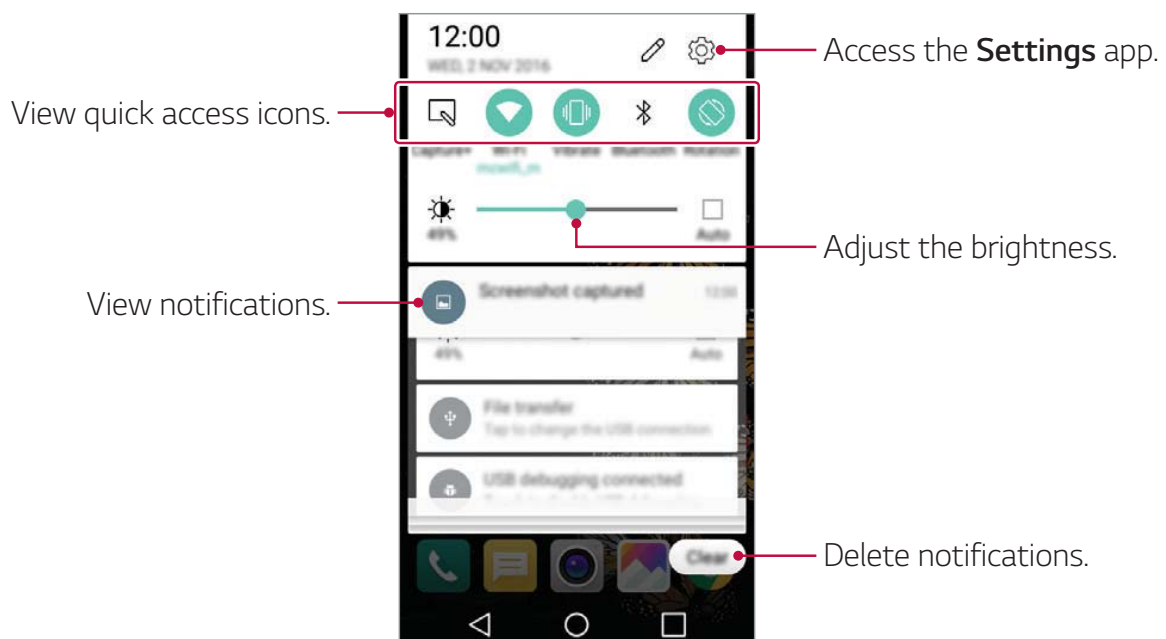

Notification panel settings

You can select items to display on the notification panel.

Tap  on the notification panel.

- To rearrange quick access icons, tap and hold an icon, then drag it to another position.
- Select icons you want to display on the list.

Switching the screen orientation

You can set the screen orientation to automatically switch, according to the device's physical orientation.

On the notification panel, tap **Rotation** from the quick access icon list.

You can also tap  > **Tools** > **Settings** > **Display** and activate **Auto-rotate screen**.

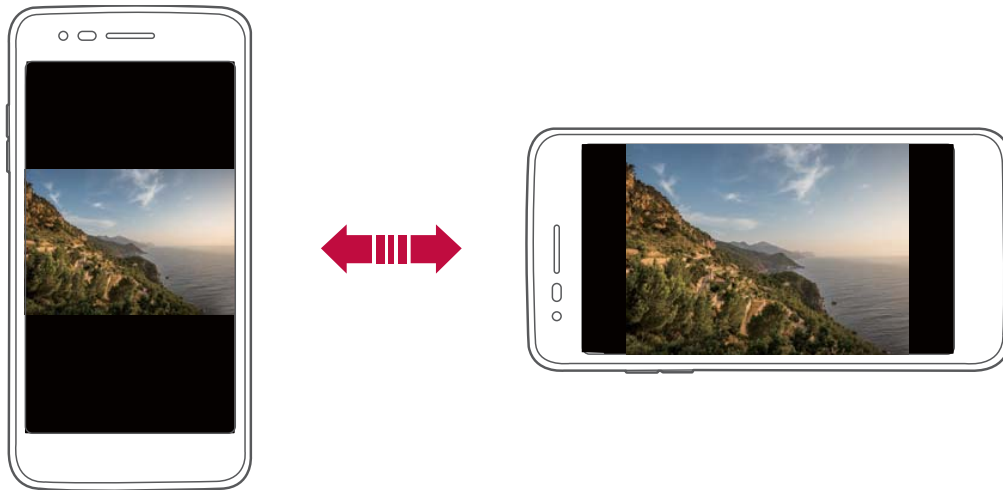

Editing the Home screen

On the Home screen, touch and hold on an empty space, then select the desired action from below.

- To rearrange the Home screen canvases, touch and hold on a canvas, then drag it to another location.
- To add a widget to the Home screen, touch and hold on a blank area of the Home screen, then select **Widgets**.
- To change a wallpaper, touch and hold on a blank area of the Home screen, then select **Wallpapers**.
- To configure the Home screen settings, touch and hold on a blank area of the Home screen, then select **Home screen settings**. See [Home screen settings](#) for details.
- To view or reinstall the uninstalled apps, touch and hold on a blank area of the Home screen, then select **Uninstalled apps**.

Viewing the background theme

You can view only the background image by hiding the apps and widgets on the Home screen.

Spread two fingers apart on the Home screen.

- To return to the original screen, which displays apps and widgets, pinch your fingers on the Home screen or tap ◀.

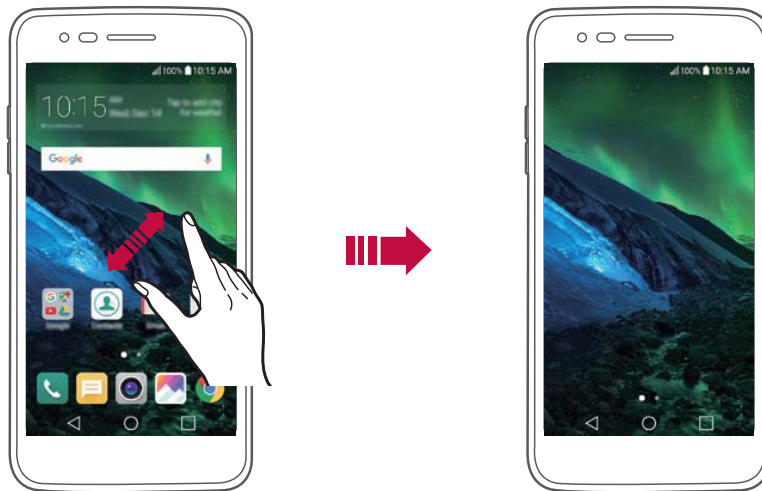

Moving apps on the Home screen

On the Home screen, touch and hold an app, then drag it to another location.

- To keep frequently used apps at the bottom of the Home screen, touch and hold an app, then drag it to the quick access area at the bottom.
- To remove an icon from the quick access area, drag the icon to the Home screen.

Using folders from the Home screen

Creating folders

On the Home screen, touch and hold an app, then drag it over another app.

- A new folder is created and the apps are added to the folder.

Editing folders

On the Home screen, tap a folder and do one of the following actions.

- To edit the folder name and color, tap the folder name.
- To add apps, touch and hold an app, then drag it over the folder and release it.
- To remove an app from the folder, touch and hold the app and drag it to outside the folder. If there is only one app remaining in the folder, the folder is removed automatically.
- You can also add or remove apps after tapping **+** in the folder.

Home screen settings

You can customize Home screen settings.

- 1 Tap **○ > Tools > Settings > Display > Home screen**.
- 2 Customize the following settings:
 - **Select Home:** Select a Home screen mode.
 - **Wallpaper:** Change the Home screen background wallpaper.
 - **Screen swipe effect:** Select an effect to apply when the Home screen canvas switches.
 - **Sort apps by:** Set how apps are sorted on the Home screen.
 - **Grid:** Change the app arrangement mode for the Home screen.
 - **Hide apps:** Select which apps you want to hide from the Home screen.

Select a home mode

You can select one of 3 modes.

- 1 Tap **Tools > Settings > Display > Home screen > Select Home**.
- 2 Choose the mode you want to use.
 - **Home (default)**: Provides the standard layout showing all apps.
 - **EasyHome**: Provides a simplified experience for the first-time smartphone user.
 - **Home & app drawer**: Provides a separate layout for the Home screen and apps list.

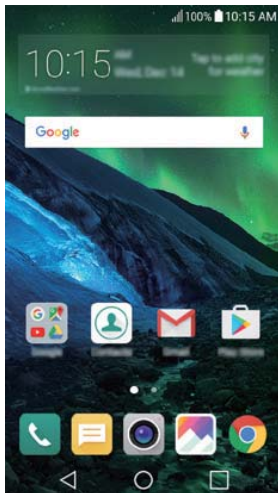

Home (default)



EasyHome

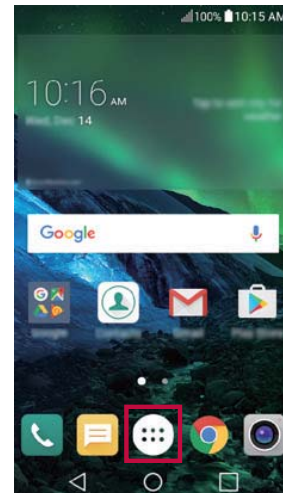

Home & app drawer

Screen lock

Screen lock overview

Your device's screen turns off and locks itself if you press the Power/Lock key. This also happens after the device is left idle for a specified period of time.

If you press the Power/Lock key when a screen lock is not set, the Home screen appears immediately.

To ensure security and prevent unwanted access to your device, set a screen lock.



- Screen lock prevents unnecessary touch input on the device screen and reduces battery consumption. We recommend that you activate the screen lock while not using the device.

Setting a screen lock

There are several options available for configuring the screen lock settings.

- 1 Tap **○ > Tools > Settings > Display > Lock screen > Select screen lock** and then select the method you prefer.
- 2 Choose from the following settings:
 - **None:** Deactivate the screen lock function.
 - **Swipe:** Swipe on the screen to unlock the screen.
 - **Knock Code:** Tap the spaces of the screen in accordance with a pattern to unlock the screen.
 - **Pattern:** Draw a pattern to unlock the screen.
 - **PIN:** Enter a numeric password to unlock the screen.
 - **Password:** Enter an alphanumeric password to unlock the screen.

Secure start-up settings

When you select Knock Code, Pattern, PIN or Password as a screen lock method, you can configure your device to be locked whenever turning on the device in order to secure your data.

- You cannot use all functions, except for emergency calls, until you unlock the device.
- If you forget your decryption password, you cannot restore encrypted data and personal information.

Lock screen settings

You can customize the following lock screen settings.

- 1 Tap  > **Tools** > **Settings** > **Display** > **Lock screen**.
- 2 Customize the following settings:
 - **Select screen lock:** Select a screen lock method.
 - **Smart Lock:** Select trusted items so that if you are connected to or near one, the device is automatically unlocked.
 - **Screen swipe effect:** Set screen transition effects when the screen is unlocked.
 - **Wallpaper:** Change the lock screen background wallpaper.
 - **Shortcuts:** Add an app shortcut and directly access the app from the lock screen by dragging the app shortcut.
 - **Contact info for lost phone:** Display emergency contact information on the lock screen.
 - **Lock timer:** Set the amount of idle time after which the device automatically locks.
 - **Power key instantly locks:** Instantly lock the screen when the Power/Lock key is pressed.



- Available setting items may vary, depending on the selected screen lock method.

Memory card encryption

You can encrypt and protect data saved on the memory card. The encrypted data in the memory card cannot be accessed from another device.

- 1 Tap  > **Tools** > **Settings** > **General** > **Security** > **Encrypt SD card**.
- 2 Read the on-screen overview of memory card encryption and then tap **CONTINUE** to continue.
- 3 Select an option and tap **ENCRYPT NOW**.
 - **New data encryption:** Encrypt only data that is saved on the memory card after encryption.
 - **Full encryption:** Encrypt all the data currently saved on the memory card.
 - **Exclude media files:** Encrypt all files, except for media files such as music, photos and videos.



- To encrypt the memory card, make sure that a screen lock is set using a PIN or password.
- Once memory card encryption starts, some functions are not available.
- If the device is turned off while encryption is underway, the encryption process will fail, and some data may be damaged. Therefore, be sure to check that the battery level is sufficient before starting encryption.
- Encrypted files are accessible only from the device where the files were encrypted.
- The encrypted memory card cannot be used on another LG device. To use the encrypted memory card on another mobile device, format the card.
- You can activate memory card encryption even when no memory card is installed into the device. Any memory card that is installed after encryption will automatically be encrypted.

Taking screenshots

You can take screenshots of the current screen you are viewing.

Via a shortcut

Press and hold the Power/Lock key and the Volume Down (-) key at the same time for at least two seconds.

- Screenshots can be viewed from the **Screenshots** folder in the **Gallery**.

Via Capture+

On the screen where you want to take a screenshot, drag the status bar downwards, then tap **Capture+**.



- When the screen is turned off or locked, you can access **Capture+** by pressing the Volume Up (+) key twice. To use this feature, tap **Tools > Settings > General** and turn on **Shortcut keys**.
- See *Writing notes on a screenshot* for details.

Entering text

Using the Smart keyboard

You can use the Smart keyboard to enter and edit text.

With the Smart keyboard, you can view text as you type without bothering to alternate between the screen and a conventional keyboard. This allows you to easily find and correct errors when typing.

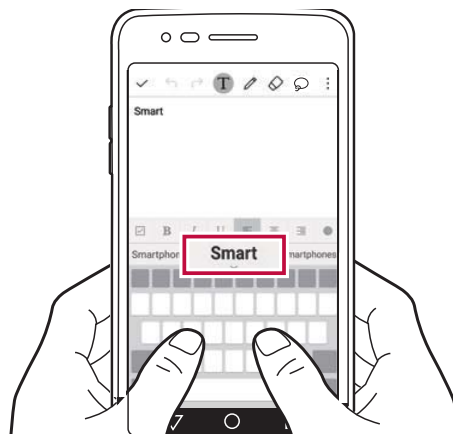

Moving the cursor

With the Smart keyboard, you can move the cursor to the exact position you want. When typing text, touch and hold on the space bar and then drag left or right.

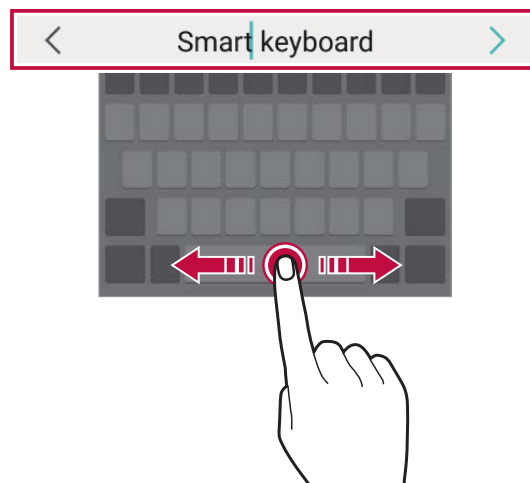

- This option is available only on the QWERTY keyboard.

Suggesting words

Smart keyboard automatically analyzes your usage patterns to suggest frequently used words as you type. The longer you use your device, the more precise the suggestions are.

Enter text, then tap a suggested word.

- The selected word is automatically entered. You do not need to manually type every letter of the word.

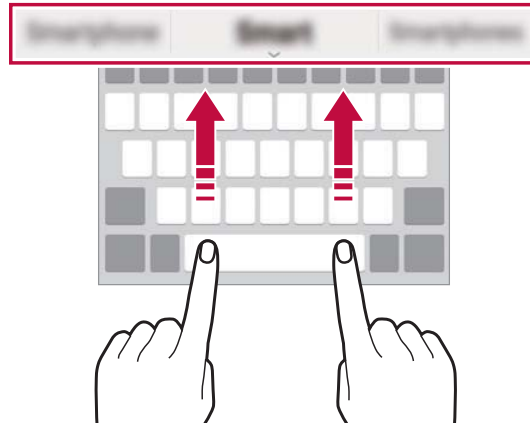

Changing the QWERTY keyboard layout

You can add, delete or rearrange keys on the bottom row of the keyboard.

- 1 Tap **○ > Tools > Settings > General > Language & keyboard > LG Keyboard > Keyboard height and layout > QWERTY keyboard layout.**

You can also tap  on the keyboard and tap **Keyboard height and layout > QWERTY keyboard layout.**

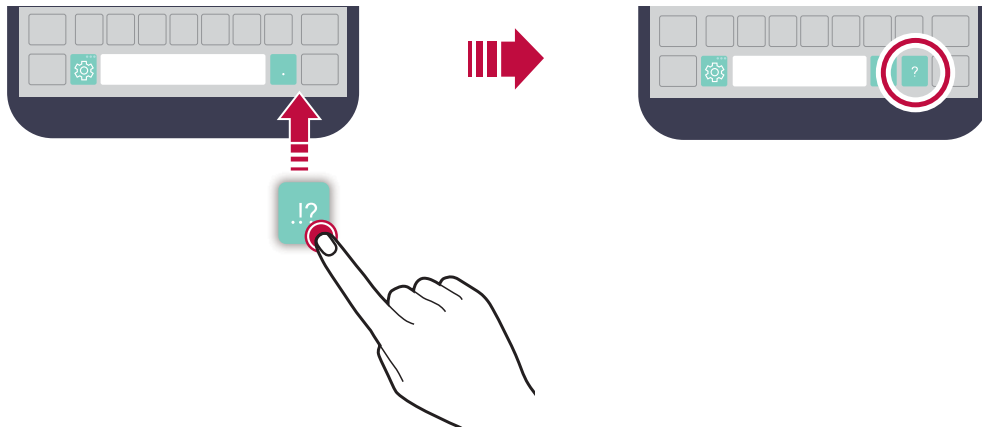

- 2 Touch and hold a key on the bottom row, then drag it to another position.



- This option is available on the QWERTY, QWERTZ and AZERTY keyboards.
- This function may not be supported for some languages.

Customizing the keyboard height

You can customize the keyboard height to maximize hand comfort when typing.

- 1 Tap  > **Tools > Settings > General > Language & keyboard > LG Keyboard > Keyboard height and layout > Keyboard height.**
You can also tap  on the keyboard and tap **Keyboard height and layout > Keyboard height.**
- 2 Adjust the keyboard height.

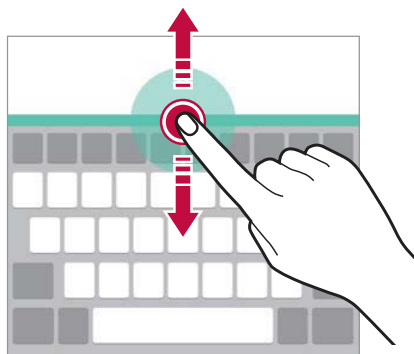

Selecting a landscape keyboard mode

You can select a landscape keyboard mode from several choices.

- 1 Tap **○ > Tools > Settings > General > Language & keyboard > LG Keyboard > Keyboard height and layout > Keyboard type in landscape.**

You can also tap  on the keyboard and tap **Keyboard height and layout > Keyboard type in landscape.**

- 2 Select a keyboard mode.

Splitting the keyboard

You can split the keyboard in half and place each piece on either side of the screen when the screen is in landscape mode.

Tap **○ > Tools > Settings > General > Language & keyboard > LG Keyboard > Keyboard height and layout > Split keyboard.**

You can also tap  on the keyboard and tap **Keyboard height and layout > Split keyboard.**



- Rotate the device to landscape mode to split the keyboard to both sides. To merge or split the keyboard, pinch together or spread apart your fingers on the keyboard.

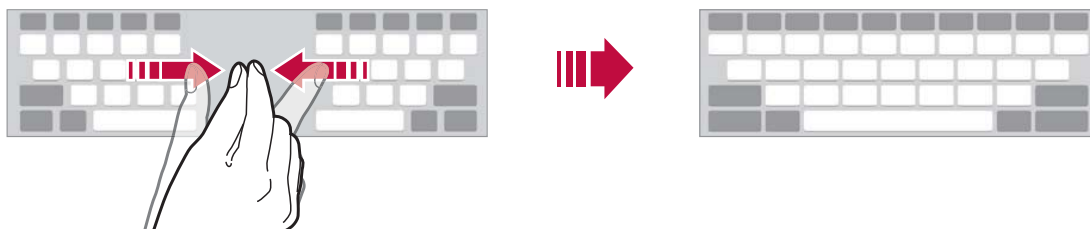

One-handed operation mode

You can move the keyboard to one side of the screen so that you can use the keyboard with one hand.

- 1 Tap **○ > Tools > Settings > General > Language & keyboard > LG Keyboard > Keyboard height and layout > One-handed operation.**

You can also tap  on the keyboard and tap **> Keyboard height and layout > One-handed operation.**

- 2 Press the arrow displayed next to the keyboard to move the keyboard in the direction you want.

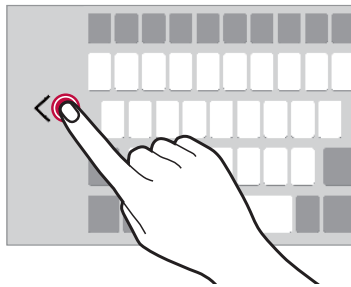

Entering text by using voice

On the keyboard, tap touch and hold  and then select .



- To maximize the voice command recognition, speak clearly.
- To enter text with your voice, make sure that your device is connected to a network.
- To select the language for voice recognition, tap  **> Languages** on the voice recognition screen.
- This function may be not supported, or the supported languages may differ depending on the service area.



Adding languages to the keyboard

You can make additional languages available for keyboard input.

- 1 Tap  > **Tools** > **Settings** > **General** > **Language & keyboard** > **LG Keyboard** > **Select languages**.
- 2 Select the languages you want to make available.

Copy and Paste

You can cut or copy text from an app, and then paste the text into the same app. Or you can run other apps and paste the text into them.





- 1 Touch and hold around the text you want to copy or cut.
- 2 Drag  /  to specify the area to copy or cut.
- 3 Select either **CUT** or **COPY**.
 - Cut or copied text is automatically added to the clipboard.
- 4 Touch and hold the text input window, then select **PASTE**.



- If there is no item that has been copied or cut, the **PASTE** option will not appear.

Clip Tray

If you copy or cut an image or text, it is automatically saved to the clip tray and can be pasted to any space at any time.

- 1 On the keyboard, touch and hold  and select .
You can also touch and hold the text input window, then select **CLIP TRAY**.
- 2 Select and paste an item from the clip tray.
 - A maximum of 10 items can be saved to the clip tray.
 - Tap  to lock saved items in order not to delete them, even when the maximum quantity is exceeded. A maximum of five items can be locked. To delete locked items, unlock them first.
 - Tap  to delete the items saved to the clip tray.



- The clip tray may not be supported by some downloaded apps.



Useful Apps

Installing and uninstalling apps

Installing apps

Access an app store to search and download apps.

- You can use the Play Store or the app store provided by your service provider.



- Some app stores may require you to create an account and sign in.
- Some apps may charge fees.
- If you use mobile data, you may be charged for data usage, depending on your pricing plan.
- SmartWorld may not be supported depending on the area or service provider.

Uninstalling apps

Uninstall apps that you no longer use from your device.

Uninstalling with the touch and hold gesture

On the Home screen, touch and hold the app to uninstall, then drag it over **Uninstall** at the top of the screen.

You can also touch and hold the app, then tap  to uninstall.

Uninstalling by using the settings menu

Tap  > **Tools** > **Settings** > **General** > **Apps**, select an app, then tap **Uninstall**.

Uninstalling apps from the app store

To uninstall an app, access the app store from which you download the app and uninstall it.



- Some apps cannot be uninstalled by users.

Uninstalled apps

You can view the uninstalled apps on the Home screen. You can also reinstall apps which were uninstalled within 24 hours from now.

- 1 Touch and hold on a blank area of the Home screen, then select **Uninstalled apps**.
- 2 Activate the desired function:
 - **Reinstall:** Reinstall the selected app.
 - : Remove the uninstalled apps permanently from the device.







- Uninstalled apps are automatically removed from the device 24 hours after they were uninstalled. If you want to reinstall the uninstalled apps, you must download them again from the app store.
- This feature is activated on the default Home screen only. If you uninstall apps while using the EasyHome screen or other launcher, they are immediately and permanently removed from the device.

Phone

Voice call

Make a phone call by using one of the available methods, such as manually entering a phone number and making a call from the contact list or the list of recent calls.



Making a call from the keypad

- 1 Tap  >  > **Dial**.
- 2 Make a call by using a method of your choice:
 - Enter a phone number and tap .
 - Touch and hold a speed dial number.
 - Search for a contact by tapping the initial letter of a contact name in the contact list, and then tap .



- To enter "+" when making an international call, touch and hold number 0.
- See [Adding contacts](#) for details on how to add phone numbers to the speed dial list.

Making a call from the contact list

- 1 Tap  >  > **Contacts**.
- 2 From the contact list, select a contact and tap .



Answering a call

To answer a call, drag  on the incoming call screen.

- When the stereo headset is connected, you can make calls by using the call/end button on the headset.
- To end a call simply by pressing the Power/Lock key, tap  > **Tools** > **Settings** > **Networks** > **Call** > **Answer and end calls**, then turn on **End calls with the Power key**.

Rejecting a call

To reject an incoming call, drag  across the incoming call screen.

- To send a rejection message, drag the rejection message option  across the screen.
- To add or edit a rejection message, tap  > **Tools** > **Settings** > **Networks** > **Call** > **Decline and reject calls** > **Decline with message**.
- When a call is coming in, press the Volume Up (+), Volume Down (-) or Power/Lock key to mute ringtone or vibration.

Viewing missed calls

If there is a missed call, the status bar at the top of the screen displays .

To view missed call details, drag the status bar downwards. You can also tap  >  > **Call logs**.

Functions accessible during a call

During a call, you can access a variety of functions by tapping on-screen buttons:

- **Hold:** Place the current call on hold.
- **Contacts:** View the contact list during a call.
- **End:** End a call.
- **Dialpad:** Display or hide the dial pad.
- **Speaker:** Turn on the speakerphone function.
- **Mute:** Mute your voice so that your voice cannot be heard by the other party.
- **Bluetooth:** Switch the call to a Bluetooth device that is paired and connected.
- **⋮** : Access additional call options.



- Available settings items may vary depending on the area or service provider.

Making a three-way calling

You can make a call to another contact during a call.



- 1 During a call, tap **⋮ > Add call**.
- 2 Enter a phone number and tap .
 - The two calls are displayed on the screen at the same time, and the first call is put on hold.
- 3 To start a conference call, tap **Merge calls**.



- You may be charged a fee for each call. Consult with your service provider for more information.

Viewing call records

To view recent call records, tap  >  > **Call logs**. Then, you can use the following functions:



- To view detailed call records, select a contact. To make a call to the selected contact, tap .
- To delete call records, tap  > **Delete**.



- The displayed call duration may differ from the call charge. Consult with your service provider for more information.

Configuring call options

You can configure various call options.

- 1 Tap  >  > **Dial** or **Call logs**.
- 2 Tap  > **Call settings** and then configure the options to suit your preferences.





Messaging

Sending a message

You can create and send messages to your contacts using the Messaging app.



- Sending messages abroad may incur additional charges. Consult with your service provider for more information.

- 1 Tap  > .
- 2 Tap .
- 3 Specify a recipient and create a message.
 - To attach files, tap .
 - To access optional menu items, tap .
- 4 Tap **Send** to send the message.

Reading a message

You can view exchanged messages organized by contact.

- 1 Tap  > .
- 2 Select a contact from the message list.

Configuring messaging settings

You can change messaging settings to suit your preferences.

- 1 Tap  > .
- 2 Tap  > **Settings** from the message list.

Camera

Starting the camera

You can take a photo or record a video to keep the memorable moments.

Tap  > .



- Before taking a photo or recording a video, wipe the camera lens with a soft cloth.
- Be careful not to stain the camera lens with your fingers or other foreign substance.
- If the battery level is lower than 5%, charge the battery before using the camera.
- Images included in this user guide may be different from the actual device.
- Photos and videos can be viewed or edited from the Gallery. See [Gallery overview](#) for details.



- When the screen is turned off or locked, start the camera by pressing the Volume Down (-) key twice. To activate this function, tap  > **Tools > Settings > General** and turn on **Shortcut keys**.

Switching between cameras

You can switch between the front and rear cameras to suit your shooting environment.

On the camera screen, tap  or drag the screen in any direction to switch between the front and rear cameras.

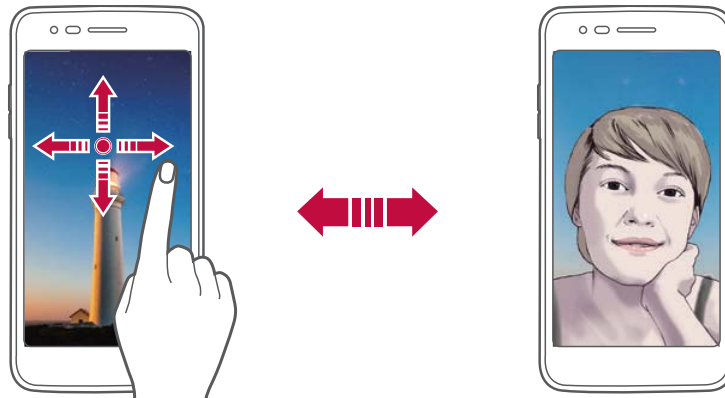

- Use the front camera to take selfies. See [Taking selfies](#) for details.

Zoom in or out

You can use zoom in or out on the camera screen while taking a picture or recording a video.

On the camera screen, pinch or spread two fingers to zoom in or out.





Taking a photo

- 1 Tap the subject to focus the camera on.
- 2 Tap  to take a photo.
You can also press the Volume Down (-) or Volume Up (+) key to take a photo.



- To take quick pictures, you can tap  to hide the screen options, then tap the screen to automatically take a picture.

Recording a video

- 1 Tap the subject to focus the camera on.
- 2 Tap 
 - To take a photo while recording a video, tap .
 - To pause the video recording, tap . To resume the video recording, tap .
- 3 Tap  to end the video recording.

Burst shot

You can take continuous shots of photos to create moving pictures.

Touch and hold .

- Continuous shots are taken at a fast speed while  is held down.

















- Up to thirty (30) continuous photos can be taken.

Customizing camera options

You can customize a variety of camera options to suit your preferences. Tap .



- Available options vary depending on the selected camera (front or rear camera) and the selected shooting mode.

	<p>Select an aspect ratio for photos or quality for videos.</p>
	<p>Obtain photos in vivid colors, and get compensated effects even when they are taken against the light. These functions are provided by the high dynamic range (HDR) technology equipped in the camera of the device.</p>
	<p>Set the timer to automatically take photos after a specified period of time.</p>
	<p>Take photos with voice commands. (Available choices: Cheese, Smile, Whisky, Kimchi or LG)</p>
	<p>Display guide grids so that you can take photos or record videos based on the horizontal and vertical reference lines.</p>
	<p>Set the locations where you want to save photos and videos. These options appear when an external memory card is inserted.</p> <ul style="list-style-type: none"> •  : Save to the internal storage. •  : Save to the external memory card.
	<p>Customize the Auto shot settings. These options appear when using the front camera.</p> <ul style="list-style-type: none"> •  : Take a picture using the Gesture shot feature. •  : Take a picture when the camera detects a face.
	<p>Flip images. These options appear when using the front camera.</p> <ul style="list-style-type: none"> •  : Do not flip the image. •  : Flip the image horizontally.

Taking selfies

You can use the front camera to view your face on the screen and take selfies.



- When using the front camera, you can change in camera options how selfies are taken. See [Customizing camera options](#) for details.

Gesture shot

You can take selfies by using gestures.

Show your palm to the front camera and then clench your fist.

- In three seconds, a photo is taken.

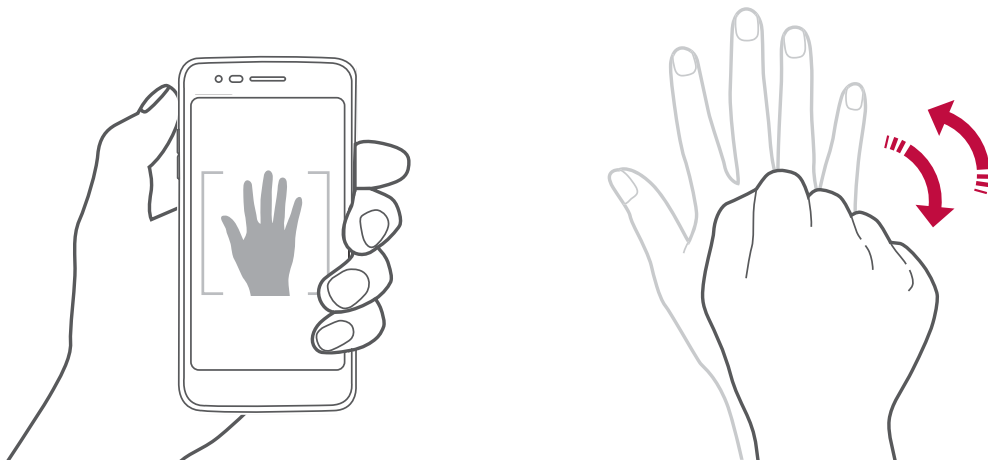

- To use this function, make sure that [👏] is selected in camera options.
- An alternative way to take gesture shots is to clench your fist and then open it towards the front camera.
- Make sure that your palm and fist are within the reference line so that the camera can detect them.

Interval shot

You can take continuous selfies.

While using the front camera, tap and hold . You can also show your palm to the camera, then clench your fist twice quickly.

- Four photos are taken at three second interval.





Auto shot

You can use the face detection feature to take selfies easily and conveniently. You can set the device so that, when you look at the screen, the front camera detects your face and takes a selfie automatically.

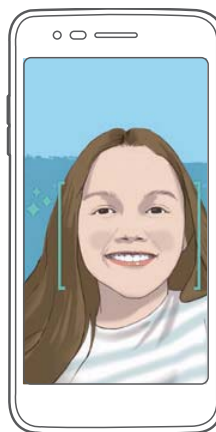
- When the front camera detects your face, the frame turns white. Then if you stop moving, the frame turns blue and the front camera takes a photo.



- Tap , then tap  until  appears to activate the Auto shot function.

Gallery

Gallery overview

You can view and manage photos and videos saved on your device.

1 Tap  > .

- Saved photos and videos are displayed by folder.

2 Tap a folder and select a file.

- View the selected file in full-screen mode.
- While viewing a photo, swipe left or right to view the previous or next photo.
- While viewing a video, swipe left or right to rewind or fast-forward the video.





- Some file formats may not be supported, depending on the installed software and the encoding.
- Files that exceed the size limit may cause an error.

Viewing photos

Back to the  previous screen.

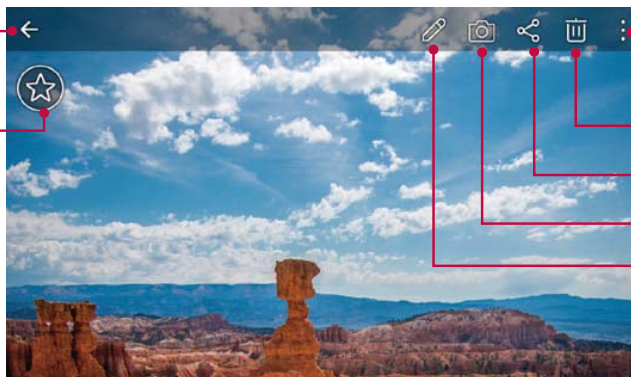
Add to or remove from your favorites. 



 Access additional options.

 Delete images.

 Share images.



 Start the camera.

 Edit images.



- To display the menu items, gently tap the screen. To hide the menu items, tap the screen again.

Editing photos

- 1 While viewing a photo, tap .
- 2 Use a variety of effects and tools to edit the photo.
- 3 Tap  to apply changes.
- 4 Tap **SAVE** to save changes.
 - The changes are overwritten to the original file.
 - To save the edited photo as another file, tap  > **Save copy**.

Playing a video

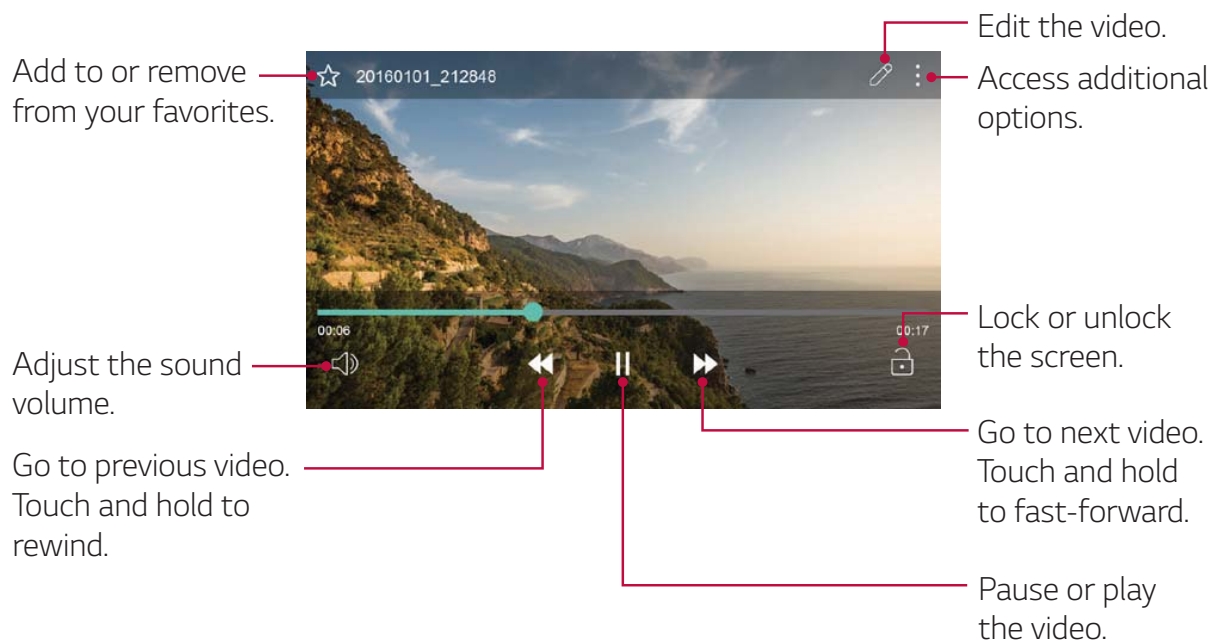

- To adjust the sound volume, drag the right side of the video screen up or down.
- To adjust the screen brightness, drag the left side of the video screen up or down.



Deleting files

You can delete files by using one of the following options:

- Touch and hold a file from the file list, then tap **Delete**.
- Tap  from the file list and delete the desired files.

Sharing files

You can share files by using one of the following options:

- While viewing a photo, tap  to share the file by using the method you want.
- Tap  from the file list to select files and share them using the method you want.

Email

Email overview

You can register an email account to your device and then you can check and send emails from your device.



- If you use mobile data, you may be charged for data usage depending on your pricing plan. Consult with your service provider for more information.

Registering email accounts

When you use the email app for the first time, register your email account.

- 1 Tap  **Email**.
- 2 Select an email service provider.
- 3 Enter your email address and password and then tap **NEXT** to register your account.
 - To manually register an email account, tap **MANUAL SETUP**.

Managing email accounts

To view or edit your email account settings, tap  > **Settings**.

- To add an account, tap **Add account**.
- To delete an account, tap  > **Remove account**.



Opening another email account

If several email accounts are registered and you want to view another account, tap  and select another one from the account list.

Checking email

- 1 Tap  and select a mail box.
- 2 Select an email from the email list.
 - The email message appears.

Sending email



- 1 Tap .
- 2 Enter the recipient's email address.
- 3 Enter a subject and message.
 - To attach files, tap **ATTACH**.
 - To access optional menu items, tap .
- 4 Tap **SEND** to send the email.

Calendar

Calendar overview

You can use the calendar to manage events and tasks.

Adding events

- 1 Tap  > **Calendar**.
- 2 Select a date and then tap .
- 3 Enter event details and tap **SAVE**.
 - If you tap a date from the calendar and the date contains events, a pop-up window appears showing a list of the events. Tap an event from the pop-up window to view the event details.

Syncing events

Tap  > **Calendars to display** >  > **Calendars to sync**.





- When your events are saved from the device to your Google account, they are automatically synced with the Google calendar, too. Then, you can sync other devices with the Google calendar in order to make those devices have the same events that your device has and to manage your events on those devices.

Clock

Alarm

You can set an alarm to trigger it at a specified time.



- 1 Tap  > **Tools** > **Clock** > **Alarm**.
- 2 Tap  to add a new alarm.
- 3 Configure the alarm settings and tap **SAVE**.



- If you select a previously set alarm, you can edit the alarm.
- To delete an alarm, tap  at the top of the screen. You can also touch and hold the alarm.

World clock

You can view the current time in cities around the world.

- 1 Tap  > **Clock** > **World clock**.
- 2 Tap  and add a city.

Timer

You can set the timer to trigger an alarm after a specified period of time.

- 1 Tap  > **Clock** > **Timer**.
- 2 Set the time and tap **Start**.
 - To stop the timer, tap **Stop**. To resume the timer, tap **Resume**.
 - To reset the timer settings, tap **Reset**.

Stopwatch

You can use the stopwatch to record a lap time.

- 1 Tap **○** > **Clock** > **Stopwatch**.
- 2 Tap **Start** to initiate the stopwatch.
 - To record a lap time, tap **Lap**.
- 3 Tap **Stop** to stop the stopwatch.
 - To resume the stopwatch, tap **Resume**.
 - To clear all the lap records and restart the stopwatch, tap **Reset**.

Calculator

You can use two types of calculators: the simple calculator and the scientific calculator.

- 1 Tap **○** > **Tools** > **Calculator**.
- 2 Use the keypad to make a calculation.
 - To use scientific calculator, drag the green colored slide bar located in the right side of the screen to the left.
 - To restart a calculation, touch and hold the **DEL** button.

Downloads

You can view, delete or share files downloaded via the Internet or apps.

Tap **○** > **Tools** > **Downloads**.

File Manager

You can view and manage files saved on your device or cloud.

- 1 Tap  > **Tools** > **File Manager**.
- 2 Tap  and select the desired storage location.

FM Radio

You can listen to FM radio.





Tap  > **FM Radio**.



- To use this app, first connect earphones to the device. The earphones function as the radio antenna.
- This function may not be supported depending on the area.

Voice Recorder

You can record and save your voice or others' voices from important events. Recorded voice files can be played back or shared.

- 1 Tap  > **Tools** > **Voice Recorder**.
 - To save the location details of recording, tap **Location**.
 - To add an event, tap **Event** and add an event to the date you want.
- 2 Tap .
 - To pause recording, tap .
- 3 Tap  to end the recording.
 - The file is saved automatically and the recorded files screen appears.
- 4 Tap  to play the recorded voice.



- If you tap , recorded voice files appear. You can play a recorded voice file from the list.

Contacts

Contacts overview

You can save and manage contacts.

Tap  > **Contacts**.

Adding contacts

Adding new contacts

- 1 On the contact list screen, tap .
- 2 Enter the contact's details and tap **SAVE**.

Importing contacts

You can import contacts from another storage device.

- 1 On the contact list screen, tap  > **Manage contacts** > **Import**.
- 2 Select the source and target locations of the contact you want to import, and then tap **OK**.
- 3 Select the vCard file(s) and tap **IMPORT**.

Adding contacts to the speed dial list

- 1 On the contact list screen, tap  > **Speed dial**.
- 2 Tap **Add contact** from a speed dial number.
- 3 Select a contact.

Searching for contacts

You can search for contacts by using one of the following options:

- On the contact list screen, enter a contact name in the search box.
- Scroll the contact list up or down.
- From the index of the contact list screen, tap the initial letter of a contact.

Contacts list

Editing contacts

- 1 On the contact list screen, select a contact.
- 2 On the contact detail screen, tap  and edit details.
- 3 Tap **SAVE** to save changes.

Deleting contacts

You can delete contacts by using one of the following options:

- On the contact list screen, touch and hold a contact you want to delete, then tap **Delete contact**.
- Tap  > **Delete** on the contact list screen.

Adding favorites

You can register frequently used contacts as favorites.



- 1 On the contact list screen, select a contact.
- 2 On the contact detail screen, tap .

Creating groups

- 1 On the contact list screen, tap **Groups** >  > **New group**.
- 2 Enter a new group name.
- 3 Tap **Add members**, select contacts, then tap **ADD**.
- 4 Tap **SAVE** to save the new group.

Tasks

You can register tasks to your device to easily manage schedules.

- 1 Tap  > **Tools** > **Tasks**.
- 2 Tap  to add a task.
- 3 Enter task details and then tap **SAVE**.

LG Backup

You can back up, restore and move the data saved on your device.

- 1 Tap  > **Tools** > **Settings** > **General** > **Backup & reset** > **LG Backup**.
- 2 Follow the on-screen instructions to select whether to back up data in the preset backup folder on the device or to copy data to other devices.



- Resetting your device may delete backup files saved in internal storage. To minimize data loss, copy important backup files from the LG Backup folder in the internal storage to a computer or external storage.



- Data in a Google account will not be backed up. When you synchronize your Google account, Google apps, Google contacts, Google calendar, Google memo app data and apps downloaded from Play store are stored on the Drive app automatically.
- Backup files are saved with the file extension *.lbf under the LG Backup folder on the memory card or internal storage.
- Fully charge the battery before backing up or restoring data to avoid unintentional powering off during the process.

Google apps

You can use Google apps by setting a Google account. The Google account registration window appears automatically when you use a Google app for the first time. If you do not have a Google account, create one from your device. For details on how to use an app, see the Help in the app.



• Some apps may not work depending on the area or service provider.

Chrome

Sign in to Chrome and import opened tabs, bookmarks and address bar data from a computer to your device.

Docs

Create documents or edit documents created online or from another device. Share and edit documents together with others.

Drive

Upload, save, open, share and organize files from your device. Files accessible from apps can be accessed from anywhere, including online and offline environments.

Duo

Duo is a one-to-one video calling app for everyone.

Gmail

Register your Google email account to your device to check or send email.

Google

Use Google to search for web pages, images, news and more by entering or speaking keywords.

Maps

Find your location or the location of a place on the map. View geographical information.

Photos

View or share photos or albums saved on your device.

Play Movies & TV

Use your Google account to rent or purchase movies. Purchase content and play it anywhere.

Play Music

Purchase music files from the Play Store. Play music files saved on your device.

Sheets

Create spreadsheets or edit spreadsheets created online or from another device. Share and edit spreadsheets together with others.

Slides

Create presentation material or edit presentation material created online or from another device. Share and edit presentation material together with others.

YouTube

Search and play videos. Upload videos on YouTube to share them with people around the world.



04



Phone Settings

Settings

You can customize the device settings in accordance with your preferences.

Tap  > **Tools** > **Settings**.



- Tap  and enter a keyword in the search box to access a setting item.
- Tap  to change the view mode. This user guide assumes that you are using the **Tab view**.

Networks

Airplane mode

You can turn off the call and mobile data functions. When this mode is on, functions that do not involve data, such as games and music playback, remain available.

- 1 On the settings screen, tap **Networks** > **Airplane mode**.
- 2 Tap **OK** in the confirmation screen.

Wi-Fi

You can connect to nearby devices over a Wi-Fi network.

Connecting to a Wi-Fi network

- 1 On the settings screen, tap **Networks** > **Wi-Fi**.
- 2 Drag  to activate it.
 - Available Wi-Fi networks appear automatically.

3 Select a network.

- You may need to enter the network's Wi-Fi password.
- The device skips this process for previously accessed Wi-Fi networks. If you do not want to automatically connect to a certain Wi-Fi network, touch and hold the network and then tap **Forget network**.

Wi-Fi Direct

You can connect your device to other devices that support Wi-Fi Direct to share data directly with them. You do not need an access point. You can connect with more than two devices by using Wi-Fi Direct.

1 On the settings screen, tap **Networks > Wi-Fi > ⋮ > Advanced Wi-Fi > Wi-Fi Direct**.

- Nearby devices that support Wi-Fi Direct automatically appear.

2 Select a device.

- Connection occurs when the device accepts the connection request.



- The battery may drain faster when using Wi-Fi Direct.

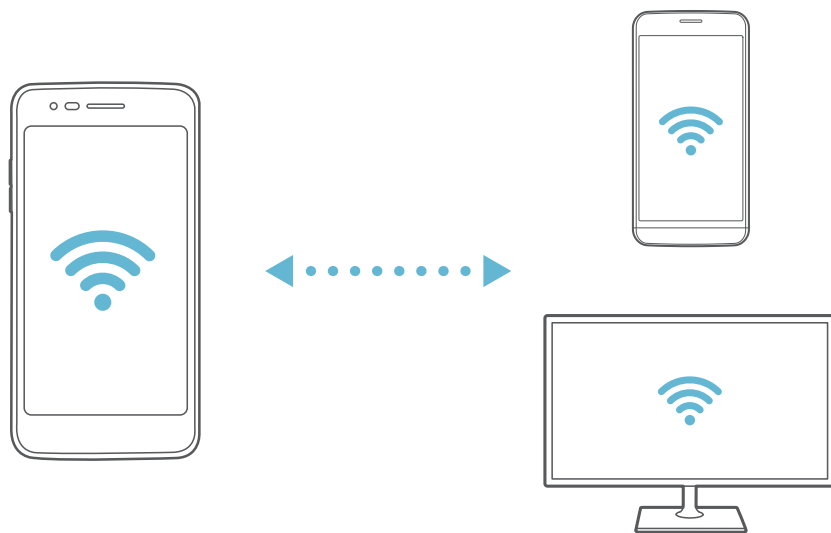

Bluetooth

You can connect your device to nearby devices that support Bluetooth to exchange data with them. Connect your device to a Bluetooth headset and a keyboard. This makes it easier to control the device.

Pairing with another device

- 1 On the settings screen, tap **Networks > Bluetooth**.
- 2 Drag  to activate it.
 - Available devices appear automatically.
 - To refresh the device list, tap **SEARCH**.



• Only devices set as visible are displayed on the list.

- 3 Select a device from the list.
- 4 Follow the on-screen instructions to perform authentication.



• This step is skipped for previously accessed devices.

Sending data via Bluetooth

- 1 Select a file.
 - You can send multimedia files or contacts.
- 2 Tap  > **Bluetooth**.
- 3 Select a target device for the file.
 - The file is sent as soon as the target device accepts it.



• File sharing processes may differ, depending on the file.

Data Manager

You can turn mobile data on or off. You can also manage mobile data usage.

Turning on mobile data

- 1 On the settings screen, tap **Networks > Data Manager**.
- 2 Drag  to activate it.

Customizing mobile data settings

- 1 On the settings screen, tap **Networks > Data Manager**.
- 2 Customize the following settings:
 - **Mobile data:** Turn on to use data connections on mobile networks.
 - **Limit mobile data usage:** Set a limit for mobile data usage to block mobile data if the limit is reached.
 -  : Customize mobile data settings.

Call

You can customize call settings, such as voice call and international call options.



- Some features may not be supported depending on the area or service provider.

- 1 On the settings screen, tap **Networks > Call**.
- 2 Customize the desired settings.

Mobile Hotspot & Tethering

USB tethering

You can connect the device to another device via USB and share mobile data.

- 1 Connect your device and other devices via USB cable.
- 2 On the settings screen, tap **Networks > Mobile Hotspot & Tethering > USB tethering** and then drag to activate it.



- This option uses mobile data and may incur data usage fees, depending on your pricing plan. Consult with your service provider for more information.
- When connecting to a computer, download the USB driver from www.lg.com and install it on the computer.
- You cannot send or receive files between your device and a computer while USB tethering is turned on. Turn off USB tethering to send or receive files.
- Operating systems that support tethering are Window XP or higher, or Linux.

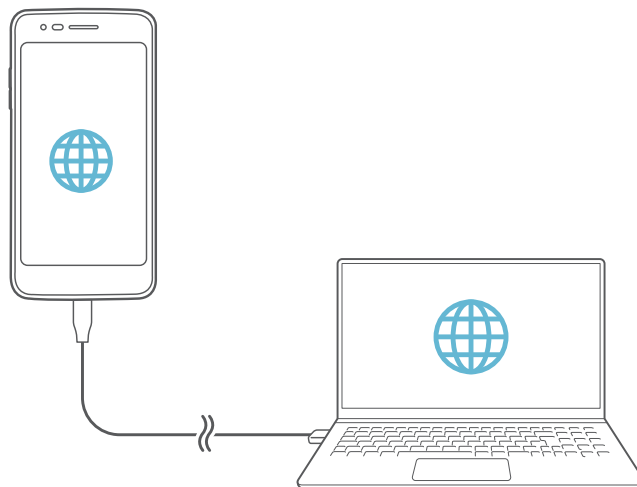

Mobile Hotspot

You can set the device as a wireless router so that other devices can connect to the Internet by using your device's mobile data.

- 1 On the settings screen, tap **Networks > Mobile Hotspot & Tethering > Mobile Hotspot** and then drag  to activate it.
- 2 Tap **Set up Mobile Hotspot** and enter the Wi-Fi name (SSID) and password.
- 3 Turn on Wi-Fi on the other device, and select the name of the device network on the Wi-Fi list.
- 4 Enter the network password.



- This option uses mobile data and may incur data usage fees, depending on your pricing plan. Consult with your service provider for more information.
- More information is available at this web site: <http://www.android.com/tether#wifi>



Help

You can view help on using tethering and hotspots.

On the settings screen, tap **Networks > Mobile Hotspot & Tethering > Help**.

More

Mobile networks

You can customize the mobile network settings.

- 1 On the settings screen, tap **Networks > More > Mobile networks**.
- 2 Customize the following settings:
 - **Mobile data:** Turn mobile data on or off.
 - **International data roaming:** Turn data roaming on or off.
 - **Disable 2G:** Allows you to disable 2G service on your phone.
 - **Access Point Names:** View or change the access point for using mobile data services. To change the access point, select a choice from the access point list.
 - **Network operators:** Select a network operator.

VPN

You can connect to a safe virtual network, such as an intranet. You can also manage connected virtual private networks.

Adding VPN

- 1 On the settings screen, tap **Networks > More > VPN**.
- 2 Tap **Add VPN**.



- If the screen is not locked, a notification screen appears. Tap **SETTINGS** from the notification screen and lock the screen. See [Setting a screen lock](#) for details.

- 3 Enter VPN details and tap **SAVE**.

Configuring VPN settings

- 1 Tap a VPN from the **VPNS** list.
- 2 Enter the VPN user account details and tap **CONNECT**.
 - To save the account details, select the **Save account information** checkbox.

Emergency alerts

If emergency alerts are issued, those alerts will appear on this menu. On the settings screen, tap **Networks > More > Emergency alerts**.

Printing

You can connect your device to a Bluetooth printer and print photos or documents saved on the device.

- 1 On the settings screen, tap **Networks > More > Printing**.



- If the desired printer is not in the list, install the printer driver from the app store.

- 2 Select a print service.
- 3 Drag to activate it.
- 4 Select a printer from the printer list screen.
 - To add a printer, tap **: > Add printer**.
 - To search for a printer name, tap **: > Search**.
 - Tap **: > Settings** from the printer list screen.
- 5 Select a file and tap **: > Print**.
 - The document prints.



- If you do not have a Google account, tap **ADD ACCOUNT** to create an account.

Sound & notification

You can customize sound, vibrate and notification settings.

On the settings screen, tap **Sound & notification** and customize the following settings:

- **Sound profile:** Change the sound mode to sound, silent, or vibrate only.
- **Volume:** Adjust the sound volume for various items.
- **Ringtone:** Select a ringtone for incoming calls. Add or delete ringtones.
- **Ringtone ID:** Create a ringtone for an incoming call from a particular contact.
- **Sound with vibration:** Set the device to vibrate and play a ringtone simultaneously.
- **Vibration type:** You can select a vibration type or make your own vibration pattern.
- **Do not disturb:** Set the time, range and app type to receive notification messages. Receive notification messages only on particular days of the week.
- **Lock screen:** Display or hide a notification message on the lock screen. You can also hide private information.
- **Apps:** Select the apps that can show their notification messages on the screen and set the priorities of those apps in regard to notification messages.
- **More > Default notification sound:** Select a notification ringtone. Set music saved on the device as a notification ringtone.
- **More > Vibrate on tap:** Set the device to vibrate when you tap certain items on the screen.
- **More > Sound effects:** Select a sound effect to play when you tap the dialpad or keyboard, select an option, or lock or unlock the screen.
- **More > Message/call voice notifications:** Set the device to read the caller information or message content via voice.

Display

You can customize detailed settings for each screen type.

On the settings screen, tap **Display** and customize the following settings:

- **Home screen:** Customize settings for the Home screen. See [Home screen settings](#) for details.
- **Lock screen:** Customize lock screen settings. See [Lock screen settings](#) for details.
- **Home touch button combination:** Rearrange Home touch buttons or change their background colors.
- **Font type:** Change the font face.
- **Font size:** Change the font size.
- **Bold text:** Bold the text on the screen.
- **Brightness:** Use the slide bar to change the device's screen brightness. To automatically adjust screen brightness according to ambient light intensity, tap the **Auto** switch.
- **Auto-rotate screen:** Automatically rotate the screen according to the device's orientation.
- **Screen timeout:** Automatically turn off the screen when the device is left idle for a specified period of time.
- **More > Daydream:** Display a screen saver when the device is connected to the holder or charger. Select a screen saver type to display.
- **More > Motion sensor calibration:** Correct the angle and speed of the motion sensor to improve the tilt accuracy and speed of the sensor.



- When correcting the motion sensor, make sure to place the device on a flat surface. Failure to do so may cause an error with the motion sensor functions, such as automatic screen rotation.

General

Language & keyboard

You can customize language and keyboard settings for your device.

- 1 On the settings screen, tap **General > Language & keyboard**.
- 2 Customize the following settings:
 - **Language:** Select a language to apply for the device.
 - **Spelling correction:** Allows you to set various options for the Google Spell Checker.
 - **Current keyboard:** View the keyboard currently in use. Select a keyboard to use when entering text.
 - **LG Keyboard:** Customize the LG keyboard settings.
 - **Google voice typing:** Configure the options for text dictation by Google.
 - **Text-to-speech output:** Configure the settings for text-to-speech output.
 - **Pointer speed:** Adjust the pointer speed of a mouse or trackpad.
 - **Reverse buttons:** Reverse the right mouse button to perform primary direct-manipulation actions.

Location

You can customize how your location information is used by particular apps.

- 1 On the settings screen, tap **General > Location**.
- 2 Customize the following settings:
 - **Mode:** Select a method to provide your location information.
 - **RECENT LOCATION REQUEST:** View apps that recently requested location information.

- **Low power location estimation:** Estimate the device location by using low power consumption.
- **Camera:** Save location information when taking photos or recording videos.
- **Google Location History:** Configure the Google location history settings.

Accounts & sync

You can add or manage accounts, including a Google account. You can also sync particular apps or user information automatically.

- 1 On the settings screen, tap **General > Accounts & sync**.
- 2 Customize the following settings:
 - **Auto-sync data:** Sync all the registered accounts automatically.
 - **ACCOUNTS:** View a list of registered accounts. To view or change details of an account, tap the account.
 - **ADD ACCOUNT:** Add accounts.

Accessibility

You can manage accessibility plug-ins installed on your device.

- 1 On the settings screen, tap **General > Accessibility**.
- 2 Customize the following settings:
 - **Vision > TalkBack:** Set the device to notify screen status or actions via voice.
 - **Vision > Message/call voice notifications:** Set the device to read the caller information or message content via voice.
 - **Vision > Font size:** Change the font size.
 - **Vision > Bold text:** Bold the text on the screen.
 - **Vision > Touch zoom:** Zoom in or out by tapping the screen three times.
 - **Vision > Screen color inversion:** Increase the display color contrast for people with low vision.

- **Vision > Screen color adjustment:** Adjust the display color.
- **Vision > Grayscale:** Switch the screen to grayscale mode.
- **Vision > End calls with the Power key:** End a call by pressing the Power/Lock key.
- **Hearing > Captions:** Turn on the subtitle service when playing videos for the hearing impaired.
- **Hearing > Flash alerts:** Set the device to notify you with a blinking light for incoming calls and alarms.
- **Hearing > Turn off all sounds:** Mute all sounds and lower volume on the receiver.
- **Hearing > Audio type:** Select the audio type.
- **Hearing > Sound balance:** Adjust the audio output balance. Use the slide bar to change the balance.
- **Motor & cognition > Touch assistant:** Turn on the touch board to make buttons and gestures easier to use.
- **Motor & cognition > Touch and hold delay:** Adjust the touch input time.
- **Motor & cognition > Touch and hold for calls:** Answer or decline calls by touching and holding the call button instead of dragging it.
- **Motor & cognition > Screen timeout:** Turn off the screen automatically when the device is left idle for a specified period of time.
- **Motor & cognition > Touch control areas:** Limit the touch area so that only a particular portion of the screen can be controlled by touch input.
- **Accessibility features shortcut:** Quickly access a frequently used function by tapping  three times.
- **Auto-rotate screen:** Automatically change the screen orientation according to the physical position of the device.
- **Switch Access:** Create key combinations to control your device.

Shortcut keys

You can use the volume keys to directly launch apps when the screen is turned off or locked.

- 1 On the settings screen, tap **General > Shortcut keys**.
- 2 Drag  to activate it.
 - Press the Volume Down (-) key twice to launch the **Camera** app when the screen is locked or turned off. Press the Volume Up (+) key twice to launch **Capture+**.

Google services

You can use Google settings to manage your Google apps and account settings.

On the settings screen, tap **General > Google services**.

Security

- 1 On the settings screen, tap **General > Security**.
- 2 Customize the following settings:
 - **Lock screen:** Allow you to select a screen lock and set its options.
 - **Content lock:** Set the method to lock files in QuickMemo+.
 - **Encrypt phone:** Set the device password for privacy. Create a PIN or password to enter each time the device is turned on.
 - **Encrypt SD card:** Encrypt the memory card to prevent use on another device. See *Memory card encryption* for details.
 - **Set up SIM card lock:** Lock or unlock the SIM card, or change the password (PIN).
 - **Password typing visible:** Display a password as you enter it.
 - **Phone administrators:** Allow privileges to restrict the control or use of the device to particular apps.
 - **Unknown sources:** Allow the installation of apps from non-Play Store apps.

- **Verify apps:** Block the installation of harmful apps. Display a warning message when a harmful app is installed.
- **Credential protection:** View the type of credential protection currently used.
- **Certificate management:** Manage the security certificate saved on the device.
- **Trust agents:** View and use trust agents installed on the device.
- **Screen pin:** Fix the app screen so that only the currently active app can be used.
- **Usage access for apps:** View details on usage of apps on the device.

Date & time

You can customize date and time settings for your device.

- 1 On the settings screen, tap **General > Date & time**.
- 2 Customize the desired settings.

Storage & USB

You can view and manage internal storage on the device or storage space of the memory card.

- 1 On the settings screen, tap **General > Storage & USB**.
- 2 Customize the following settings:
 - **Internal storage:** View the total storage space and free space in the device's internal storage. View a list of apps in use and the storage capacity for each app.
 - **SD card:** View the total storage space and free space in the memory card. This option appears only when a memory card is inserted. To unmount the memory card, tap .

Battery & power saving

You can view the current battery information or turn on power-saving mode.

- 1 On the settings screen, tap **General > Battery & power saving**.
- 2 Customize the following settings:
 - **Battery usage:** View the battery usage details. To view more details, select a specific item.
 - **Battery percentage on status bar:** Display the remaining battery level as a percentage on the status bar.
 - **Battery saver:** Reduce battery consumption by cutting down some device settings, such as the display brightness, speed and vibration intensity. The status bar displays  when power-saving mode is on.
 - **Help:** Displays help information for the battery saver feature.

Memory

You can view the average amount of memory usage over a certain period of time and the memory occupied by an app.

- 1 On the settings screen, tap **General > Memory**.
- 2 Tap ▼ to set a time slot to retrieve data.

Apps

You can view a list of installed apps. Stop apps from running or delete apps, if necessary.

- 1 On the settings screen, tap **General > Apps**.
- 2 Select an app and perform actions.

Backup & reset

You can back up data saved on your device to another device or account. Reset the device, if necessary.

- 1 On the settings screen, tap **General > Backup & reset**.
- 2 Customize the following settings:
 - **LG Backup:** Back up or restore the blocked sender list, messages, images, home screens and other data saved on the device. See [LG Backup](#) for details.
 - **Back up my data:** Back up your app data, Wi-Fi password and other settings to the Google server.
 - **Backup account:** View the current backup account in use.
 - **Automatic restore:** Automatically restore backup settings and data when reinstalling an app.
 - **Network settings reset:** Reset Wi-Fi, Bluetooth and other network settings.
 - **Factory data reset:** Reset all settings for the device and delete data.



- Resetting your device deletes all data on it. Enter your device name, Google account and other initial information again.

About phone

You can view information about your device, such as the name, status, software details and legal information.

On the settings screen, tap **General > About phone** and view information.



Appendix

Phone software update

LG Mobile phone software update from the Internet

For more information about using this function, please visit <http://www.lg.com/common/index.jsp>, select your country and language.

This feature allows you to conveniently update the firmware on your phone to a newer version from the Internet without needing to visit a service center. This feature will only be available if and when LG makes a newer firmware version available for your device.

Because the mobile phone firmware update requires the user's full attention for the duration of the update process, please make sure you check all instructions and notes that appear at each step before proceeding. Please note that removing the USB cable during the upgrade may seriously damage your mobile phone.



- LG reserves the right to make firmware updates available only for selected models at its own discretion and does not guarantee the availability of the newer version of the firmware for all handset models.

LG Mobile Phone software update via Over-the-Air (OTA)

This feature allows you to conveniently update your phone's software to a newer version via OTA, without connecting a USB cable. This feature will only be available if and when LG makes a newer firmware version available for your device.

First check the software version on your mobile phone:

Tools > Settings > General > About phone > Software Update > Update now.



- Your personal data from internal phone storage—including information about your Google account and any other accounts, your system/application data and settings, any downloaded applications and your DRM license—might be lost in the process of updating your phone's software. Therefore, LG recommends that you backup your personal data before updating your phone's software. LG does not take responsibility for any loss of personal data.
- This feature depends on the area or service provider.

FAQ

This chapter lists some problems you might encounter when using your phone. Some problems require you to call your service provider, but most are easy to fix yourself.

Message	Possible causes	Possible corrective measures
SIM card error	There is no SIM card in the phone or it is inserted incorrectly.	Make sure the SIM card is correctly inserted.
No network connection/ Dropped network	Signal is weak or you are outside the carrier network.	Move toward a window or into an open area. Check the network operator coverage map.
	Operator applied new services.	Check whether the SIM card is more than 6-12 months old. If so, change your SIM or USIM card at your network provider's nearest branch. Contact your service provider.
Codes do not match	To change a security code, confirm the new code by re-entering it.	If you forget the code, contact your service provider.
	The two codes you entered do not match	
No applications can be set	Not supported by service provider or registration required.	Contact your service provider.
Downloaded application causes a lot of errors.	Remove the application.	<ol style="list-style-type: none"> 1. Tap  > Tools > Settings. 2. Tap General > Apps. 3. Tap the app > Uninstall.

Message	Possible causes	Possible corrective measures
Calls not available	Dialing error	New network not authorized.
	New SIM card inserted.	Check for new restrictions.
	Pre-paid charge limit reached.	Contact service provider or reset the limit with PIN2.
Phone cannot be turned on	On/Off key pressed too briefly.	Press the On/Off key for at least two seconds.
	Battery is not charged.	Charge battery. Check the charging indicator on the display.
Charging error	Battery is not charged.	Charge battery.
	Outside temperature is too hot or cold.	Make sure phone is charging at a normal temperature.
	Contact problem	Check the charger and its connection to the phone.
	No voltage	Plug the charger into a different outlet.
	Charger defective	Replace the charger.
	Wrong charger	Use only original LG accessories.
Number not allowed.	The Fixed dialing number function is on.	Check the Settings menu and turn the function off.
Impossible to receive/ send SMS & photos	Memory full	Delete some data, such as applications or messages from your phone to make more memory available.

Message	Possible causes	Possible corrective measures
Files do not open	Unsupported file format	Check the supported file formats.
The screen does not turn on when I receive a call.	Proximity sensor problem	If you use a protection tape or case, make sure it has not covered the area around the proximity sensor. Make sure that the area around the proximity sensor is clean
No sound	Vibration mode	Check the settings status in the sound menu to make sure you are not in vibration or no interruptions mode.
Hangs up or freezes	Intermittent software problem	If the screen freezes or the phone does not respond when you try to operate it, remove the battery and reinsert it. Then power the phone back on. Alternatively, try to perform a software update through the website.

Anti-Theft Guide

Set up your device to prevent other people from using it if it's been reset to factory settings without your permission. For example, if your device is lost, stolen, or wiped, only someone with your Google account or screen lock information can use the device.

All you need to make sure your device is protected is:

- Set a screen lock: If your device is lost or stolen but you have a screen lock set, the device can't be erased using the Settings menu unless your screen is unlocked.
- Add your Google account on your device: If your device is wiped but you have your Google account on it, the device can't finish the setup process until your Google account information is entered again.

After your device is protected, you'll need to either unlock your screen or enter your Google account password if you need to do a factory reset. This ensures that you or someone you trust is doing the reset.



- Do not forget your Google account and password you had added to your device prior to performing a factory reset. If you can't provide the account information during the setup process, you won't be able to use the device at all after performing the factory reset.

More information

Open Source Software Notice Information

To obtain the source code under GPL, LGPL, MPL, and other open source licenses, that is contained in this product, please visit <http://opensource.lge.com>.

In addition to the source code, all referred license terms, warranty disclaimers and copyright notices are available for download.

LG Electronics will also provide open source code to you on CD-ROM for a charge covering the cost of performing such distribution (such as the cost of media, shipping, and handling) upon email request to opensource@lge.com. This offer is valid for three (3) years from the date on which you purchased the product.

Trademarks

- Copyright ©2017 LG Electronics, Inc. All rights reserved. LG and the LG logo are registered trademarks of LG Group and its related entities.
- Google™, Google Maps™, Gmail™, YouTube™, Hangouts™ and Play Store™ are trademarks of Google, Inc.
- Bluetooth® is a registered trademark of Bluetooth SIG, Inc. worldwide.
- Wi-Fi® and the Wi-Fi logo are registered trademarks of the Wi-Fi Alliance.
- All other trademarks and copyrights are the property of their respective owners.



For Your Safety

Important Information

This user guide contains important information on the use and operation of this phone. Please read all the information carefully for optimal performance and to prevent any damage to or misuse of the phone. Any changes or modifications not expressly approved in this user guide could void your warranty for this equipment. Any changes or modifications not expressly approved by the manufacturer could void the user's authority to operate the equipment.

Before You Start

Warning Violation of the instructions may cause serious injury or death.

WARNING: This product contains chemicals known to the State of California to cause cancer and birth defects or other reproductive harm.

Wash hands after handling.



- Never place your phone in a microwave oven as it will cause the battery to explode.



- When riding in a car, do not leave your phone or set up the hands-free kit near the air bag. If wireless equipment is improperly installed and the air bag is deployed, you may be seriously injured.
- Do not dispose of your phone near fire or with hazardous or flammable waste. You should dispose of your phone in accordance with all applicable laws.



- Do not use the phone in areas where its use is prohibited. (For example: aircraft)

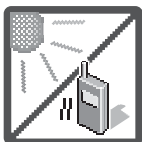

- Do not expose the battery charger or adapter to direct sunlight or use it in places with high humidity, such as a bathroom.



- Do not use harsh chemicals (such as alcohol, benzene, thinners, etc.) or detergents to clean your phone. This could cause a fire.



- Do not drop, strike, or shake your phone severely. It may harm the internal circuit boards of the phone.



- Do not use your phone in high explosive areas as the phone may generate sparks.



- Do not damage the power cord by bending, twisting, pulling, or heating. Do not use the plug if it is loose as it may cause electric shock or fire.

- Do not place any heavy items on the power cord. Do not allow the power cord to be crimped as it may cause electric shock or fire.

- Do not handle the phone with wet hands while it is being charged. It may cause an electric shock or seriously damage your phone.



- Do not disassemble the phone.
- Do not place or answer calls while charging the phone as it may short-circuit the phone and/or cause electric shock or fire.
- Do not attempt to repair or modify the device yourself.
- You should never attempt to open or disassemble this device yourself and doing so may cause damage that voids your warranty.



- Make sure that no sharp-edged items, such as animal's teeth or nails, come into contact with the battery. This could cause a fire.



- Be careful that children do not swallow any parts (such as earphone, connection parts of the phone, etc.) This could cause asphyxiation or suffocation resulting in serious injury or death.



- Unplug the power cord and charger during lightning storms to avoid electric shock or fire.



- Only use chargers provided by LG. The warranty will not be applied to products provided by other suppliers.
- Only authorized personnel should service the phone and its accessories. Faulty installation or service may result in accidents and consequently invalidate the warranty.



- An emergency call can be made only within a service area. For an emergency call, make sure that you are within a service area and that the phone is turned on.

- Your phone is an electronic device that generates heat during normal operation. Extremely prolonged, direct skin contact in the absence of adequate ventilation may result in discomfort or minor burns. Therefore, use care when handling your phone during or immediately after operation.
- Use and store your phone in temperatures between 0 °C/32 °F and 45 °C/113 °F, if possible. Exposing your phone to extremely low or high temperatures may result in damage, malfunction, or even explosion.

HAC statement

This phone has been tested and rated for use with hearing aids for some of the wireless technologies that it uses. However, there may be some newer wireless technologies used in this phone that have not been tested yet for use with hearing aids. It is important to try the different features of this phone thoroughly and in different locations, using your hearing aid or cochlear implant, to determine if you hear any interfering noise. Consult your service provider or the manufacturer of this phone for information on hearing aid compatibility. If you have questions about return or exchange policies, consult your service provider or phone retailer. This mobile phone has a Hearing Aid Mode that, when activated, may reduce interference with some hearing aid models.

FCC RF Exposure Information

WARNING! Read this information before operating the phone.

In August 1996, the Federal Communications Commission (FCC) of the United States, with its action in Report and Order FCC 96-326, adopted an updated safety standard for human exposure to Radio Frequency (RF) electromagnetic energy emitted by FCC regulated transmitters. Those guidelines are consistent with the safety standard previously set by both U.S. and international standards bodies. The design of this phone complies with the FCC guidelines and these international standards.

Body-worn Operation

This device was tested for typical use with the back of the phone kept 0.39 inches (1.0 cm) from the body. To comply with FCC RF exposure requirements, a minimum separation distance of 0.39 inches (1.0 cm) must be maintained between the user's body and the back of the phone.

Any belt-clips, holsters, and similar accessories containing metallic components may not be used. Avoid the use of accessories that cannot maintain 0.39 inches (1.0 cm) distance between the user's body and the back of the phone and have not been tested for compliance with FCC RF exposure limits.

Consumer Information About Radio Frequency Emissions

Your wireless phone, which contains a radio transmitter and receiver, emits radio frequency energy during use. The following consumer information addresses commonly asked questions about the health effects of wireless phones.

Are wireless phones safe?

Scientific research on the subject of wireless phones and radio frequency ("RF") energy has been conducted worldwide for many years, and continues. In the United States, the Food and Drug Administration ("FDA") and the Federal Communications Commission ("FCC") set policies and procedures for wireless phones. The FDA issued a website publication on health issues related to cell phone usage where it states, "The scientific community at large ... believes that the weight of scientific evidence does not show an association between exposure to radiofrequency (RF) from cell phones and adverse health outcomes. Still the scientific community does recommend conducting additional research to address gaps in knowledge. That research is being conducted around the world and FDA continues to monitor developments in this field. You can access the joint FDA/FCC website at <http://www.fda.gov> (under "c" in the subject index, select Cell Phones > Research). You can also contact the FDA toll-free at (888) 463-6332 or (888) INFO-FDA.

In June 2000, the FDA entered into a cooperative research and development agreement through which additional scientific research is being conducted. The FCC issued its own website publication stating that “there is no scientific evidence that proves that wireless phone usage can lead to cancer or a variety of other problems, including headaches, dizziness or memory loss.” This publication is available at <http://www.fcc.gov/cgb/cellular.html> or through the FCC at (888) 225-5322 or (888) CALL-FCC.

What does “SAR” mean?

In 1996, the FCC, working with the FDA, the U.S. Environmental Protection Agency, and other agencies, established RF exposure safety guidelines for wireless phones in the United States. Before a wireless phone model is available for sale to the public, it must be tested by the manufacturer and certified to the FCC that it does not exceed limits established by the FCC. One of these limits is expressed as a Specific Absorption Rate, or “SAR.” SAR is a measure of the rate of absorption of RF energy in the body. Tests for SAR are conducted with the phone transmitting at its highest power level in all tested frequency bands. Since 1996, the FCC has required that the SAR of handheld wireless phones not exceed 1.6 watts per kilogram, averaged over one gram of tissue. Although the SAR is determined at the highest power level, the actual SAR value of a wireless phone while operating can be less than the reported SAR value. This is because the SAR value may vary from call to call, depending on factors such as proximity to a cell site, the proximity of the phone to the body while in use, and the use of hands-free devices.

For more information about SARs, visit the FCC website at <https://www.fcc.gov/consumers/guides/specific-absorption-rate-sar-cell-phones-what-it-means-you>. You may also wish to contact the manufacturer of your phone.

Can I minimize my RF exposure?

If you are concerned about RF, there are several simple steps you can take to minimize your RF exposure. You can, of course, reduce your talk time.

You can place more distance between your body and the source of the RF, as the exposure level drops off dramatically with distance. The FDA/FCC website states that “hands-free kits can be used with wireless phones for convenience and comfort. These systems reduce the absorption of RF energy in the head because the phone, which is the source of the RF emissions, will not be placed against the head. On the other hand, if the phone is mounted against the waist or other part of the body during use, then that part of the body will absorb more RF energy. Wireless phones marketed in the U.S. are required to meet safety requirements regardless of whether they are used against the head or against the body. Either configuration should result in compliance with the safety limit.” Also, if you use your wireless phone while in a car, you can use a phone with an antenna on the outside of the vehicle. You should also read and follow your wireless phone manufacturer’s instructions for the safe operation of your phone.

Do wireless phones pose any special risks to children?

The FDA/FCC website states that “the scientific evidence does not show a danger to users of wireless communication devices, including children.” The FDA/FCC website further states that “some groups sponsored by other national governments have advised that children be discouraged from using wireless phones at all.” For example, the Stewart Report from the United Kingdom [“UK”] made such a recommendation in December 2000. In this report a group of independent experts noted that no evidence exists that using a cell phone causes brain tumors or other ill effects. [The UK’s] recommendation to limit cell phone use by children was strictly precautionary; it was not based on scientific evidence that any health hazard exists. A copy of the UK’s leaflet is available at <http://www.dh.gov.uk> (search “mobile”), or you can write to: NRPB, Chilton, Didcot, Oxon OX11 0RQ, United Kingdom. Copies of the UK’s annual reports on mobile phones and RF are available online at <http://www.hpa.org.uk/radiation/> (search “mobile”). Parents who wish to reduce their children’s RF exposure may choose to restrict their children’s wireless phone use.

Where can I get further information about RF emissions?

For further information, see the following additional resources (websites current as of April 2005):

U.S. Food and Drug Administration

FDA Consumer magazine

November-December 2000

Telephone: (888) INFO-FDA

<http://www.fda.gov> (Under "c" in the subject index, select Cell Phones > Research.)

U.S. Federal Communications Commission

445 12th Street, S.W.

Washington, D.C. 20554

Telephone: (888) 225-5322

<http://www.fcc.gov/oet/rfsafety>

Royal Society of Canada Expert Panels on Potential Health Risks of Radio Frequency Fields from Wireless Telecommunication Devices

283 Sparks Street

Ottawa, Ontario K1R 7X9

Canada

Telephone: (613) 991-6990

http://www.rsc.ca/index.php?page=Expert_Panels_RF&Lang_id=120

World Health Organization

Avenue Appia 20

1211 Geneva 27

Switzerland

Telephone: 011 41 22 791 21 11

<http://www.who.int/mediacenter/factsheets/fs193/en/>

International Commission on Non-Ionizing Radiation Protection

c/o Bundesamt für Strahlenschutz

Ingolstaedter Landstr. 1

85764 Oberschleissheim

Germany

Telephone: 011 49 1888 333 2156

<http://www.icnirp.de>

American National Standards Institute

1819 L Street, N.W., 6th Floor

Washington, D.C. 20036

Telephone: (202) 293-8020

<http://www.ansi.org>

National Council on Radiation Protection and Measurements

7910 Woodmont Avenue, Suite 800

Bethesda, MD 20814-3095

Telephone: (301) 657-2652

<http://www.ncrponline.org>

Engineering in Medicine and Biology Society, Committee on Man and Radiation (COMAR) of the Institute of Electrical and Electronics Engineers

<http://ewh.ieee.org/soc/embs/comar/>

Consumer Information on SAR

(Specific Absorption Rate)

This model phone meets the government's requirements for exposure to radio waves. Your wireless phone is a radio transmitter and receiver. It is designed and manufactured not to exceed the emission limits for exposure to Radio Frequency (RF) energy set by the Federal Communications Commission of the U.S. Government. These limits are part of comprehensive guidelines and establish permitted levels of RF energy for the general population. The guidelines are based on standards that were developed by independent scientific organizations through periodic and thorough evaluation of scientific studies. The standards include a substantial safety margin designed to assure the safety of all persons, regardless of age and health.

The exposure standard for wireless mobile phones employs a unit of measurement known as the Specific Absorption Rate, or SAR. The SAR limit set by the FCC is 1.6 W/kg. Tests for SAR are conducted using standard operating positions specified by the FCC with the phone transmitting at its highest certified power level in all tested frequency bands. Although SAR is determined at the highest certified power level, the actual SAR level of the phone while operating can be well below the maximum value. Because the phone is designed to operate at multiple power levels to use only the power required to reach the network, in general, the closer you are to a wireless base station antenna, the lower the power output. Before a phone model is available for sale to the public, it must be tested and certified to the FCC that it does not exceed the limit established by the government-adopted requirement for safe exposure. The tests are performed in positions and locations (e.g., at the ear and worn on the body) as required by the FCC for each model.

The highest SAR values are:

* Head: 1.11 W/kg

* Body (Body-worn/Hotspot): 0.99 W/kg

(Body measurements differ among phone models, depending upon available accessories and FCC requirements).

While there may be differences between SAR levels of various phones and at various positions, they all meet the government requirement for safe exposure.

The FCC has granted an Equipment Authorization for this model phone with all reported SAR levels evaluated as in compliance with the FCC RF emission guidelines. SAR information on this model phone is on file with the FCC and can be found under the Display Grant section of <http://www.fcc.gov/oet/fccid> after searching on FCC ID ZNFM150. Additional information on Specific Absorption Rates (SAR) can be found on the Cellular Telecommunications Industry Association (CTIA) website at <http://www.ctia.org/>.

* In the United States and Canada, the SAR limit for mobile phones used by the public is 1.6 watts/kg (W/kg) averaged over one gram of tissue. The standard incorporates a substantial margin of safety to give additional protection for the public and to account for any variations in measurements.

FCC Hearing-Aid Compatibility (HAC) Regulations for Wireless Devices

On July 10, 2003, the U.S. Federal Communications Commission (FCC) Report and Order in WT Docket 01-309 modified the exception of wireless phones under the Hearing Aid Compatibility Act of 1988 (HAC Act) to require digital wireless phones be compatible with hearingaids. The intent of the HAC Act is to ensure reasonable access to telecommunications services for persons with hearing disabilities. While some wireless phones are used near some hearing devices (hearing aids and cochlear implants), users may detect a buzzing, humming, or whining noise. Some hearing devices are more immune than others to this interference noise, and phones also vary in the amount of interference they generate.

The wireless telephone industry has developed a rating system for wireless phones, to assist hearing device users to find phones that may be compatible with their hearing devices. Not all phones have been rated. Phones that are rated have the rating on their box or a label located on the box.

The ratings are not guarantees. Results will vary depending on the user's hearing device and hearing loss. If your hearing device happens to be vulnerable to interference, you may not be able to use a rated phone successfully. Trying out the phone with your hearing device is the best way to evaluate it for your personal needs.

M-Ratings: Phones rated M3 or M4 meet FCC requirements and are likely to generate less interference to hearing devices than phones that are not labeled. M4 is the better/higher of the two ratings. T-Ratings: Phones rated T3 or T4 meet FCC requirements and are likely to generate less interference to hearing devices than phones that are not labeled. T4 is the better/ higher of the two ratings.

Hearing devices may also be rated. Your hearing device manufacturer or hearing health professional may help you find this rating. Higher ratings mean that the hearing device is relatively immune to interference noise. The hearing aid and wireless phone rating values are then added together.

A sum of 5 is considered acceptable for normal use. A sum of 6 is considered for best use.

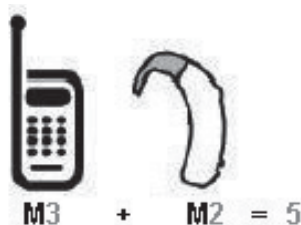

In the above example, if a hearing aid meets the M2 level rating and the wireless phone meets the M3 level rating, the sum of the two values equal M5. This should provide the hearing aid user with “normal usage” while using their hearing aid with the particular wireless phone. “Normal usage” in this context is defined as a signal quality that’s acceptable for normal operation.

The M mark is intended to be synonymous with the U mark. The T mark is intended to be synonymous with the UT mark. The M and T marks are recommended by the Alliance for Telecommunications Industries Solutions (ATIS). The U and UT marks are referenced in Section 20.19 of the FCC Rules. The HAC rating and measurement procedure are described in the American National Standards Institute (ANSI) C63.19 standard.

To ensure that the Hearing Aid Compatibility rating for your phone is maintained, secondary transmitters such as Bluetooth and WLAN components must be disabled during a call.

For information about hearing aids and digital wireless phones

Wireless Phones and Hearing Aid Accessibility

<http://www.accesswireless.org/>

Gallaudet University, RERC

<http://tap.gallaudet.edu/Voice/>

FCC Hearing Aid Compatibility and Volume Control

<https://www.fcc.gov/general/hearing-aid-compatibility-and-volume-control>

The Hearing Aid Compatibility FCC Order

http://hraunfoss.fcc.gov/edocs_public/attachmatch/FCC-03-168A1.pdf

Hearing Loss Association of America [HLAA]

<http://hearingloss.org/content/telephones-and-mobile-devices>

Caution:

Avoid potential hearing loss.

Prolonged exposure to loud sounds (including music) is the most common cause of preventable hearing loss. Some scientific research suggests that using portable audio devices, such as portable music players and cellular telephones, at high volume settings for long durations may lead to permanent noise-induced hearing loss. This includes the use of headphones (including headsets, earbuds and Bluetooth or other wireless devices). Exposure to very loud sound has also been associated in some studies with tinnitus (a ringing in the ear), hypersensitivity to sound and distorted hearing. Individual susceptibility to noise-induced hearing loss and other potential hearing problems varies.

The amount of sound produced by a portable audio device varies depending on the nature of the sound, the device, the device settings and the headphones. You should follow some commonsense recommendations when using any portable audio device:

- Set the volume in a quiet environment and select the lowest volume at which you can hear adequately.
- When using headphones, turn the volume down if you cannot hear the people speaking near you or if the person sitting next to you can hear what you are listening to.
- Do not turn the volume up to block out noisy surroundings. If you choose to listen to your portable device in a noisy environment, use noise-canceling headphones to block out background environmental noise.
- Limit the amount of time you listen. As the volume increases, less time is required before your hearing could be affected.
- Avoid using headphones after exposure to extremely loud noises, such as rock concerts, that might cause temporary hearing loss. Temporary hearing loss might cause unsafe volumes to sound normal.
- Do not listen at any volume that causes you discomfort. If you experience ringing in your ears, hear muffled speech or experience any temporary hearing difficulty after listening to your portable audio device, discontinue use and consult your doctor.

TIA Safety Information

The following is the complete TIA Safety Information for wireless handheld phones.

Exposure to Radio Frequency Signal

Your wireless handheld portable phone is a low power radio transmitter and receiver. When ON, it receives and sends out Radio Frequency (RF) signals.

In August, 1996, the Federal Communications Commissions (FCC) adopted RF exposure guidelines with safety levels for handheld wireless phones. Those guidelines are consistent with the safety standards previously set by both U.S. and international standards bodies:

ANSI C95.1 (1992) *

NCRP Report 86 (1986)

ICNIRP (1996)

* American National Standards Institute; National Council on Radiation Protection and Measurements; International Commission on Non-Ionizing Radiation Protection.

Those standards were based on comprehensive and periodic evaluations of the relevant scientific literature. For example, over 120 scientists, engineers, and physicians from universities, government health agencies, and industry reviewed the available body of research to develop the ANSI Standard (C95.1).

The design of your phone complies with the FCC guidelines (and those standards).

Tips on Efficient Operation

For your phone to operate most efficiently:

Don't touch the antenna unnecessarily when the phone is in use. Contact with the antenna affects call quality and may cause the phone to operate at a higher power level than otherwise needed.

Electronic Devices

Most modern electronic equipment is shielded from RF signals. However, certain electronic equipment may not be shielded against the RF signals from your wireless phone.

Pacemakers

The Health Industry Manufacturers Association recommends that a minimum separation of six (6) inches be maintained between a handheld wireless phone and a pacemaker to avoid potential interference with the pacemaker. These recommendations are consistent with the independent research by and recommendations of Wireless Technology Research.

Persons with pacemakers:

- Should ALWAYS keep the phone more than six (6) inches from their pacemaker when the phone is turned ON;
- Should not carry the phone in a breast pocket;
- Should use the ear opposite the pacemaker to minimize the potential for interference;
- Should turn the phone OFF immediately if there is any reason to suspect that interference is taking place.

Hearing Aids

Some digital wireless phones may interfere with some hearing aids. In the event of such interference, you may want to consult your service provider (or call the customer service line to discuss alternatives).

Other Medical Devices

If you use any other personal medical device, consult the manufacturer of your device to determine if it is adequately shielded from external RF energy. Your physician may be able to assist you in obtaining this information.

Health Care Facilities

Turn your phone OFF in health care facilities when any regulations posted in these areas instruct you to do so. Hospitals or health care facilities may use equipment that could be sensitive to external RF energy.

Vehicles

RF signals may affect improperly installed or inadequately shielded electronic systems in motor vehicles. Check with the manufacturer or its representative regarding your vehicle. You should also consult the manufacturer of any equipment that has been added to your vehicle.

Posted Facilities

Turn your phone OFF in any facility where posted notices so require.

Aircraft

FCC regulations prohibit using your phone while in the air. Switch OFF your phone before boarding an aircraft.

Blasting Areas

To avoid interfering with blasting operations, turn your phone OFF when in a “blasting area” or in areas posted: “Turn off two-way radio.” Obey all signs and instructions.

Potentially Explosive Atmosphere

Turn your phone OFF when in any area with a potentially explosive atmosphere and obey all signs and instructions. Sparks in such areas could cause an explosion or fire resulting in bodily injury or even death. Areas with a potentially explosive atmosphere are often, but not always marked clearly. Potential areas may include: fueling areas (such as gasoline stations); below deck on boats; fuel or chemical transfer or storage facilities; vehicles using liquefied petroleum gas (such as propane or butane); areas where the air contains chemicals or particles (such as grain, dust, or metal powders); and any other area where you would normally be advised to turn off your vehicle engine.

For Vehicles Equipped with an Air Bag

An air bag inflates with great force. DO NOT place objects, including either installed or portable wireless equipment, in the area over the air bag or in the air bag deployment area. If in-vehicle wireless equipment is improperly installed and the air bag inflates, serious injury could result.

Part 15.19 statement

This device complies with part 15 of the FCC rules. Operation is subject to the following two conditions:

- (1) This device may not cause harmful interference, and
- (2) This device must accept any interference received, including interference that may cause undesired operation.

Part 15.21 statement

Changes or modifications that are not expressly approved by the manufacturer for compliance could void the user's authority to operate the equipment.

Part 15.105 statement

This equipment has been tested and found to comply with the limits for a class B digital device, pursuant to Part 15 of the FCC rules. These limits are designed to provide reasonable protection against harmful interference in a residential installation. This equipment generates, uses, and can radiate radio frequency energy and, if not installed and used in accordance with the instructions, may cause harmful interference to radio communications. However, there is no guarantee that interference will not occur in a particular installation. If this equipment does cause harmful interference to radio or television reception, which can be determined by turning the equipment off and on, the user is encouraged to try to correct the interference by one or more of the following measures:

- Reorient or relocate the receiving antenna.
- Increase the separation between the equipment and receiver.
- Connect the equipment into an outlet on a circuit different from that to which the receiver is connected.
- Consult the dealer or an experienced radio/TV technician for help.

Safety Information

Please read and observe the following information for safe and proper use of your phone and to prevent damage.

Caution

Violation of the instructions may cause minor or serious damage to the product.

- Do not disassemble or open crush, bend or deform, puncture or shred.
- Do not modify or remanufacture, attempt to insert foreign objects into the battery, immerse or expose to water or other liquids, expose to fire, explosion or other hazard. Such conditions may present the risk of fire or explosion.
- Only use the battery for the system for which it is specified.
- Only use the battery with a charging system that has been qualified with the system per CTIA Certification Requirements for Battery System Compliance to IEEE1725. Use of an unqualified battery or charger may present a risk of fire, explosion, leakage, or other hazard.
- Do not short circuit a battery or allow metallic conductive objects to contact battery terminals.
- Replace the battery only with another battery that has been qualified with the system per this standard, IEEE-Std-1725. Use of an unqualified battery may present a risk of fire, explosion, leakage or other hazard. Only authorized service providers shall replace battery. (If the battery is nonuser replaceable)
- Promptly dispose of used batteries in accordance with local regulations.
- Battery usage by children should be supervised.
- Avoid dropping the phone or battery. If the phone or battery is dropped, especially on a hard surface, and the user suspects damage, take it to a service center for inspection.
- Improper battery use may result in a fire, explosion or other hazard.

Charger and Adapter Safety

- The charger and adapter are intended for indoor use only.
- Insert the battery charger vertically into the wall power socket.
- Only use the LG-approved battery charger. Otherwise, you may cause serious damage to your phone.
- Use the correct adapter for your phone when using the battery charger abroad.

Battery Information and Care

- Always unplug the charger from the wall socket after the phone is fully charged to save unnecessary power consumption of the charger.
- Please read the manual of specified charger about charging method.
- Do not damage the power cord by bending, twisting, or heating. Do not use the plug if it is loose as it may cause electric shock or fire.
- Do not place any heavy items on the power cord. Do not allow the power cord to be crimped as it may cause electric shock or fire.
- Unplug the power cord prior to cleaning your phone, and clean the power plug pin when it's dirty. When using the power plug, ensure that it's firmly connected. If not, it may cause excessive heat or fire. If you put your phone in a pocket or bag without covering the receptacle of the phone (power plug pin), metallic articles (such as a coin, paperclip or pen) may short-circuit the phone. Always cover the receptacle when not in use.
- Recharge the battery after long periods of non-use to maximize battery life. Battery life will vary due to usage pattern and environmental conditions.
- Please use only an approved charging accessory to charge your LG phone. Improper handling of the charging port, as well as the use of an incompatible charger, may cause damage to your phone and void the warranty.
- Charging temperature range is regulated between 0 °C/32 °F and 45 °C/113 °F. Do not charge the battery out of recommended temperature range. Charging out of recommended range might cause the generating heat or serious damage of battery. And also, it might cause the deterioration of battery's characteristics and cycle life.

- Do not use or leave the battery under the blazing sun or in heated car by sunshine. The battery may generate heat, smoke or flame. And also, it might cause the deterioration of battery's characteristics or cycle life.
- The battery pack has protection circuit to avoid the danger. Do not use nearby the place where generates static electricity more than 100V which gives damage to the protection circuit. If the protection circuit were broken, the battery would generate smoke, rupture or flame.
- If the skin or cloth is smeared with liquid from the battery, wash with fresh water. It may cause the skin inflammation.
- Please take your phone to an authorized service center immediately if this occurs.
- Do not handle the phone with wet hands while it is being charged. It may cause an electric shock or seriously damage your phone.
- Do not place or answer calls while charging the phone as it may short-circuit the phone and/or cause electric shock or fire.
- The charger and adapter are intended for indoor use only.
- Talking on your phone for a long period of time may reduce call quality due to heat generated during use.

Explosion, Shock, and Fire Hazards

- Do not put your phone in a place subject to excessive dust and keep the minimum required distance between the power cord and heat sources.
- Unplug the power cord prior to cleaning your phone, and clean the power plug pin when it's dirty.
- When using the power plug, ensure that it's firmly connected. If not, it may cause excessive heat or fire.
- If you put your phone in a pocket or bag without covering the receptacle of the phone (power plug pin), metallic articles (such as a coin, paperclip or pen) may short-circuit the phone and may cause an explosion. Always cover the receptacle when not in use.

General Notice

- Do not place items containing magnetic components such as a credit card, phone card, bank book, or subway ticket near your phone. The magnetism of the phone may damage the data stored in the magnetic strip.
- Talking on your phone for a long period of time may reduce call quality due to heat generated during use.
- When the phone is not used for a long period time, store it in a safe place with the power cord unplugged.
- Using the phone in proximity to receiving equipment (i.e., TV or radio) may cause interference to the phone.
- Do not immerse your phone in water, liquid, or expose to high humidity. Immediately, take it to an LG Authorized Service Center.
- Do not paint your phone.
- The data saved in your phone might be deleted due to careless use, repair of the phone, or upgrade of the software. Please backup your important phone numbers. (Ringtones, text messages, voice messages, pictures, and videos could also be deleted.) The manufacturer is not liable for damage due to the loss of data.
- When you use the phone in public places, set the ringtone to vibration so you don't disturb others.
- Do not turn your phone on or off when putting it to your ear.
- Use accessories, such as earphones and headsets, with caution. Ensure that cables are tucked away safely and do not touch the antenna unnecessarily.

FDA Consumer Update



The U.S. Food and Drug Administration's Center for Devices and Radiological Health Consumer Update on Mobile Phones:

1. Do wireless phones pose a health hazard?

The available scientific evidence does not show that any health problems are associated with using wireless phones. There is no proof, however, that wireless phones are absolutely safe. Wireless phones emit low levels of Radio Frequency (RF) energy in the microwave range while being used. They also emit very low levels of RF when in standby mode. Whereas high levels of RF can produce health effects (by heating tissue), exposure to low level RF that does not produce heating effects causes no known adverse health effects. Many studies of low level RF exposures have not found any biological effects. Some studies have suggested that some biological effects may occur, but such findings have not been confirmed by additional research. In some cases, other researchers have had difficulty in reproducing those studies, or in determining the reasons for inconsistent results.

2. What is the FDA's role concerning the safety of wireless phones?

Under the law, the FDA does not review the safety of radiation-emitting consumer products such as wireless phones before they can be sold, as it does with new drugs or medical devices. However, the agency has authority to take action if wireless phones are shown to emit Radio Frequency (RF) energy at a level that is hazardous to the user. In such a case, the FDA could require the manufacturers of wireless phones to notify users of the health hazard and to repair, replace, or recall the phones so that the hazard no longer exists. Although the existing scientific data do not justify FDA regulatory actions, the FDA has urged the wireless phone industry to take a number of steps, including the following:

- Support needed research into possible biological effects of RF of the type emitted by wireless phones;
- Design wireless phones in a way that minimizes any RF exposure to the user that is not necessary for device function; and

- Cooperate in providing users of wireless phones with the best possible information on possible effects of wireless phone use on human health.

The FDA belongs to an interagency working group of the federal agencies that have responsibility for different aspects of RF safety to ensure coordinated efforts at the federal level. The following agencies belong to this working group:

- National Institute for Occupational Safety and Health
- Environmental Protection Agency
- Occupational Safety and Health Administration
- National Telecommunications and Information Administration

The National Institutes of Health participates in some interagency working group activities, as well.

The FDA shares regulatory responsibilities for wireless phones with the Federal Communications Commission (FCC). All phones that are sold in the United States must comply with FCC safety guidelines that limit RF exposure. The FCC relies on the FDA and other health agencies for safety questions about wireless phones.

The FCC also regulates the base stations that the wireless phone networks rely upon. While these base stations operate at higher power than do the wireless phones themselves, the RF exposures that people get from these base stations are typically thousands of times lower than those they can get from wireless phones. Base stations are thus not the subject of the safety questions discussed in this document.

3. What kinds of phones are the subject of this update?

The term “wireless phone” refers here to handheld wireless phones with built-in antennas, often called “cell”, “mobile”, or “PCS” phones. These types of wireless phones can expose the user to measurable Radio Frequency (RF) energy because of the short distance between the phone and the user’s head.

These RF exposures are limited by FCC safety guidelines that were developed with the advice of the FDA and other federal health and safety agencies.

When the phone is located at greater distances from the user, the exposure to RF is drastically lower because a person’s RF exposure decreases rapidly with increasing distance from the source. The so-called “cordless phones,” which have a base unit connected to the telephone wiring in a house, typically operate at far lower power levels, and thus produce RF exposures far below the FCC safety limits.

4. What are the results of the research done already?

The research done thus far has produced conflicting results, and many studies have suffered from flaws in their research methods. Animal experiments investigating the effects of Radio Frequency (RF) energy exposures characteristic of wireless phones have yielded conflicting results that often cannot be repeated in other laboratories. A few animal studies, however, have suggested that low levels of RF could accelerate the development of cancer in laboratory animals. However, many of the studies that showed increased tumor development used animals that had been genetically engineered or treated with cancer-causing chemicals so as to be pre-disposed to develop cancer in the absence of RF exposure. Other studies exposed the animals to RF for up to 22 hours per day. These conditions are not similar to the conditions under which people use wireless phones, so we do not know with certainty what the results of such studies mean for human health. Three large epidemiology studies have been published since December 2000. Between them, the studies investigated any possible association between the use of wireless phones and primary brain cancer, glioma, meningioma, or acoustic neuroma, tumors of the brain or salivary gland, leukemia, or other cancers. None of the studies demonstrated the existence of any harmful health effects from wireless phone RF exposures. However, none of the studies can answer questions about long-term exposures, since the average period of phone use in these studies was around three years.

5. What research is needed to decide whether RF exposure from wireless phones poses a health risk?

A combination of laboratory studies and epidemiological studies of people actually using wireless phones would provide some of the data that are needed. Lifetime animal exposure studies could be completed in a few years. However, very large numbers of animals would be needed to provide reliable proof of a cancer promoting effect if one exists. Epidemiological studies can provide data that is directly applicable to human populations, but ten or more years follow-up may be needed to provide answers about some health effects, such as cancer. This is because the interval between the time of exposure to a cancer-causing agent and the time tumors develop – if they do – may be many, many years. The interpretation of epidemiological studies is hampered by difficulties in measuring actual RF exposure during day-to-day use of wireless phones. Many factors affect this measurement, such as the angle at which the phone is held, or which model of phone is used.

6. What is the FDA doing to find out more about the possible health effects of wireless phone RF?

The FDA is working with the U.S. National Toxicology Program and with groups of investigators around the world to ensure that high priority animal studies are conducted to address important questions about the effects of exposure to Radio Frequency (RF) energy.

The FDA has been a leading participant in the World Health Organization International Electro Magnetic Fields (EMF) Project since its inception in 1996. An influential result of this work has been the development of a detailed agenda of research needs that has driven the establishment of new research programs around the world. The project has also helped develop a series of public information documents on EMF issues. The FDA and the Cellular Telecommunications & Internet Association (CTIA) have a formal Cooperative Research And Development Agreement (CRADA) to do research on wireless phone safety. The FDA provides the scientific oversight, obtaining input from experts in government, industry, and academic organizations. CTIA-funded research is conducted through contracts with independent investigators. The initial research will include both laboratory studies and studies of wireless phone users. The CRADA will also include a broad assessment of additional research needs in the context of the latest research developments around the world.

7. How can I find out how much Radio Frequency energy exposure I can get by using my wireless phone?

All phones sold in the United States must comply with Federal Communications Commission (FCC) guidelines that limit Radio Frequency (RF) energy exposures. The FCC established these guidelines in consultation with the FDA and the other federal health and safety agencies. The FCC limit for RF exposure from wireless phones is set at a Specific Absorption Rate (SAR) of 1.6 watts per kilogram (1.6 W/kg). The FCC limit is consistent with the safety standards developed by the Institute of Electrical and Electronic Engineering (IEEE) and the National Council on Radiation Protection and Measurement. The exposure limit takes into consideration the body's ability to remove heat from the tissues that absorb energy from the wireless phone and is set well below levels known to have effects. Manufacturers of wireless phones must report the RF exposure level for each model of phone to the FCC. The FCC website (<http://www.fcc.gov/oet/rfsafety>) gives directions for locating the FCC identification number on your phone so you can find your phone's RF exposure level in the online listing.

8. What has the FDA done to measure the Radio Frequency energy coming from wireless phones?

The Institute of Electrical and Electronic Engineers (IEEE) is developing a technical standard for measuring the Radio Frequency (RF) energy exposure from wireless phones and other wireless handsets with the participation and leadership of FDA scientists and engineers. The standard, "Recommended Practice for Determining the Spatial-Peak Specific Absorption Rate (SAR) in the Human Body Due to Wireless Communications Devices: Experimental Techniques", sets forth the first consistent test methodology for measuring the rate at which RF is deposited in the heads of wireless phone users. The test method uses a tissue-simulating model of the human head.

Standardized SAR test methodology is expected to greatly improve the consistency of measurements made at different laboratories on the same phone. SAR is the measurement of the amount of energy absorbed in tissue, either by the whole body or a small part of the body. It is measured in watts/kg (or milliwatts/g) of matter. This measurement is used to determine whether a wireless phone complies with safety guidelines.

9. What steps can I take to reduce my exposure to Radio Frequency energy from my wireless phone?

If there is a risk from these products — and at this point we do not know that there is — it is probably very small. But if you are concerned about avoiding even potential risks, you can take a few simple steps to minimize your exposure to Radio Frequency (RF) energy. Since time is a key factor in how much exposure a person receives, reducing the amount of time spent using a wireless phone will reduce RF exposure. If you must conduct extended conversations by wireless phone every day, you could place more distance between your body and the source of the RF, since the exposure level drops off dramatically with distance. For example, you could use a headset and carry the wireless phone away from your body or use a wireless phone connected to a remote antenna. Again, the scientific data does not demonstrate that wireless phones are harmful. But if you are concerned about the RF exposure from these products, you can use measures like those described above to reduce your RF exposure from wireless phone use.

10. What about children using wireless phones?

The scientific evidence does not show a danger to users of wireless phones, including children and teenagers. If you want to take steps to lower exposure to Radio Frequency (RF) energy, the measures described above would apply to children and teenagers using wireless phones. Reducing the time of wireless phone use and increasing the distance between the user and the RF source will reduce RF exposure. Some groups sponsored by other national governments have advised that children be discouraged from using wireless phones at all. For example, the government in the United Kingdom distributed leaflets containing such a recommendation in December 2000.

They noted that no evidence exists that using a wireless phone causes brain tumors or other ill effects. Their recommendation to limit wireless phone use by children was strictly precautionary; it was not based on scientific evidence that any health hazard exists.

11. What about wireless phone interference with medical equipment?

Radio Frequency (RF) energy from wireless phones can interact with some electronic devices. For this reason, the FDA helped develop a detailed test method to measure Electro Magnetic Interference (EMI) of implanted cardiac pacemakers and defibrillators from wireless telephones. This test method is now part of a standard sponsored by the Association for the Advancement of Medical Instrumentation (AAMI). The final draft, a joint effort by the FDA, medical device manufacturers, and many other groups, was completed in late 2000. This standard will allow manufacturers to ensure that cardiac pacemakers and defibrillators are safe from wireless phone EMI.

The FDA has tested hearing aids for interference from handheld wireless phones and helped develop a voluntary standard sponsored by the Institute of Electrical and Electronic Engineers (IEEE). This standard specifies test methods and performance requirements for hearing aids and wireless phones so that no interference occurs when a person uses a "compatible" phone and a "compatible" hearing aid at the same time. This standard was approved by the IEEE in 2000.

The FDA continues to monitor the use of wireless phones for possible interactions with other medical devices. Should harmful interference be found to occur, the FDA will conduct testing to assess the interference and work to resolve the problem.

12. Where can I find additional information?

For additional information, please refer to the following resources:

FDA web page on wireless phones

(<http://www.fda.gov/Radiation-EmittingProducts/RadiationEmittingProductsandProcedures/HomeBusinessandEntertainment/CellPhones/default.htm>)

Federal Communications Commission (FCC) RF Safety Program

(<http://www.fcc.gov/oet/rfsafety>)

International Commission on Non-Ionizing Radiation Protection

(<http://www.icnirp.de>)

World Health Organization (WHO) International EMF Project

(<http://www.who.int/emf>)

National Radiological Protection Board (UK)

(<http://www.hpa.org.uk/radiation/>)

Driving

Check the laws and regulations on the use of wireless phones in the areas where you drive and always obey them. Also, if using your phone while driving, please observe the following:

- Give full attention to driving -- driving safely is your first responsibility;
- Use hands-free operation, if available;
- Pull off the road and park before making or answering a call if driving conditions or the law require it.

10 Driver Safety Tips

Your wireless phone gives you the powerful ability to communicate by voice almost anywhere, anytime. An important responsibility accompanies the benefits of wireless phones, one that every user must uphold. When operating a car, driving is your first responsibility. When using your wireless phone behind the wheel of a car, practice good common sense and remember the following tips:

1. Get to know your wireless phone and its features such as speed dial and redial. Carefully read your instruction manual and learn to take advantage of valuable features most phones offer, including automatic redial and memory. Also, work to memorize the phone keypad so you can use the speed dial function without taking your attention off the road.
2. When available, use a hands-free device. A number of hands-free wireless phone accessories are readily available today. Whether you choose an installed mounted device for your wireless phone or a speaker phone accessory, take advantage of these devices if available to you.
3. Make sure you place your wireless phone within easy reach and where you can reach it without removing your eyes from the road. If you get an incoming call at an inconvenient time, if possible, let your voicemail answer it for you.
4. Suspend conversations during hazardous driving conditions or situations. Let the person you are speaking with know you are driving; if necessary, suspend the call in heavy traffic or hazardous weather conditions. Rain, sleet, snow, and ice can be hazardous, but so is heavy traffic. As a driver, your first responsibility is to pay attention to the road.
5. Don't take notes or look up phone numbers while driving. If you are reading an address book or business card, or writing a "to-do" list while driving a car, you are not watching where you are going. It is common sense. Do not get caught in a dangerous situation because you are reading or writing and not paying attention to the road or nearby vehicles.
6. Dial sensibly and assess the traffic; if possible, place calls when you are not moving or before pulling into traffic. Try to plan your calls before you begin your trip or attempt to coincide your calls with times you may be stopped at a stop sign, red light, or otherwise stationary. But if you need to dial while driving, follow this simple tip -- dial only a few numbers, check the road and your mirrors, then continue.

7. Do not engage in stressful or emotional conversations that may be distracting. Stressful or emotional conversations and driving do not mix; they are distracting and even dangerous when you are behind the wheel of a car. Make people you are talking with aware you are driving and if necessary, suspend conversations which have the potential to divert your attention from the road.
8. Use your wireless phone to call for help. Your wireless phone is one of the greatest tools you can own to protect yourself and your family in dangerous situations -- with your phone at your side, help is only three numbers away. Dial 911 or other local emergency number in the case of fire, traffic accident, road hazard, or medical emergency. Remember, it's a free call on your wireless phone!
9. Use your wireless phone to help others in emergencies. Your wireless phone provides you a perfect opportunity to be a "Good Samaritan" in your community. If you see an auto accident, crime in progress or other serious emergency where lives are in danger, call 911 or other local emergency number, as you would want others to do for you.
10. Call roadside assistance or a special wireless non-emergency assistance number when necessary. Certain situations you encounter while driving may require attention, but are not urgent enough to merit a call for emergency services. But you can still use your wireless phone to lend a hand. If you see a broken-down vehicle posing no serious hazard, a broken traffic signal, a minor traffic accident where no one appears injured or a vehicle you know to be stolen, call roadside assistance or other special non-emergency wireless number.

The above tips are meant as general guidelines. Before deciding to use your mobile device while operating a vehicle, it is recommended that you consult your applicable jurisdiction's local laws or other regulations regarding such use. Such laws or other regulations may prohibit or otherwise restrict the manner in which a driver may use his or her phone while operating a vehicle.



**LIMITED
WARRANTY
STATEMENT**

ARBITRATION NOTICE: THIS LIMITED WARRANTY CONTAINS AN ARBITRATION PROVISION THAT REQUIRES YOU AND LG TO RESOLVE DISPUTES BY BINDING ARBITRATION INSTEAD OF IN COURT, UNLESS YOU CHOOSE TO OPT OUT. IN ARBITRATION, CLASS ACTIONS AND JURY TRIALS ARE NOT PERMITTED. PLEASE SEE THE SECTION TITLED “PROCEDURE FOR RESOLVING DISPUTES” BELOW.

Warranty Laws

The following laws govern warranties that arise in retail sales of consumer goods:

- The California Song-Beverly Consumer Warranty Act [CC §§1790 et seq],
- The California Uniform Commercial Code, Division Two [Com C §§2101 et seq], and
- The federal Magnuson-Moss Warranty Federal Trade Commission Improvement Act [15 USC §§2301 et seq; 16 CFR Parts 701 – 703].
A typical Magnuson-Moss Act warranty is a written promise that the product is free of defects or a written promise to refund, repair, or replace defective goods. [See 15 USC §2301(6).] Remedies include damages for failing to honor a written warranty or service contract or for violating disclosure provisions. [See 15 USC §2310(d).] Except for some labeling and disclosure requirements, the federal Act does not preempt state law. [See 15 USC §2311.]

1. WHAT THIS WARRANTY COVERS:

LG offers you a limited warranty that the enclosed subscriber unit and its enclosed accessories will be free from defects in material and workmanship, according to the following terms and conditions:

(1) The limited warranty for the product extends for TWELVE (12) MONTHS beginning on the date of purchase of the product with valid proof of purchase, or absent valid proof of purchase, FIFTEEN (15) MONTHS from date of manufacture as determined by the unit’s manufacture date code.

(2) The limited warranty extends only to the original purchaser of the product and is not assignable or transferable to any subsequent purchaser/end user.

(3) This warranty is good only to the original purchaser of the product during the warranty period as long as it is in the U.S., including Alaska, Hawaii, U.S. Territories and Canada.

(4) The external housing and cosmetic parts shall be free of defects at the time of shipment and, therefore, shall not be covered under these limited warranty terms.

(5) Upon request from LG, the consumer must provide information to reasonably prove the date of purchase.

(6) The customer shall bear the cost of shipping the product to the Customer Service Department of LG. LG shall bear the cost of shipping the product back to the consumer after the completion of service under this limited warranty.

2. WHAT THIS WARRANTY DOES NOT COVER:

(1) Defects or damages resulting from use of the product in other than its normal and customary manner.

(2) Defects or damages from abnormal use, abnormal conditions, improper storage, exposure to moisture or dampness, unauthorized modifications, unauthorized connections, unauthorized repair, misuse, neglect, abuse, accident, alteration, improper installation, or other acts which are not the fault of LG, including damage caused by shipping, blown fuses, spills of food or liquid.

(3) Breakage or damage to antennas unless caused directly by defects in material or workmanship.

(4) That the Customer Service Department at LG was not notified by consumer of the alleged defect or malfunction of the product during the applicable limited warranty period.

(5) Products which have had the serial number removed or made illegible.

(6) This limited warranty is in lieu of all other warranties, express or implied either in fact or by operations of law, statutory or otherwise, including, but not limited to any implied warranty of marketability or fitness for a particular use.

(7) Damage resulting from use of non LG approved accessories.

(8) All plastic surfaces and all other externally exposed parts that are scratched or damaged due to normal customer use.

(9) Products operated outside published maximum ratings.

(10) Products used or obtained in a rental program.

(11) Consumables (such as fuses).

3. WHAT LG WILL DO:

LG will, at its sole option, either repair, replace or refund the purchase price of any unit that is covered under this limited warranty. LG may choose at its option to use functionally equivalent re-conditioned, refurbished or new units or parts or any units. In addition, LG will not re-install or back-up any data, applications or software that you have added to your phone. It is therefore recommended that you back-up any such data or information prior to sending the unit to LG to avoid the permanent loss of such information.

4. STATE LAW RIGHTS:

No other express warranty is applicable to this product. THE DURATION OF ANY IMPLIED WARRANTIES, INCLUDING THE IMPLIED WARRANTY OF MARKETABILITY OR MERCHANTABILITY OR FITNESS FOR A PARTICULAR PURPOSE, IS LIMITED TO THE DURATION OF THE EXPRESS WARRANTY HEREIN. LG SHALL NOT BE LIABLE FOR THE LOSS OF THE USE OF THE PRODUCT, INCONVENIENCE, LOSS OR ANY OTHER DAMAGES, DIRECT OR CONSEQUENTIAL, ARISING OUT OF THE USE OF, OR INABILITY TO USE, THIS PRODUCT OR FOR ANY BREACH OF ANY EXPRESS OR IMPLIED WARRANTY, INCLUDING THE IMPLIED WARRANTY OF MARKETABILITY OR MERCHANTABILITY OR FITNESS FOR A PARTICULAR PURPOSE APPLICABLE TO THIS PRODUCT.

Some states do not allow the exclusive limitation of incidental or consequential damages or limitations on how long an implied warranty lasts; so these limitations or exclusions may not apply to you. This warranty gives you specific legal rights and you may also have other rights which vary from state to state.

5. HOW TO GET WARRANTY SERVICE:

To obtain warranty service, please call or fax to the following telephone numbers from anywhere in the continental United States:

Tel. 1-800-793-8896 or Fax. 1-800-448-4026

Or visit <http://www.lg.com/us/support>. Correspondence may also be mailed to:

LG Electronics Service- Mobile Handsets, P.O. Box 240007, Huntsville, AL 35824

DO NOT RETURN YOUR PRODUCT TO THE ABOVE ADDRESS. Please call or write for the location of the LG authorized service center nearest you and for the procedures for obtaining warranty claims.

PROCEDURE FOR RESOLVING DISPUTES:

ALL DISPUTES BETWEEN YOU AND LG ARISING OUT OF OR RELATING IN ANY WAY TO THIS LIMITED WARRANTY OR THE PRODUCT SHALL BE RESOLVED EXCLUSIVELY THROUGH BINDING ARBITRATION, AND NOT IN A COURT OF GENERAL JURISDICTION. BINDING ARBITRATION MEANS THAT YOU AND LG ARE EACH WAIVING THE RIGHT TO A JURY TRIAL AND TO BRING OR PARTICIPATE IN A CLASS ACTION.

Definitions. For the purposes of this section, references to “LG” mean LG Electronics MobileComm U.S.A., Inc., its parents, subsidiaries and affiliates, and each of their officers, directors, employees, agents, beneficiaries, predecessors in interest, successors, assigns and suppliers; references to “dispute” or “claim” shall include any dispute, claim or controversy of any kind whatsoever (whether based in contract, tort, statute, regulation, ordinance, fraud, misrepresentation or any other legal or equitable theory) arising out of or relating in any way to the sale, condition or performance of the product or this Limited Warranty.

Agreement to Binding Arbitration and Class Action Waiver. You and LG agree to resolve any claims between us only by binding arbitration on an individual basis, unless you opt out as provided below. Any dispute between you and LG shall not be combined or consolidated with a dispute involving any other person’s or entity’s product or claim. More specifically, without limitation of the foregoing, any dispute between you and LG shall not under any circumstances proceed as part of a class or representative action. Instead of arbitration, either party may bring an individual action in small claims court, but that small claims court action may not be brought on a class or representative basis.

Arbitration Rules and Procedures. To begin arbitration of a claim, either you or LG must make a written demand for arbitration. The arbitration will be administered by the American Arbitration Association (AAA) and will be conducted before a single arbitrator under the AAA’s Consumer Arbitration Rules that are in effect at the time the arbitration is initiated (referred to as the “AAA Rules”) and under the procedures set forth in this section. The AAA Rules are available online at www.adr.org/consumer. Send a copy of your written demand for arbitration, as well as a copy of this provision, to the AAA in the manner described in the AAA Rules. You must also send a copy of your written demand to LG at LG Electronics, USA, Inc. Attn: Legal Department-Arbitration 1000 Sylvan Avenue Englewood Cliffs, NJ 07632. If there is a conflict between the AAA Rules and the rules set forth in this section, the rules set forth in this section will govern. This arbitration provision is governed

by the Federal Arbitration Act. Judgment may be entered on the arbitrator's award in any court of competent jurisdiction. All issues are for the arbitrator to decide, except that issues relating to the scope and enforceability of the arbitration provision and to the arbitrability of the dispute are for the court to decide. The arbitrator is bound by the terms of this provision.

Governing Law: The law of the state of your residence shall govern this Limited Warranty and any disputes between us except to the extent that such law is preempted by or inconsistent with applicable federal law.

Fees/Costs. You do not need to pay any fee to begin an arbitration. Upon receipt of your written demand for arbitration, LG will promptly pay all arbitration filing fees to the AAA unless you seek more than \$25,000 in damages, in which case the payment of these fees will be governed by the AAA Rules. Except as otherwise provided for herein, LG will pay all AAA filing, administration and arbitrator fees for any arbitration initiated in accordance with the AAA Rules and this arbitration provision. If you prevail in the arbitration, LG will pay your reasonable attorneys' fees and expenses to the extent required by applicable law. If the arbitrator finds either the substance of your claim or the relief sought in the demand is frivolous or brought for an improper purpose (as measured by the standards set forth in Federal Rule of Civil Procedure 11(b)), then the payment of all arbitration fees will be governed by the AAA Rules. In such a situation, you agree to reimburse LG for all monies previously disbursed by it that are otherwise your obligation to pay under the AAA Rules.

Except as otherwise provided for, LG waives any rights it may have to seek attorneys' fees and expenses from you if LG prevails in the arbitration.

Hearings and Location. If your claim is for \$25,000 or less, you may choose to have the arbitration conducted solely on the basis of (1) documents submitted to the arbitrator, (2) through a telephonic hearing, or (3) by an in-person hearing as established by the AAA Rules. If your claim exceeds \$25,000, the right to a hearing will be determined by the AAA Rules. Any in-person arbitration hearings will be held at a location within the federal judicial district in which you reside unless we both agree to another location or we agree to a telephonic arbitration.

Opt Out. You may opt out of this dispute resolution procedure. If you opt out, neither you nor LG can require the other to participate in an arbitration proceeding. To opt out, you must send notice to LG no later than 30 calendar days from the date of the first consumer purchaser's purchase of the product by either: (i) sending an e-mail to optout@lge.com, with the subject line:

“Arbitration Opt Out” or (ii) calling 1-800-980-2973. You must include in the opt out e-mail or provide by telephone: (a) your name and address; (b) the date on which the product was purchased; (c) the product model name or model number, and (d) the IMEI or MEID or Serial Number, as applicable (the IMEI or MEID or Serial Number can be found (i) on the product box; (ii) on a label on the back of the product beneath the battery, if the battery is removable; or (iii) from the settings menu via the following path: **Settings > General > About phone > Status**).

You may only opt out of the dispute resolution procedure in the manner described above (that is, by e-mail or telephone); no other form of notice will be effective to opt out of this dispute resolution procedure. Opting out of this dispute resolution procedure will not affect the coverage of the Limited Warranty in any way, and you will continue to enjoy the full benefits of the Limited Warranty. If you keep this product and do not opt out, then you accept all terms and conditions of the arbitration provision described above.

