



ENGLISH

USER GUIDE

LG G Pad[®] X2
8.0 PLUS

LG-V530KB

Copyright ©2017 LG Electronics, Inc. All Rights Reserved.



MFL69657601 (1.0)

www.lg.com

About This User Guide

Thank you for choosing LG. Please carefully read this user guide before using the device for the first time to ensure safe and proper use.

- Always use genuine LG accessories. The supplied items are designed only for this device and may not be compatible with other devices.
- This device is not suitable for people who have a visual impairment due to the touchscreen keyboard.
- Descriptions are based on the device default settings.
- Default apps on the device are subject to updates and support for these apps may be withdrawn without prior notice. If you have any questions about an app provided with the device, please contact a LG Service center. For user-installed apps, please contact the relevant service provider.
- Modifying the device's operating system or installing software from unofficial sources may damage the device and lead to data corruption or data loss. Such actions will violate your LG license agreement and void your warranty.
- Some contents and illustrations may differ from your device depending on the region, service provider, software version, or OS version, and are subject to change without prior notice.
- Software, audio, wallpaper, images, and other media supplied with your device are licensed for limited use. If you extract and use these materials for commercial or other purposes, you may be infringing copyright laws. As a user, you are fully and entirely responsible for the illegal use of media.
- Additional charges may apply for data services, such as messaging, uploading, downloading, auto-syncing and location services. To avoid additional charges, select a data plan suitable to your needs. Contact your service provider to obtain additional details.

Instructional Notices



WARNING: Situations that could cause injury to the user and third parties.



CAUTION: Situations that may cause minor injury or damage to the device.



NOTE: Notices or additional information.

Table of Contents

01

Custom-designed Features

- 6 Comfort View
- 7 Gesture Shot
- 8 KnockON
- 9 Knock Code
- 10 Multi-tasking Feature
- 11 Capture+
- 12 QSlide

02

Basic Functions

- 14 Product components and accessories
- 15 Device Overview
- 18 Plus Pack Overview
- 20 Attaching the Tablet to the Plus Pack
- 21 Adjusting the Stand for Typing
- 22 Detaching the Tablet from the Plus Pack
- 22 Charging the Battery
- 25 Connecting a USB Device to Your Tablet
- 26 Installing the SIM Card or microSD Card
- 28 Removing the Memory Card
- 29 Touch Screen
- 32 Home Screen
- 38 Locking and Unlocking the Device
- 40 On-screen Keyboard
- 41 Connecting to Networks and Devices
- 47 Google Account Setup
- 48 Installing and uninstalling apps
- 49 App trash

03

Useful Apps

51	Contacts
53	Messaging
54	Email
56	Camera and Video
65	Music
66	LG SmartWorld
67	Clock
68	Calculator
68	Calendar
69	Tasks
69	Audio Recorder
70	File Manager
71	Downloads
71	LG Mobile Switch
71	Google Apps

04

Settings

74	Settings
75	WIRELESS NETWORKS
77	DEVICE
82	PERSONAL
85	SYSTEM

05

Appendix

89	LG Language Settings
89	Software Update
90	FAQ
91	Anti-Theft Guide
92	More Information

06

For Your Safety

07

LIMITED WARRANTY STATEMENT



Custom-designed Features

Comfort View

This feature reduces the amount of blue light on the screen to reduce eye strain.



Turning the Comfort View On/Off

- Slide the Status bar downward, tap , then tap  / .

OR

- Tap  >  > **Display** > **Comfort view**, and then tap  / .

Adjust the Blue Light Filter

- 1 Tap  >  > **Display** > **Comfort view**.
- 2 Select the desired blue light filter setting.

Gesture Shot

The Gesture shot feature allows you to take a picture with a hand gesture using the front camera.

To Take a Photo

There are two methods for using the Gesture shot feature.

- Raise your hand, with an open palm, until the front camera detects it and a box appears on the screen. Then close your hand into a fist to start the timer, allowing you time to get ready.

OR

- Raise your hand, in a clenched fist, until the front camera detects it and a box appears on the screen. Then unclench your fist to start the timer, allowing you time to get ready.

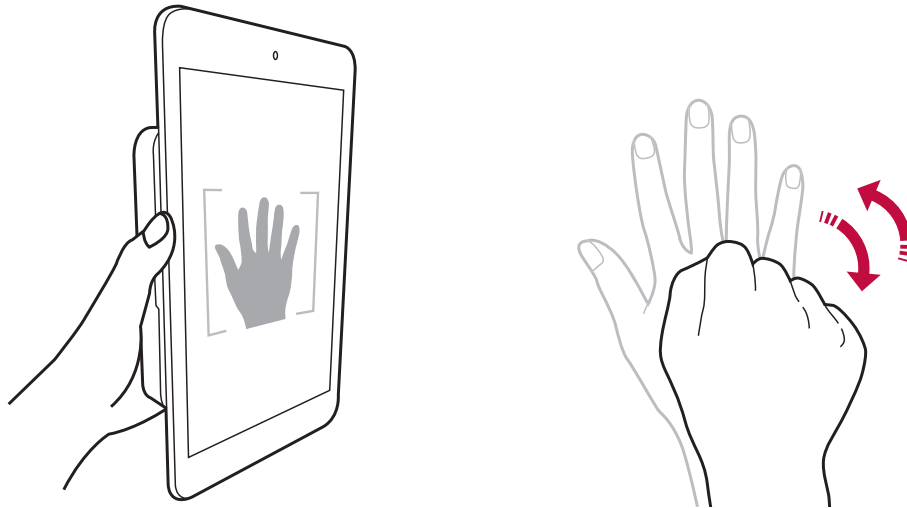

KnockON

The KnockON feature allows you to double-tap the screen to easily turn it on or off.

Turning the Screen On

While the screen is off, quickly double-tap the center of the screen to turn on the backlight and display the Lock screen.

Turning the Screen Off

Quickly double-tap the Status bar, an empty area on the Home screen, or the Lock screen to turn the screen off.



- Tap on the center area of the screen. If you tap on the bottom or the top area, the recognition rate may decrease.



Knock Code

The Knock Code feature allows you to create your own unlock code using a combination of knocks on the screen. You can access the Home screen directly when the screen is off by tapping the same sequence on the screen.



- You can use your Knock Code together with the KnockOn feature.
- Make sure to use your fingertip when tapping the screen.

Setting Up the Knock Code Feature

- 1 Tap  >  > **Display** > **Lock screen** > **Select screen lock** > **Knock Code**.
- 2 Tap the squares in a pattern to set your Knock Code. Your Knock Code pattern can be 6 to 10 taps.

Unlocking the Acreen Using the Knock Code

When the screen is off, you can unlock it by tapping the Knock Code pattern you've previously set.

Multi-tasking Feature

Multi-window

You can use two apps at the same time by separating the screen into multiple windows.

While using an app, touch and hold  from the Home touch buttons, then select an app from the recently-used apps list.

- You can use two apps at the same time.
- To stop the Multi-Window feature, touch and hold .

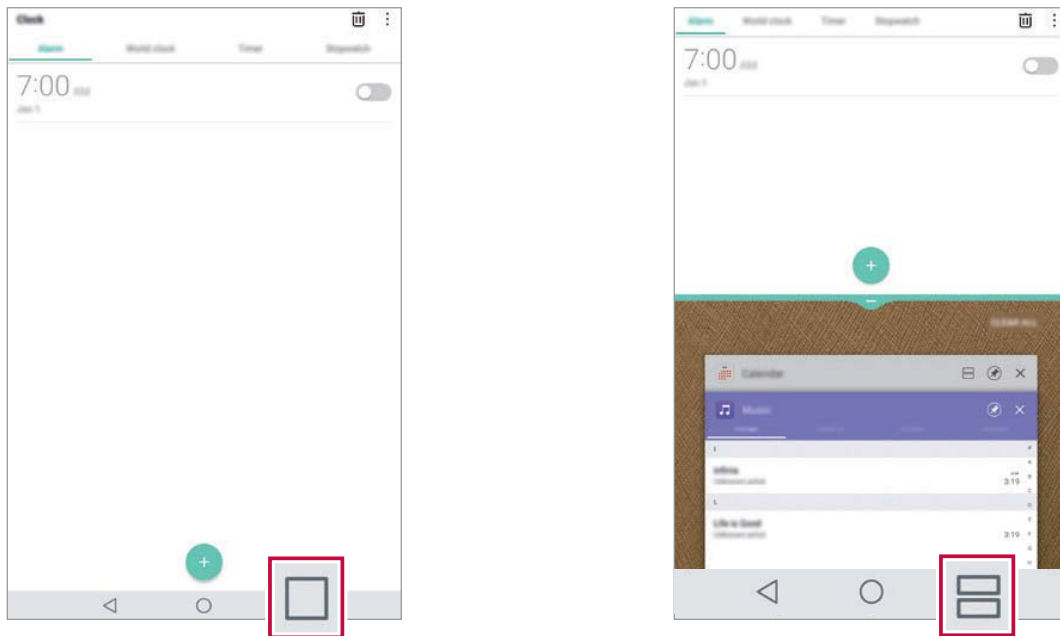

- The Multi-Window feature is not supported by some apps, including downloaded apps.

Overview Screen

The Overview screen provides a preview of your recently-used apps.

To view the list of recently-used apps, tap  on the Home touch buttons.

- Touch and hold an app and drag it to the top of the screen to start the app with the Multi-Window feature. You can also tap  at the top of each app preview.









Capture+

The Capture+ feature allows you to create memos.

Using Capture+

You can use Capture+ function to easily and efficiently create memos with a saved picture or on the current device screen.

- 1 Slide the Status bar downward and tap .
- 2 Create a memo using the following options:

	Tap to save the memo you've created.
	Tap to undo the most recent action.
	Tap to redo the most recently deleted action.
	Tap to insert text into your memo.
	Tap to select the pen type and color.
	Tap to crop the image of memo.
	Tap to share the memo or change the background paper style.
	Tap to hide or display the toolbar.



- Please use a fingertip while using the Capture+ feature. Do not use your fingernail.

- 3 Tap  to save the current memo to the **QuickMemo+** or the **Gallery**.

Viewing the Saved Memo

Tap  >  and select the **Capture+** album.

OR





Tap  >  and select the desired memo.

QSlide

You can display several apps simultaneously on the same screen and freely switch between them.

Using QSlide

- 1 When an app is running, tap  > **QSlide**.
- 2 The app switches to the QSlide mode. The following options are available.

	Switch to full-screen mode.
	Adjust the opacity of the QSlide window. If the window is transparent, you can interact with the background.
	Close the QSlide window.
	Adjust the size of the QSlide window.



- QSlide can support up to two windows at the same time.
- This feature may not be supported by some apps.



Basic Functions

Product components and accessories

The following items are included with your device.

- Device
- USB cable
- Charger
- QSG
- Plus Pack



- The items supplied with the device and any available accessories may vary depending on the area and service provider.
- Always use genuine LG Electronics accessories. Using accessories made by other manufacturers may affect your device's call performance or cause malfunctions. This may not be covered by LG's repair service.



- If any of these basic items are missing, contact the dealer from which you purchased your device.
- To purchase additional basic items, contact an LG Customer Service Center.
- To purchase optional items, contact an LG Customer Service Center for available dealers.
- Some items in the product box are subject to change without notice.
- The appearance and specifications of your device are subject to change without notice.
- Device specifications may vary depending on the area or service provider.
- Be sure to use authentic accessories provided by LG Electronics. Using third-party accessories may damage the device or cause malfunctions.
- Remove the protective film from the Fingerprint sensor before using the fingerprint recognition feature.

Device Overview

Front View

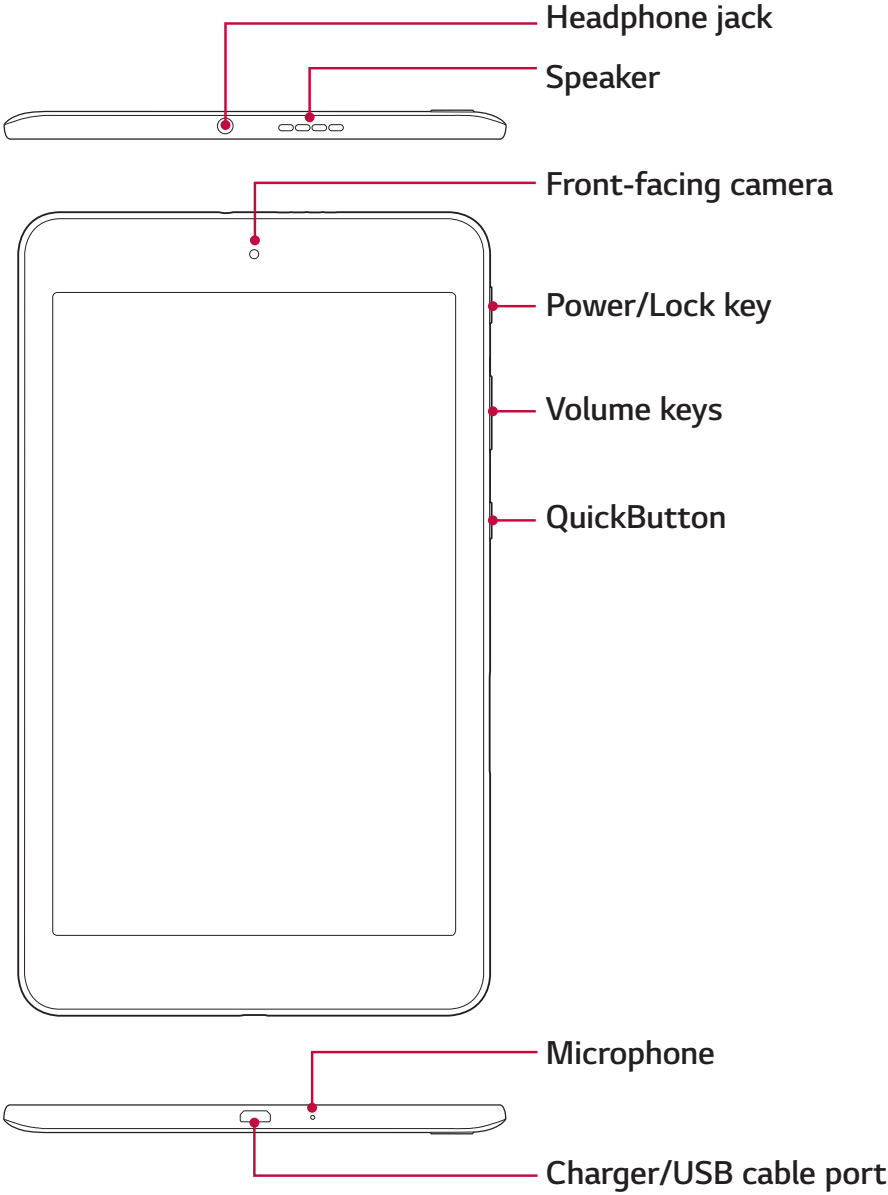

Back View

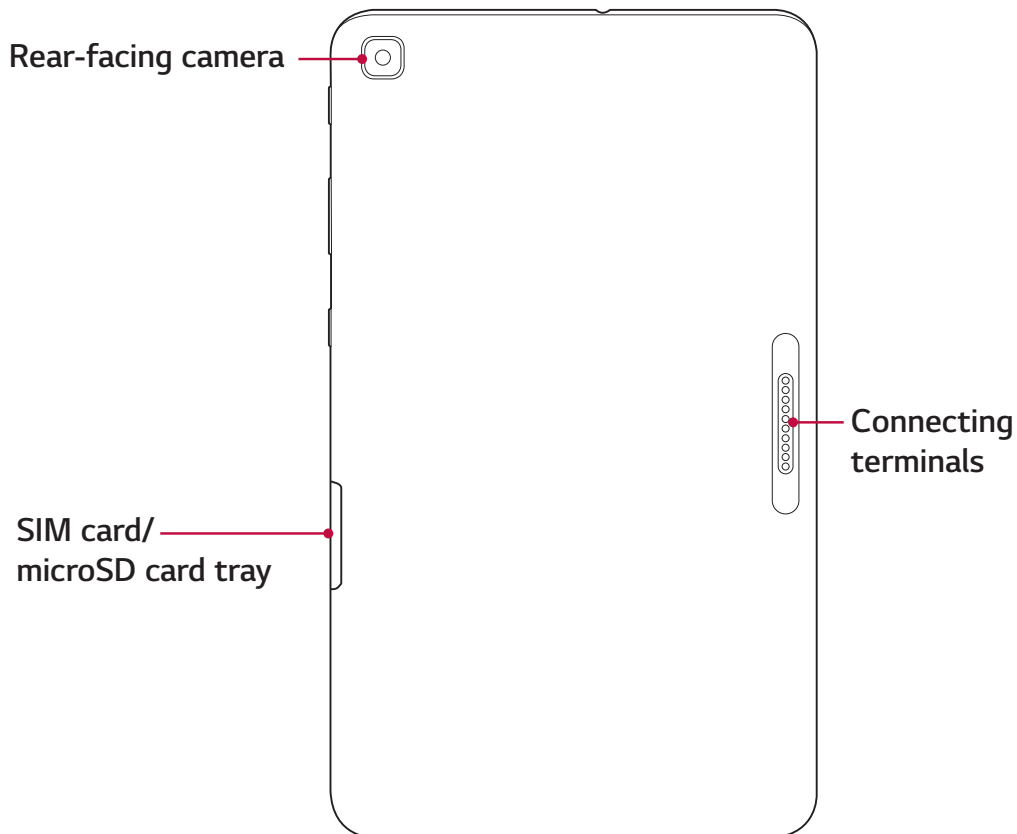

Headphone jack	Allows you to plug in an optional headset for convenient, hands-free conversations. You can also plug in headphones to listen to music.
Speaker	Use to listen to the audio from the selected function (e.g., music, videos, sound clips, etc.).
Front-facing camera	Use to take pictures and record videos of yourself. You can also use this for video chatting. Keep it clean for optimal performance.
Power/Lock key	Press to lock/unlock the screen. Press and hold to turn the tablet on/off, restart, or activate/deactivate airplane mode.

<p>Volume keys</p>	<p>While the screen is off:</p> <ul style="list-style-type: none"> • Press the Volume Up Key twice to launch Capture+. • Press the Volume Down Key twice to launch the Camera. <p>On the Home screen:</p> <ul style="list-style-type: none"> • Control ringer volume. <p>During a call:</p> <ul style="list-style-type: none"> • Control your earpiece volume. <p>When playing audio/video:</p> <ul style="list-style-type: none"> • Control volume continuously.
<p>QuickButton</p>	<p>Press to launch an app. Press and hold to change the app you wish to get quick access to. The Comfort view function is preset.</p>
<p>Microphone</p>	<p>Records your voice and allows use for voice-activated functions.</p>
<p>Charger/USB cable port</p>	<p>Allows you to connect the tablet and the USB cable for use with the charger adapter, your PC, or other compatible accessories.</p>
<p>Rear-facing camera</p>	<p>Use to take photos and record videos. Keep it clean for optimal performance.</p>
<p>SIM card/microSD card tray</p>	<p>Allows you to insert your SIM card and a microSD card.</p>
<p>Connecting terminals</p>	<p>Attach the Plus Pack matching the terminals.</p>

Plus Pack Overview

The Plus Pack is a portable speaker and battery pack designed for the LG G Pad X2 8.0 PLUS tablet.

When attached to the tablet and turned on, you can listen to the tablet's sound through the Plus Pack and charge the tablet at the same time.

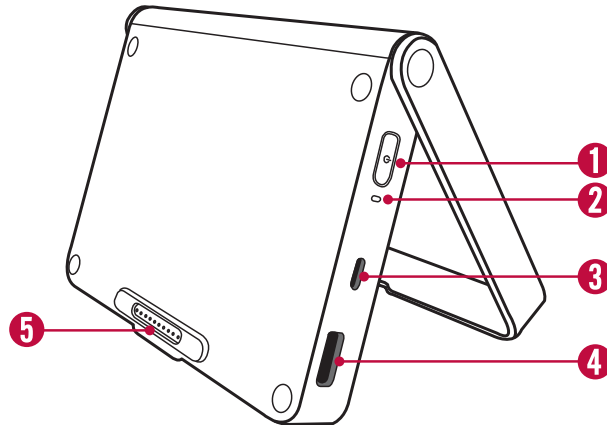

1 Power Button

Press to turn on. Press and hold to turn off.

When the tablet is attached, it will automatically turn on. Press and hold for about 2 seconds to turn off.



- Do not detach the Plus Pack while playing music or videos.
- If the tablet is detached, the Plus Pack will automatically turn off.
- If no device is connected to the Plus Pack for 15 sec, the Plus Pack will automatically turn off.

2 LED Indicator

Indicates the charging status and battery level. It is red while charging and turns green when charging is completed.

LED Indicator	Battery Level (%)
Green	40~100
Orange	15~40
Red	5~15
Red blinking	0~5

3 USB Type-B Port (micro USB cable port)

Connect a cable to charge the Plus Pack alone or the Plus Pack and the tablet together (when they are attached).

4 USB Type-A Port (Output 2) (USB Peripheral Port)

Plug a USB Type-A cable into the port to connect OTG devices (such as a keyboard) or

charge other devices.

5 Connecting Terminals (Output 1)

Attach the tablet by lining up the terminals, making sure that magnets on the Plus Pack are aligned properly with those of the tablet.

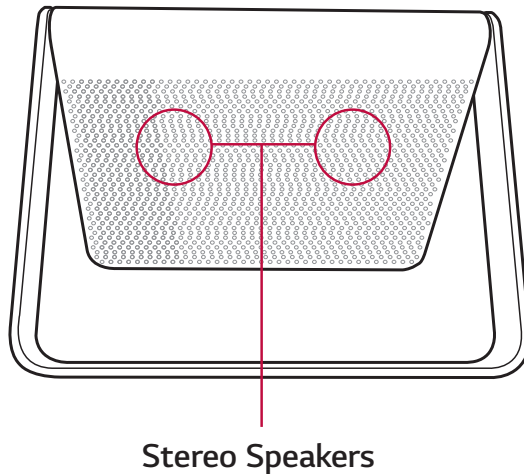

- When you connect another device to charge using a USB cable without the tablet attached, charging will start after about 4 seconds once the device checks the output mode.
- To perform a reset of the Plus Pack, simply press and hold the Power button for about 8 seconds.



- Be careful not to spill food or liquids on the connecting terminals of both the tablet and the Plus Pack. It can cause malfunctions.
- Risk of fire and burns. Do NOT open, crush, heat above 60°C/140°F or incinerate. Violation of the instructions may cause minor or serious damage to the product.

Attaching the Tablet to the Plus Pack

- 1 Simply line up the connecting terminals on the tablet and the Plus Pack, making sure that magnets on the Plus Pack are aligned properly with those of the tablet.

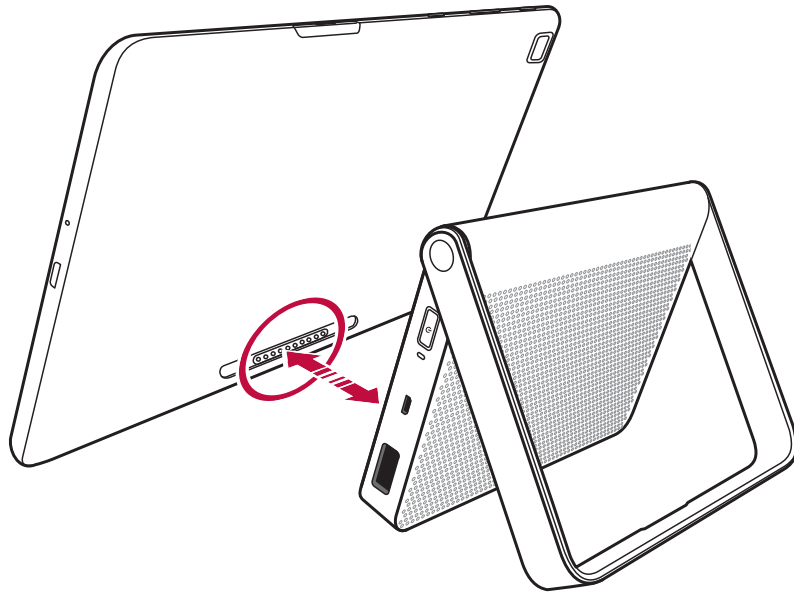

- 2 Adjust the angle of the stand holding both the tablet and the Plus Pack securely as shown below.

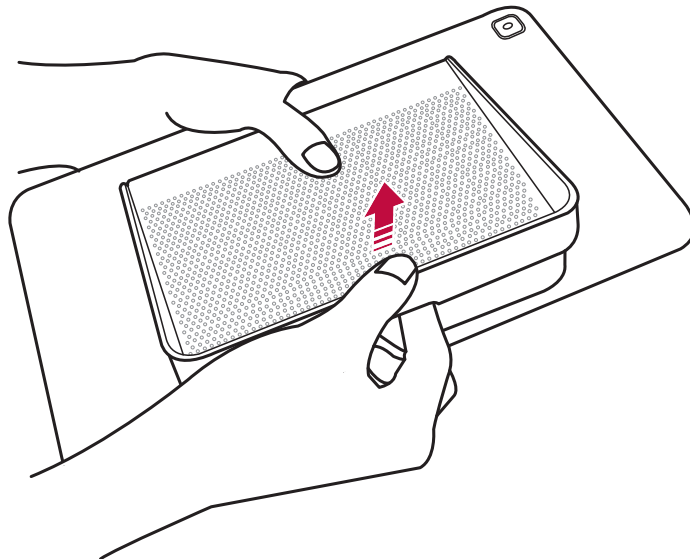



- The tablet and Plus Pack are connected by magnets. If you grab the stand alone, the Plus Pack might be separated from the tablet and the tablet might be dropped.



- Do not detach the Plus Pack while playing music or a video.
- Every time you attach or detach the Plus Pack, it is recommended that you calibrate the motion sensor. Simply hold the tablet and tilt it around making an 8 shape.
- When the tablet is attached to the Plus Pack, all the sound will come through the speaker of the Plus Pack, except for calls using VoIP.

Adjusting the Stand for Typing

When adjusting the stand, make sure that the angle is no wider than 120° with the tablet attached. If it is wider than that, the stand might fall.

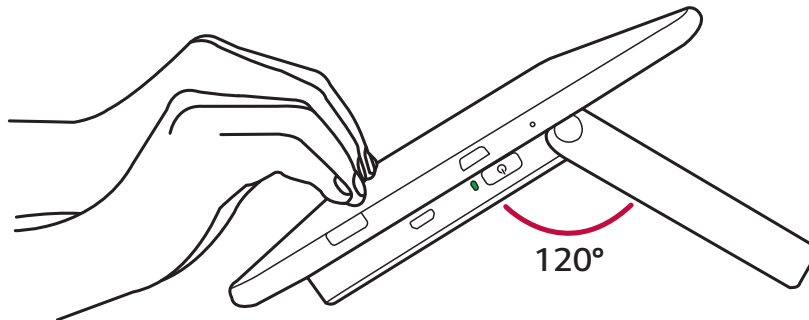

Detaching the Tablet from the Plus Pack

Detach the tablet holding both the tablet and the Plus Pack firmly as shown below.

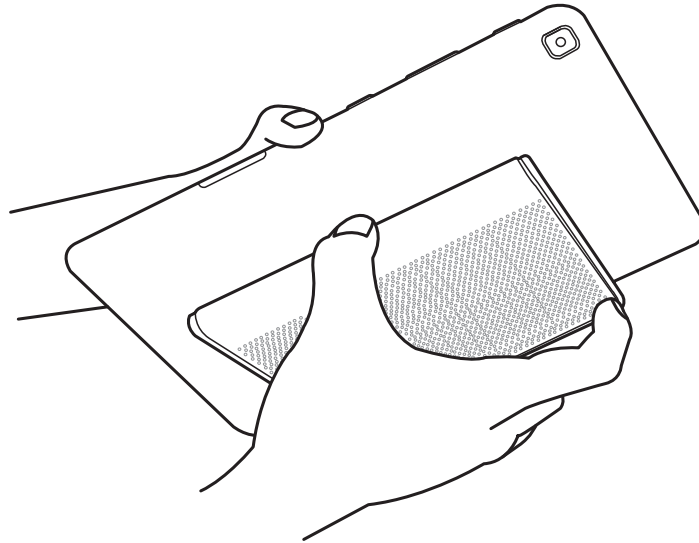

Charging the Battery

You can charge your tablet's battery using the included AC adapter.

Charging the Tablet

The Charger/USB cable port is located at the bottom of the device. Insert the charger and plug it into a power outlet.

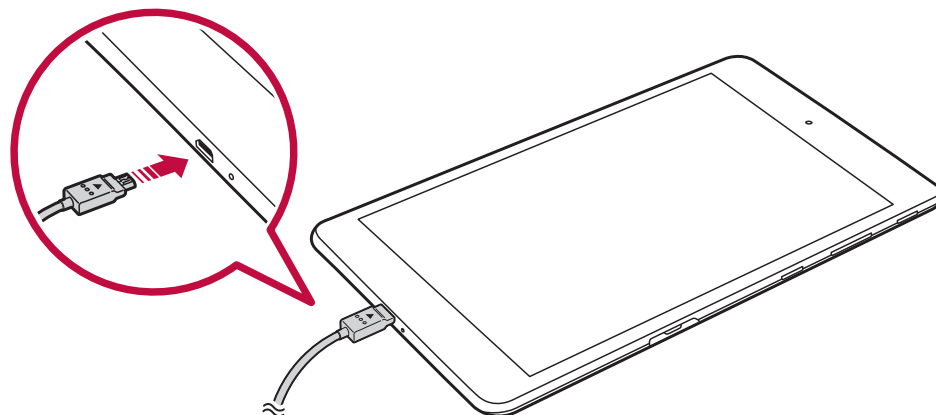

Charge the battery before using it for first time. Use the charger included with your device to charge the battery. A computer can also be used to charge the battery by connecting the device to it using the USB cable.



- Use only LG-approved chargers and cables. The use of unapproved chargers or cables may cause a battery charging delay or display a pop-up message regarding slow charging. It can also cause the battery to explode or damage the device, which is not covered by the warranty.



- Your device has an internal rechargeable battery. For your safety, do not remove the embedded battery.
- The battery must be fully charged initially to improve battery lifetime.
- Remove the charger from the power socket after the device is fully charged. This prevents unnecessary power consumption.



- **To perform a soft reset of your device**

A soft reset may be used to reset the device if the screen freezes, or the buttons, touch screen, or device are no longer responding. Simply press & hold the **Volume down** and **Power/Lock keys** until the device restarts.

Charging the Plus Pack

Plug the USB cable into the micro USB cable port (USB Type-B port) on the Plus Pack. The LED indicator turns green when the battery is fully charged.

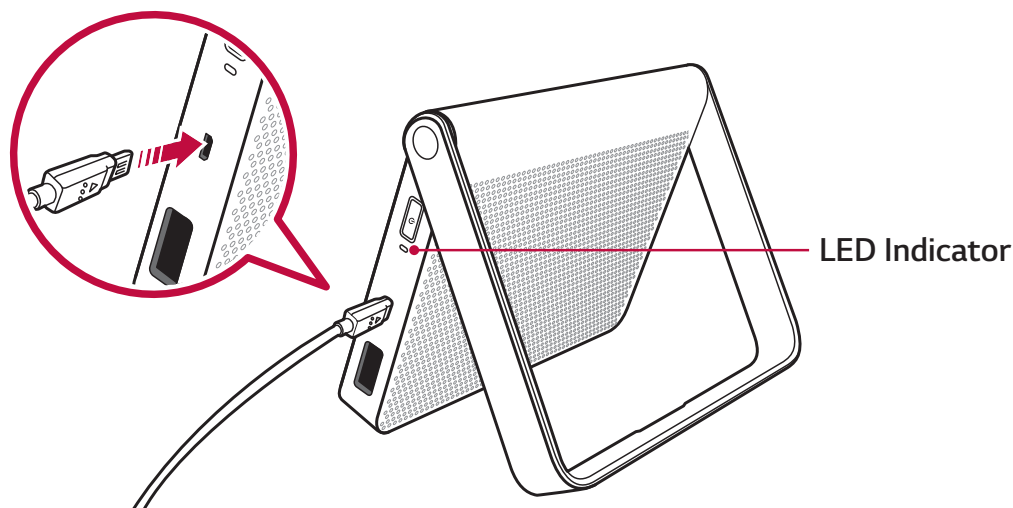

Charging the Tablet While It's Attached to the Plus Pack

To charge the tablet and the Plus Pack at the same time, plug the USB cable into the micro USB cable port on the Plus Pack while it's attached to the tablet. When both are fully charged, the LED indicator on the Plus Pack turns green and “Battery fully charged” appears on the tablet.

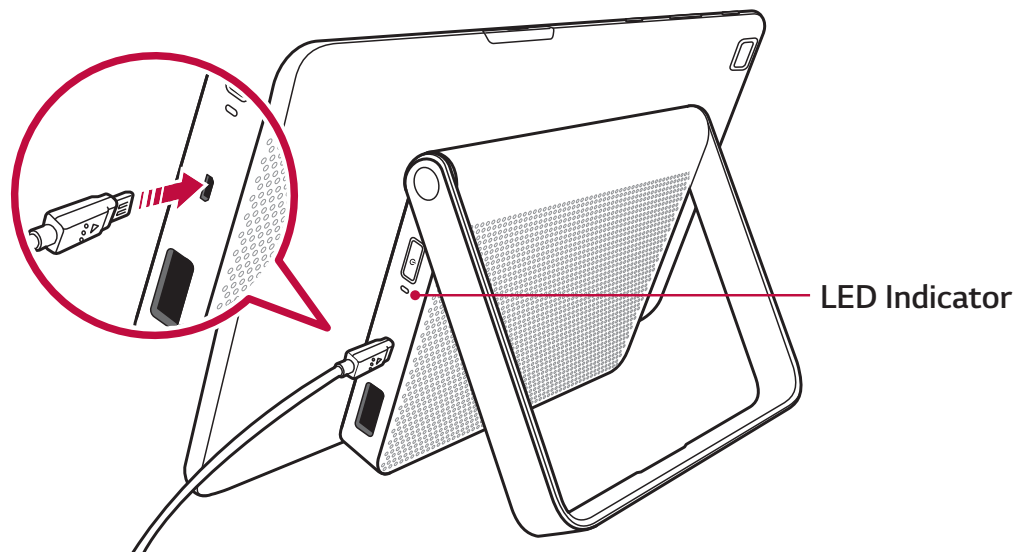

- Always unplug the charger from the wall socket after the device is fully charged to save unnecessary power consumption of the charger.

Using the Battery Efficiently

Battery lifespan may decrease if you keep many apps and functions running simultaneously and continuously.

Stop apps and functions from running in the background to increase battery life.

To minimize battery consumption, follow these tips:

- Turn off the Bluetooth® or Wi-Fi network function when not using them.
- Set the screen timeout to as short a time as possible.
- Minimize the screen brightness.
- Set a screen lock when the device is not in use.

- Check the battery usage details and close any downloaded apps that are draining the battery.

Connecting a USB Device to Your Tablet

Use the Plus Pack to connect a USB peripheral device.

- 1 Attach the tablet to the Plus Pack by matching the connecting terminals.
- 2 Plug in the USB cable into a USB peripheral device.
- 3 Insert the other end of the USB cable into the USB peripheral port (Type-A port) located on the side of the Plus Pack.

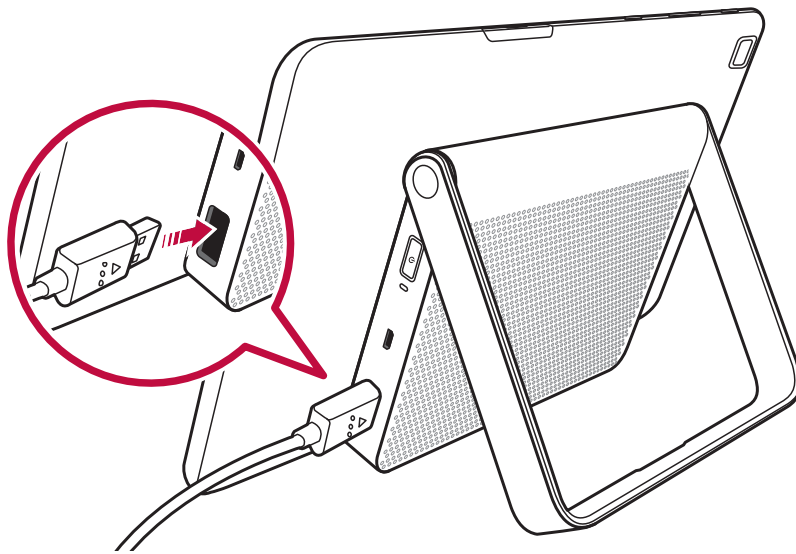

Some of the USB devices supported through the USB cable port include a keyboard, mouse, game controller, digital camera, and storage device (including an Android smartphone acting as external storage device). As most USB keyboards, mouse and game controllers are designed for desktop computers and operation systems, some devices may not function.



- Make sure all the USB cables are removed from the Plus Pack before folding the stand back.



- Only devices that meet the USB specs may connect to the USB peripheral port.
- If you are experiencing errors with device recognition, please use a shorter USB cable or check the USB Hub with external power supply (Self-Powered Hub).
- Only file systems such as FAT32, exFAT, and NTFS are supported for the external USB storage device.
- Transferring data through both USB devices at the same time is not supported. The first device that is connected has priority. The USB device connected second can only be charged.



- You cannot store data in the USB storage when the battery level is below 15%. Please charge the battery above 15% in order to use the USB storage function.

Installing the SIM Card or microSD Card

Before you can start exploring your new device, you need to set it up. Your device supports the use of microSD memory cards of up to 2TB capacity. Multimedia contents can be saved in the microSD card.

- 1 Pull out the card tray using the fingertip cutout.

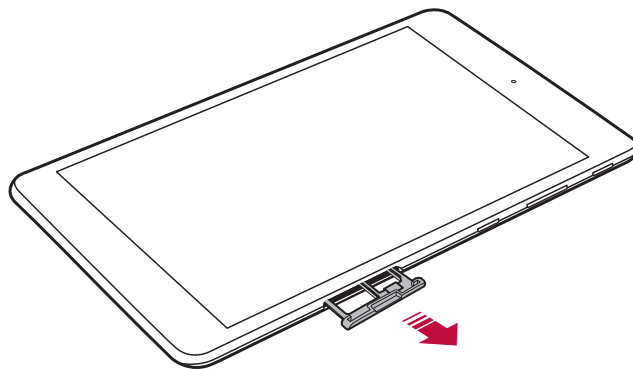

- Put the Nano-SIM card and a microSD card (optional) on the card tray, then slide the card tray into the slot as shown in the figure below. Make sure the gold contact area on the card is facing downward.

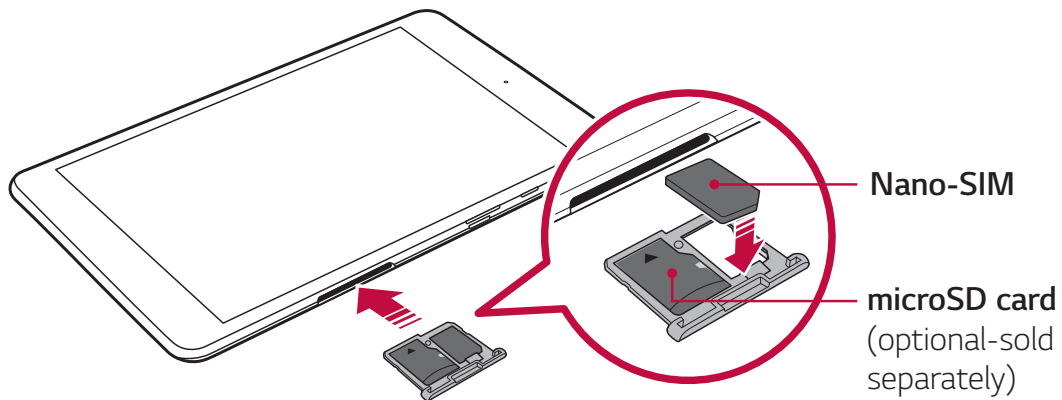

- This device supports only Nano SIM cards.

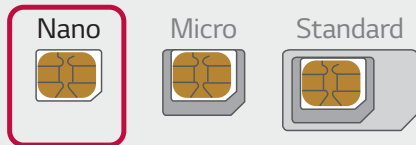



- For problem-free performance, it is recommended to use the phone with the correct type of SIM card. Always use a factory-made SIM card supplied by the service provider.
- Do not lose your SIM card. LG is not responsible for damage and other issues caused by loss or transfer of a SIM card.
- Be careful not to damage the SIM card when you insert or remove it.
- Cards must be positioned as shown.
- Do not pull out the card tray from the tablet when the tablet is turned over. The SIM card (and the microSD card) will fall off and might be lost.
- microSD card is not included.
- Depending on the memory card manufacturer and type, some memory cards may not be compatible with your device.



- Some memory cards may not be fully compatible with the device. If you use an incompatible card, it may damage the device or the memory card, or corrupt the data stored in it.

Removing the Memory Card

Before removing the memory card, first unmount it for safe removal.

- 1 Tap  >  > **Storage** > .
- 2 Pull out the card tray and remove the memory card.



- Do not remove the memory card while the device is transferring or accessing information. Doing so can cause data to be lost or corrupted or damage to the memory card or device. LG is not responsible for losses that result from the misuse of damaged memory cards, including the loss of data.

Touch Screen

You can familiarize yourself with how to control your device by using touch screen gestures.

Tapping

Lightly tap with your fingertip to select or run an app or option.

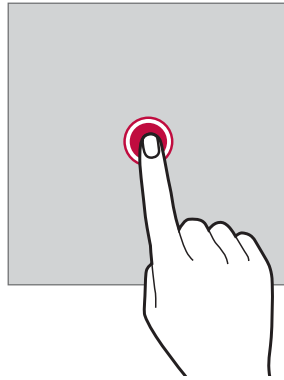

Touching and holding

Touch and hold for several seconds to display a menu with available options.

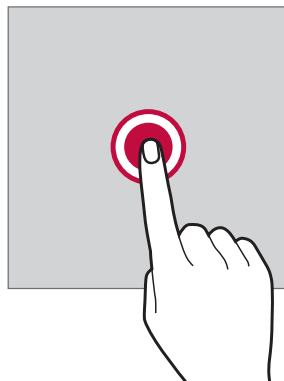

Double-tapping

Tap twice quickly to zoom in or out on a web page or map.

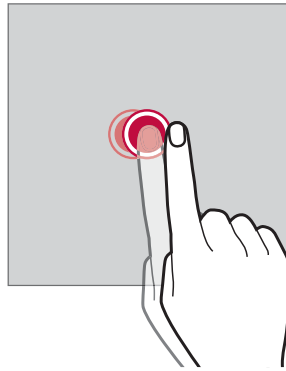

Dragging

Touch and hold an item, such as an app or widget, then move your finger to a desired location in a controlled motion. You can use this gesture to move an item.

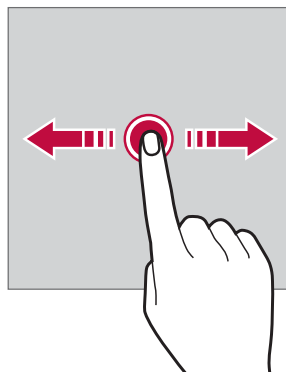

Swiping

Touch the screen with your finger and move it quickly without pausing. You can use this gesture to scroll through a list, a web page, photos, screens, and more.

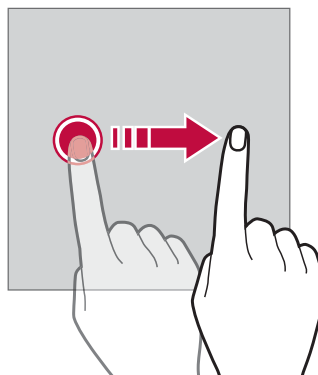

Pinching and spreading

Pinch two fingers to zoom out such as on a photo or map. To zoom in, spread your fingers apart.

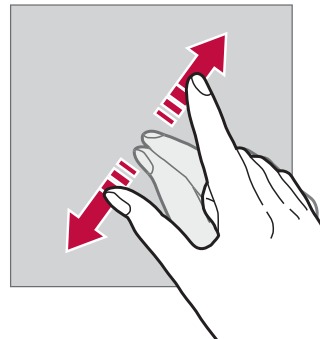
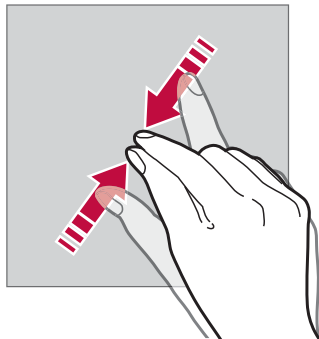

- Do not expose the touch screen to excessive physical shock. You might damage the touch sensor.



- A touch screen failure may occur if you use the device near a magnetic, metallic or conductive material.
- If you use the device under bright lights, such as direct sunlight, the screen may not be visible, depending on your position. Use the device in a shady location or a location with an ambient light that is not too bright and bright enough to read books.
- Do not press the screen with excessive force.
- Gently tap with your fingertip on the option you want.
- The touch control may not work properly if you tap while wearing a glove or by using the tip of your fingernail.
- Touch control may not work properly if the screen is moist or wet.
- The touch screen may not function properly if a screen-protective film or accessory purchased from a third party store is attached to the device.
- Displaying a static image for extended periods of time may result in afterimages or screen burn-in. Turn off the screen or avoid displaying the same image for a long time when you do not use the device.

Home Screen

Home Screen Overview

The Home screen is the starting point for accessing various functions and apps on your device. Tap  on any screen to directly go to the Home screen.

You can manage all apps and widgets on the Home screen. Swipe the screen left or right to view all installed apps at a glance.

Home Screen Layout

You can view all apps and organize widgets and folders on the Home screen.

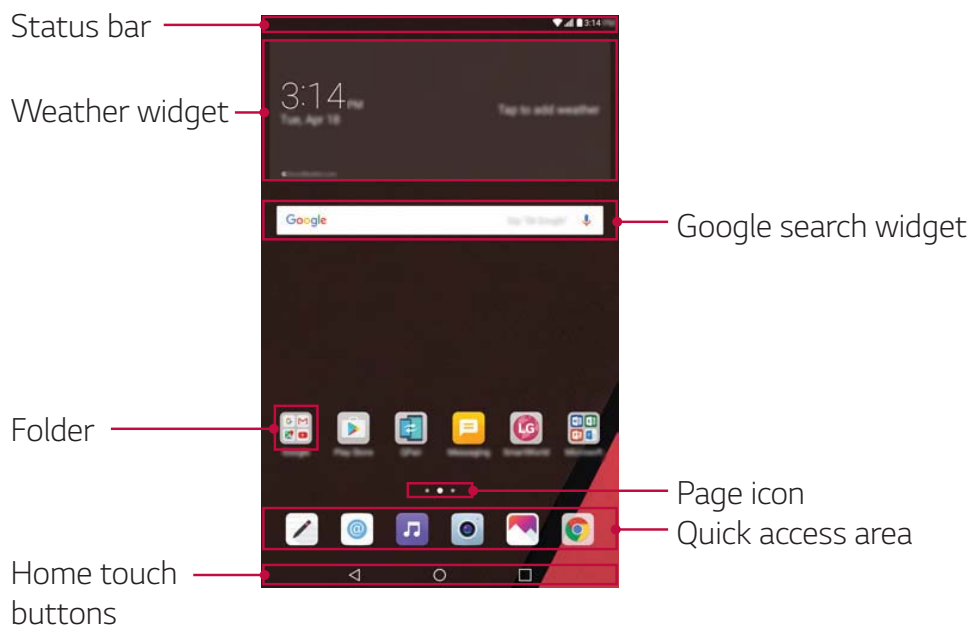

- The Home screen may vary, depending on the service provider or software version.

- **Status bar**: View status icons, the time and the battery level.
- **Weather widget**: View the weather information and time for a specific area.
- **Google search widget**: Perform a Google search by inputting spoken or written keywords.

- **Folder:** Create folders to group apps by your preferences.
- **Page icon:** Display the total number of Home screen canvases. Tap the desired page icon to go to the page you selected. The icon reflecting the current canvas will be highlighted.
- **Quick access area:** Fix main apps at the bottom of the screen so that they can be accessed from any Home screen canvas.
- **Home touch buttons**
 - ◀: Return to the previous screen. Close the keypad or pop-up windows.
 - ○: Tap to go to the Home screen. To launch Google search, touch and hold.
 - □: Tap to view a list of recently used apps or run an app from the list. To delete all the recently used apps, tap **CLEAR ALL**. To use two apps at the same time with the Multi-Window feature, touch and hold the button while using an app.

Editing the Home Touch Buttons

You can rearrange the Home touch buttons or add frequently used functions to the Home touch buttons area.





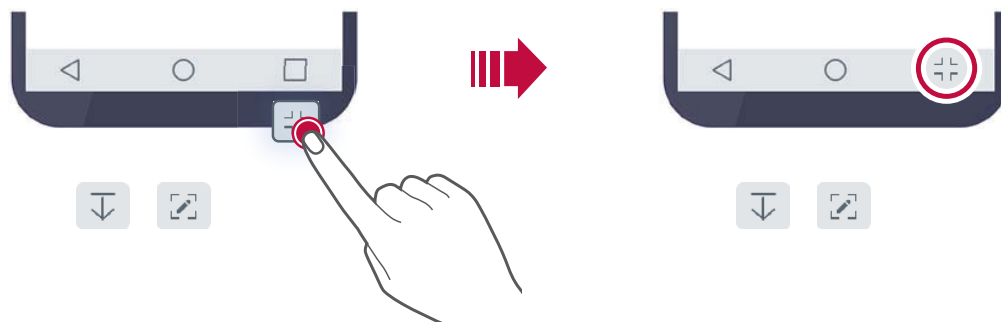







Tap ○ > ⚙ > **Display** > **Home touch buttons** > **Button combination** and customize the settings.

- Several functions, including Notification panel and Capture+, are provided. A maximum of two items can be added.



Status Icons

When there is a notification for an unread message, calendar event or alarm, the status bar displays the corresponding notification icon. Check your device's status by viewing notification icons displayed on the status bar.

	No signal
	Data is being transmitted over the network
	Alarm is set
	Bluetooth is on
	Connected to a computer via USB
	Battery level
	Airplane mode is on
	Wi-Fi is connected
	Silent mode is on
	GPS is on
	Hotspot is on
	No SIM card



- Some of these icons may appear differently or may not appear at all, depending on the device's status. Refer to the icons according to the actual environment and area in which you are using the device and your service provider.

Notifications Panel

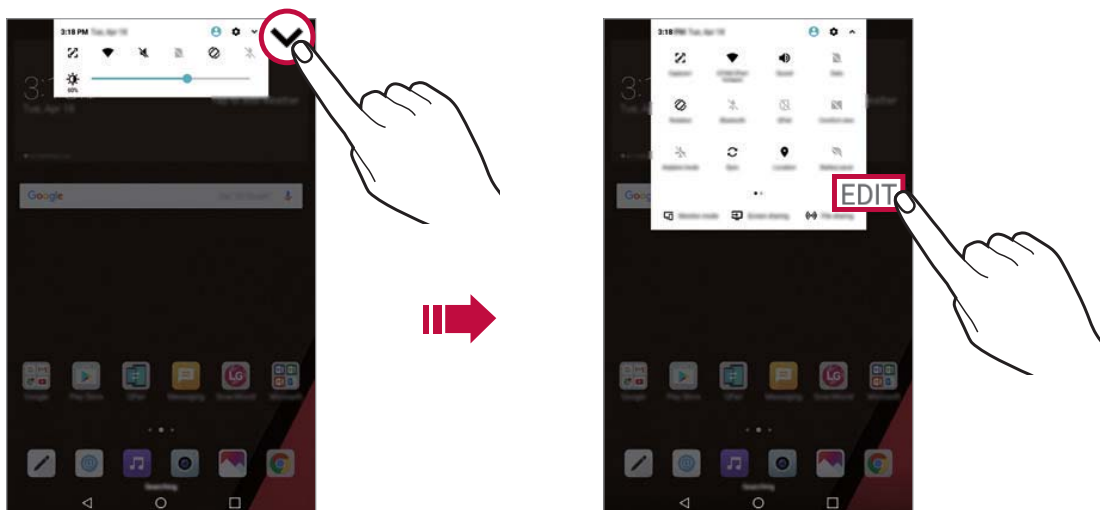

You can open the notifications panel by dragging the status bar downward on the main screen.

- To open the quick access icons list, drag the notifications panel downwards or tap .
- To rearrange, add, or remove icons, tap **EDIT**.
- If you touch and hold the icon, the settings screen for the corresponding function appears.



Switching the Screen Orientation

You can set the screen orientation to automatically switch, according to the device's physical orientation.

On the notification panel, tap **Rotation** from the quick access icon list. You can also tap  >  > **Display** and activate **Auto-rotate screen**.



Editing the Home Screen

On the Home screen, touch and hold on an empty space, then select the desired action from below.

- To rearrange the Home screen canvases, touch and hold on a canvas, then drag it to another location.
- To add a widget to the Home screen, touch and hold on a blank area of the Home screen, then select **Widgets**.
- To configure the Home screen settings, touch and hold on a blank area of the Home screen, then select **Home screen settings**. See *Home Screen Settings* for details.
- To view or reinstall the uninstalled apps, touch and hold on a blank area of the Home screen, then select **App trash**. See *App trash* for details.
- To change the default screen, touch and hold on a blank area of the Home screen, move to a desired screen, tap , then tap the screen once more.

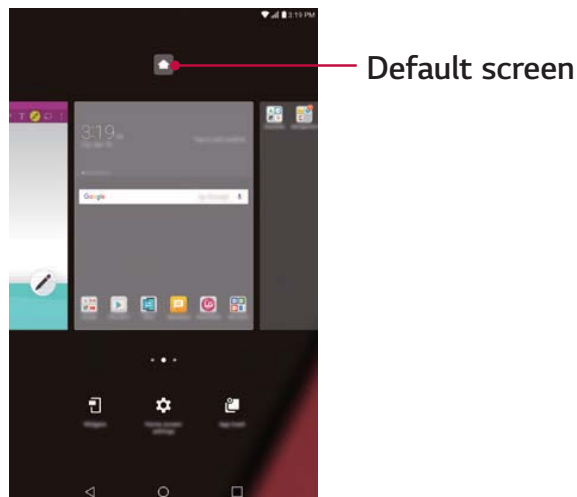

Viewing the Background Theme

You can view only the background image by hiding the apps and widgets on the Home screen.

Spread two fingers apart on the Home screen.

- To return to the original screen, which displays apps and widgets, pinch your fingers on the Home screen or tap .

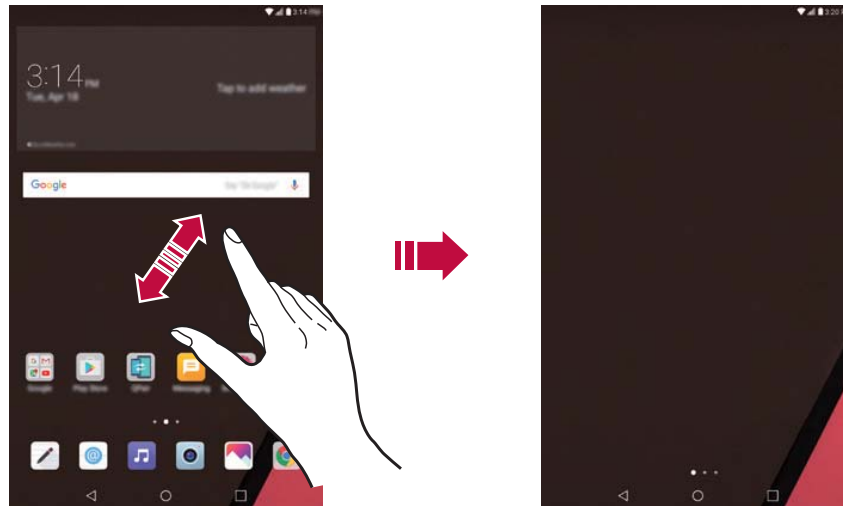

Moving Apps on the Home Screen

On the Home screen, touch and hold an app, then drag it to a desired location.

- To keep frequently used apps at the bottom (in vertical mode) or right (in horizontal mode) of the Home screen, touch and hold an app, then drag it to the quick access area at the bottom or right side.
- To remove an icon from the quick access area, drag the icon to the Home screen.

Using Folders from the Home Screen

Creating folders

On the Home screen, touch and hold an app, then drag it over another app.

- A new folder is created and the apps are added to the folder.

Editing folders

On the Home screen, tap a folder and do one of the following actions.

- To edit the folder name and color, tap the folder name.
- To add apps, touch and hold an app, then drag it over the folder and release it.

- To remove an app from the folder, touch and hold the app and drag it to outside the folder. If there is only one app remaining in the folder, the folder is removed automatically.
- You can also add or remove apps after tapping **+** in the folder.

Home Screen Settings

You can customize Home screen settings.

- 1 Tap **○** > **⚙** > **Display** > **Home screen**.
- 2 Customize the following settings:
 - **Select Home**: Select a Home screen mode.
 - **Wallpaper**: Change the Home screen background wallpaper.
 - **Screen swipe effect**: Select an effect to apply when the Home screen canvas switches.
 - **Icon shape**: Select an icon shape.
 - **Sort apps by**: Set how apps are sorted on the Home screen.
 - **Hide apps**: Select apps you want to hide from the Home screen.
 - **Continuous loop**: Enable to allow continuous Home screen scrolling (loop back to first screen after the last screen).
 - **QuickMemo+ panel**: Choose whether to add an additional home screen panel to write a memo using QuickMemo+.

Locking and Unlocking the Device

Pressing the Power/Lock Key turns off the screen and puts the device into lock mode. The device automatically gets locked if it is not used for a specified period. This helps to prevent accidental taps and saves battery power.

To unlock the device, press the **Power/Lock Key** and swipe the screen in any direction.



- Double-tapping on the screen also can wake up the screen instead of the Power/Lock Key.

Changing the Screen Lock Method

You can change the way that you lock the screen to prevent others accessing your personal information.

- 1 Tap > > **Display** > **Lock screen** > **Select screen lock**.
- 2 Select a desired screen lock from **None**, **Swipe**, **Knock Code**, **Pattern**, **PIN** and **Password**.



- If you incorrectly attempt to unlock the device 5 times, the screen is blocked for 30 seconds.

Smart Lock

You can use Smart Lock to make unlocking your device easier.

You can set it to keep your device unlocked when you have a trusted Bluetooth device connected to it, when it's in a familiar location like your home or work, when it recognizes your face or voice, or when it detects you're carrying it.

Setting up the Smart Lock feature

- 1 Tap > > **Display** > **Lock screen** > **Smart Lock**.
- 2 Enter your unlock code and select the item you want to add to Smart Lock.
- 3 Follow the instructions on the screen.







- Before you activate Smart Lock, you need to set up a screen lock (Knock Code, Pattern, PIN or Password).

On-screen Keyboard

You can enter text using the on-screen keyboard. The on-screen keyboard appears on the screen when you tap an available text entry field.

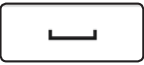
Using the keypad and entering text

Icon	Description
	Tap once to capitalize the next letter you type. Touch and hold for all caps.
	Tap to enter text by voice. Touch and hold to access hand writing, clip tray, and keyboard settings.
	Tap to enter a space.
	Tap to create a new line.
	Tap to delete the previous character.

Entering special characters

The on-screen keyboard allows you to enter special characters.

For example, to input “á”, touch and hold the “a” button until the pop-up appears and displays related special characters. Without lifting the finger, drag your finger to the desired special character. Once it’s highlighted, lift your finger.





- A symbol at the top right corner of a key indicates that additional characters are available for that key.

Connecting to Networks and Devices

Wi-Fi

You can use high-speed Internet access while within the coverage of the wireless access point (AP).



Connecting to Wi-Fi networks

- 1 Tap  >  > **Wi-Fi**.
- 2 Tap  to turn Wi-Fi on and start scanning for available Wi-Fi networks.
- 3 Tap a network to connect to it.
 - If the network is secured with a lock icon, you will need to enter a security key or password.
- 4 The Status bar displays icons that indicate Wi-Fi status.



- If you are out of the Wi-Fi zone or have set Wi-Fi to Off, the device may automatically connect to the Web using mobile data, which may incur data charges.



- **TIP! How to obtain the MAC address**
 - Tap  >  > **Wi-Fi** >  > **Advanced Wi-Fi** > **MAC address**.

Bluetooth

Bluetooth is a short-range communications technology that allows you to connect wirelessly to a number of Bluetooth devices, such as headsets and hands-free car kits, Bluetooth-enabled handhelds, computers, printers, and wireless devices.



- LG is not responsible for the loss, interception or misuse of data sent or received via the Bluetooth feature.
- Always make sure that you share and receive data with devices that are trusted and properly secured.
- If there are obstacles between the devices, the operating distance may be reduced.
- Some devices, especially those that are not tested or approved by Bluetooth SIG, may be incompatible with your device.

Pairing your device with another Bluetooth device

- 1 Tap > > **Bluetooth**.
- 2 Tap to turn Bluetooth on.
- 3 Tap **SEARCH** to view the visible devices in range.
- 4 Choose the device you want to pair with from the list. Once the pairing is successful, your device connects to the other device.



- Pairing between two Bluetooth devices is a one-time process. Once a pairing has been created, the devices will continue to recognize their partnership and exchange information.





- **TIP!**
 - Please consult documentation included with Bluetooth device for information on pairing mode and passcode (typically 0 0 0 0 – four zeroes).

Sending data via Bluetooth

- 1 Select a file or item, such as a contact or media file.
- 2 Select the option for sending data via Bluetooth.
- 3 Search for and pair with a Bluetooth-enabled device.
 - Due to different specifications and features of other Bluetooth-compatible devices, displays and operations may be different, and functions such as transfer or exchange may not be possible with all Bluetooth compatible devices.



Receiving data via Bluetooth

- 1 Tap  >  > **Bluetooth**.
- 2 Tap  to turn Bluetooth on.
- 3 You will receive a request to accept data from the sending device. Be sure to select **ACCEPT**.

Wi-Fi Direct

Wi-Fi Direct provides a direct connection between Wi-Fi enabled devices without requiring an access point.

Turning on Wi-Fi Direct

- 1 Tap  >  > **Wi-Fi**.
- 2 Tap  > **Advanced Wi-Fi** > **Wi-Fi Direct**.



- When in this menu, your device is visible to other visible Wi-Fi Direct devices nearby.

Content Sharing

Playing content from another device

You can play photos, videos or songs saved on your device from a TV.

- 1 Connect the TV and your device to the same Wi-Fi network.
- 2 While viewing the items from the **Gallery** app, tap  > **Play on other device**.
- 3 Select the TV you want to connect to.



- For use with Chromecast, Google Play services should be up to date.

Viewing content from nearby devices

You can view content from various devices, such as a computer, NAS or mobile device, by using the Gallery app.

Connecting the devices

Connect both your device and another device that support DLNA function to the same wireless network.



- Make sure that File sharing (DLNA) is activated on both the device and the connected device.

Searching for nearby devices

You can view a list of DLNA devices on the same network by selecting the **Nearby devices** menu in each app.

Use content from nearby devices as if you were using it on your device.

Sending or receiving files

You can share files between your device and another LG device, a tablet or computer.

Sending files

From the **Gallery** or **File Manager** app, tap **:** > **Share** or , then select a device on the file sharing list.

Receiving files

Drag the status bar downward and tap , then tap **File sharing**.

You can also share files using SmartShare Beam. To activate, tap  > **Share & connect** > **File sharing** > **SmartShare Beam** .



- Make sure that your device is connected to the same wireless network as the target device for the file transfer.
- Make sure that File sharing is activated on both devices.

Sending files to a computer

You can quickly send large files to your computer.

- 1 Install LG Bridge on your computer.
- 2 Start LG Bridge on the computer, then sign in using your LG account.

- 3 Tap  >  > **Share & connect** > **LG AirDrive**, then sign in using your LG account.



- You can download LG Bridge from the LG Mobile website (www.lg.com).

QPair

By connecting your tablet and mobile device via QPair, you can sync incoming calls, messages, and social networking notifications between your tablet and mobile device.

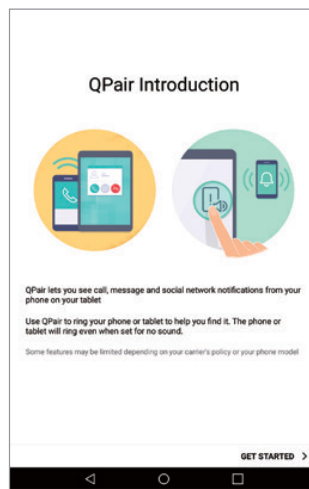

- 1 Run **QPair**  and tap **GET STARTED** > **Start** on your tablet first and then run the same steps on your device.



• TIP!

- QPair may not be pre-installed on the device. Go to the Google Play Store and search for QPair and install it.



- QPair works with devices running Android 4.1 or later. Some features may be limited depending on your device model.
- Since QPair uses the Bluetooth function, it may not work normally if you change the Bluetooth settings while QPair is in use.

- 2 Bluetooth connection will be turned on and you will be able to pair the devices.

QPair features

Call notifications – Sends the tablet a notification when the device receives a call. The notification displays the caller's number and allows you to answer and decline the call. You can also change call settings, such as a ringtone, ringtone volume, or send a decline message when you get a call.



- You can only receive calls supported by Bluetooth technology. Dialing a call from the tablet using the QPair feature is not possible.

Message notifications – Sends the tablet a notification when the device receives a message. You can also change message settings, such as message pop-up, message preview, and notification sound.

Social network notifications – Displays a social networking notification on your tablet's Status Bar when it arrives on your device.



- To use this feature, enable the QPair social network notifications option on your device.

Capture+ transfer – Saves your current Capture+ in the tablet's Gallery, and then syncs the tablet's Gallery with the Gallery on your device.

Transferring Data between a PC and Your Device

You can copy or move data between a PC and the device.

Transferring data

- 1 Connect your device to a PC using the USB cable that came with your device.
- 2 Open the Notifications panel, tap the current USB connection, and select **File transfer**.
- 3 A window will pop-up on your PC, allowing you to transfer the desired data.



- The LG United Mobile Driver is required to be installed on your PC to be able to detect the device.
- Check the requirements for using File transfer.



Items	Requirement
OS	Microsoft Windows XP SP3, Vista or higher
Window Media Player version	Windows Media Player 10 or higher

- Please refer to www.android.com/filetransfer/#tips in order to use the File transfer feature on the MAC OS.



Google Account Setup

The first time you open a Google application on your tablet, you will be required to sign in with your existing Google account. If you do not have a Google account, you will be prompted to create one.

Creating Your Google Account

- 1 Tap  >  > **Accounts & sync**.
- 2 Tap **ADD ACCOUNT** > **Google** > **Or create a new account**.
- 3 Enter your first and last name, then tap **NEXT**.
- 4 Follow the instructions and enter the required and optional information about the account. Wait while the server creates your account.

Signing into Your Google Account

- 1 Tap  >  > **Accounts & sync**.
- 2 Tap **ADD ACCOUNT** > **Google**.
- 3 Enter your email address and tap **NEXT**.
- 4 Enter your password and tap **NEXT**.
- 5 After signing in, you can use Gmail and take advantage of Google services on your tablet.

- 6 Once you have set up your Google account, your tablet will automatically synchronize with your Google account on the web (if a data connection is available).

After signing in, your tablet will sync with your Google services, such as Gmail, Contacts, and Google Calendar. You can also use Maps, download applications from Play Store, back up your settings to Google servers, and take advantage of other Google services on your tablet.

Installing and uninstalling apps

Installing apps

Access an app store to search and download apps.

- You can use the SmartWorld, Play Store or the app store provided by your service provider.



- Some app stores may require you to create an account and sign in.
- Some apps may charge fees.
- If you use mobile data, you may be charged for data usage, depending on your pricing plan.
- SmartWorld may not be supported depending on the area or service provider.

Uninstalling apps

Uninstall apps that you no longer use from your device.

Uninstalling with the touch and hold gesture

On the Home screen, touch and hold the app to uninstall, then drag it over **Remove** at the top of the screen.

You can also touch and hold the app and release it, then tap  to uninstall.

- Uninstalled apps can be reinstalled within 24 hours of uninstallation. See *App trash* for details.

Uninstalling by using the settings menu

Tap  >  > **Apps**, select an app, then tap **Uninstall**.

Uninstalling apps from the app store

To uninstall an app, access the app store from which you download the app and uninstall it.



- Some apps cannot be uninstalled by users.

App trash

You can view the uninstalled apps on the Home screen. You can also reinstall apps within 24 hours of uninstallation.

- 1 Touch and hold an empty area of the Home screen, then tap **App trash**.
- 2 Choose the desired option.
 - **Restore**: Reinstall the selected app.
 - : Remove the uninstalled apps permanently from the device.



- Uninstalled apps are automatically removed from the device 24 hours after they were uninstalled. If you want to reinstall the uninstalled apps, you must download them again from the app store.
- This feature is activated on the default Home screen only. If you uninstall apps while using other launcher, they are immediately and permanently removed from the device.





Useful Apps





Contacts

You can add contacts on your device and synchronize them with the contacts in your Google Account or other accounts that support syncing contacts.

Searching for a Contact

- 1 Tap  > **Essentials** folder > .
- 2 Tap **Search contacts** and enter the contact name using the keyboard.



Adding a New Contact

- 1 Tap  > **Essentials** folder >  > .
- 2 Select the desired account (if applicable).
- 3 If you want to add a picture to the new contact, tap . Choose **Take photo** or **Select photo**.
- 4 Enter the desired information for the contact.
- 5 Tap **SAVE**.



Favorites Contacts

You can classify frequently called contacts as favorites.

Adding a contact to your favorites



- 1 Tap  > **Essentials** folder > .
- 2 Tap a contact to view its details.
- 3 Tap the star at the top right of the contact details screen. The star will be highlighted.

Removing a contact from your favorites list

- 1 Tap  > **Essentials** folder > .
- 2 Choose a contact from the **FAVORITES** list at the top of the contact's list.

- 3 Tap the highlighted star at the top right of the contact details screen. The highlight will be removed from the star and the contact is removed from your favorites.

Creating a Group



- 1 Tap  > **Essentials** folder > .
- 2 Tap **Groups** > .
- 3 Enter a name for the new group.
- 4 Tap **Add members** to add contacts to the group.
- 5 Tap **SAVE** to save the group.



- If you delete a group, the contacts assigned to that group will not be lost. They will remain in your contact list.

Merging and Separating Contacts

When you have two or more entries for the same contact, you can merge them into a single entry. You can also separate contacts that were merged.

- 1 Tap  > **Essentials** folder > .
- 2 Tap  > **Manage contacts** > **Merge**.
- 3 Select a tab at the top of the screen.
 - Tap **Merge suggestion** to select entries you want to merge.
 - Tap **Merged contacts** to select entries you want to separate.
- 4 Checkmark the entry (or entries) you want to merge or separate, then tap the **Merge** or **Separate** button.

Messaging

Your phone combines text and multimedia messaging into one intuitive, easy to use menu.





- You may be charged for each message you send. Please consult with your service provider.

Sending a Message

- 1 Tap  >  > .
- 2 Tap , then select one or more entries from your Contacts list.

OR

Enter a contact name or contact number into the **To** field. As you enter the contact name, matching contacts appear. You can tap a suggested recipient and add more than one contact.

- 3 Tap the text field and start entering your message.
- 4 Tap  to open the options menu. Choose from any of the available options.
- 5 Tap  to attach the file that you want to share with the message.
- 6 Tap **Send** to send your message.

Conversation View

Messages exchanged with another party are displayed in chronological order so that you can conveniently see and find your conversations.

Changing Your Messaging Settings

Your phone's messaging settings are predefined to allow you to send messages immediately. You can change the settings based on your preferences.

- Tap  >  >  > **Settings**.

Email

The Email application allows you to use email accounts other than Gmail, and supports the following account types: POP3, IMAP and Microsoft Exchange (for Enterprise users).

Managing Email Accounts

To open the Email application

The first time you open the Email application, a setup wizard opens to help you add an email account. You can also add your email account using the **Settings** menu.

- Tap  > .





Adding another email account:

- Tap  >  >  > **Settings** > .

Changing the email general settings:

- Tap  >  >  > **Settings**.



Deleting an email account:

- Tap  >  >  > **Settings** >  > **Remove account** > Select the account(s) you want to delete (if necessary) > **REMOVE** (if necessary) > **REMOVE**.

Working with Account Folders

Each account has Inbox, Sent, and Drafts. Depending on the features supported by your account's service provider, you may have additional folders.

Composing and Sending Email

- 1 In the **Email** application, tap  to create a new email.
- 2 Enter an address for the message's intended recipient. As you enter text, matching addresses will be offered from your contacts. Separate multiple addresses with semicolons.
- 3 Tap the **Cc/Bcc** field to copy or blind copy to other contacts/email addresses.
- 4 Tap the text field and enter your message.
- 5 Tap  to attach the file you want to send with your message.
- 6 Tap  to send the message.

Camera and Video

Camera Options on the Viewfinder

You can use the camera or camcorder to take and share pictures and videos.

- Tap  > .



- Be sure to clean the protective lens cover with a microfiber cloth before taking pictures. A lens cover with smudges from fingers can cause blurry pictures with a "halo" effect.

Rear Camera



Front Camera



Customizing the Camera Options

You can customize a variety of camera options to suit your preferences. Tap  on the screen.



- Available options vary depending on the selected camera (front or rear camera) and the selected camera mode.

Photo size	Select the desired value for the aspect ratio and size of your photos.
Video resolution	Select the desired value for resolution and size of your videos.
HDR	Obtain photos in vivid colors and get compensated effects even when they are taken against the light. These functions are provided by the high dynamic range (HDR) technology equipped in the camera.
Timer	Set the timer to automatically take photos after a specified period of time.
Voice shutter	Take photos with voice commands.
Tag locations	Save the image with GPS location data.
Grid	Display guide grids so that you can take photos or record videos based on the horizontal and vertical reference lines.
Simple view	Hide all menus from the camera screen.

Additional options on the front camera

Selfie shot	Customize the selfie shot settings. <ul style="list-style-type: none">• Gesture shot: Shoot using the Gesture shot feature.• Auto shot: Shoot when the camera detects a face.
Save as flipped	Save as flipped images after taking selfies.

Taking a Photo

- 1 Open the Camera application and point the lens toward the subject you want to photograph.
- 2 Focus indicators will appear in the center of the viewfinder screen. You can also tap anywhere on the screen to focus on that spot.
- 3 When the focus indicators turn green, the camera has focused on your subject.
- 4 Tap  to capture the photo.

Selfie shot

You can use the front camera to view your face on the screen and take selfies.

Gesture shot

You can take selfies by using gestures.

Show your palm to the front camera and then clench your fist.

You can also clench your fist and then open it towards the front camera.

- In three seconds, a photo is taken.

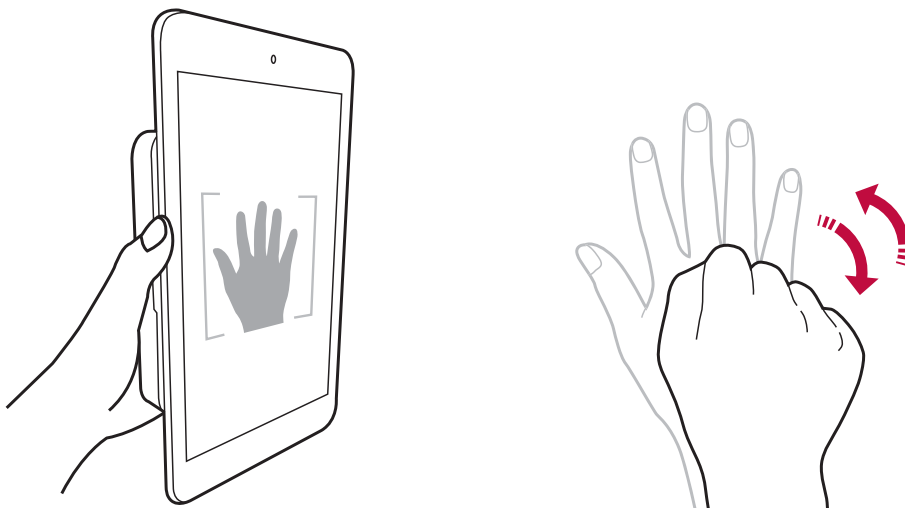



- To use this feature, switch to the front camera mode, then tap  > **Selfie shot** > **Gesture shot**.
- Make sure that your palm and fist are within the reference line so that the camera can detect them.
- This feature may not be available while using some of the camera features.

Interval shot

You can take selfies at an interval.

While using the front camera, you can show your palm to the camera, then clench your fist twice quickly.

- Four photos are taken at about two second intervals after a timer delay of three seconds.



- Tap  > **Selfie shot** > **Gesture shot** to use this feature.

Auto shot

You can use the face detection feature to take selfies easily and conveniently. You can set the device so that, when you look at the screen, the front camera detects your face and takes a selfie automatically.

- The white colored guide frame appears when the front camera detects your face. If the subject within the guide frame stops moving, the guide frame color turns blue, then the camera takes a photo.



- Tap  > **Selfie shot** > **Auto shot** to enable the Auto shot feature.

Save as flipped

Before taking a photo with the front camera, tap  > **Save as flipped**. The image is flipped horizontally.



- When using the front camera, you can change how selfies are taken in the camera options. See *Customizing the Camera Options* for details.

Recording a Video



- 1 Open the **Camera** application and point the lens toward the subject you want to capture in your video.
- 2 Tap  once to start recording.



- The timer will be displayed on the screen.



- 3 Tap  to stop recording.



-  – Tap to capture a screen shot while recording a video.
-  – Tap to pause the recording.

Gallery

The Gallery application presents the pictures and videos in your storage, including those you've taken with the Camera application and those you downloaded from the web or other locations.

- 1 Tap  > .
- 2 Tap an album to open and view its contents. (The pictures and videos in the album are displayed in chronological order.)
- 3 Tap a picture in an album to view it.



- Some file formats may not be supported, depending on the installed software.
- Some files may not be opened due to encoding.
- Files that exceed the size limit may cause an error.

Viewing pictures

The Gallery displays your pictures in folders. When some apps save a picture, a folder is automatically created to contain the picture.

Pictures are displayed by the date they were created. Select a picture to view it full screen. Scroll left or right to view the next or previous image.

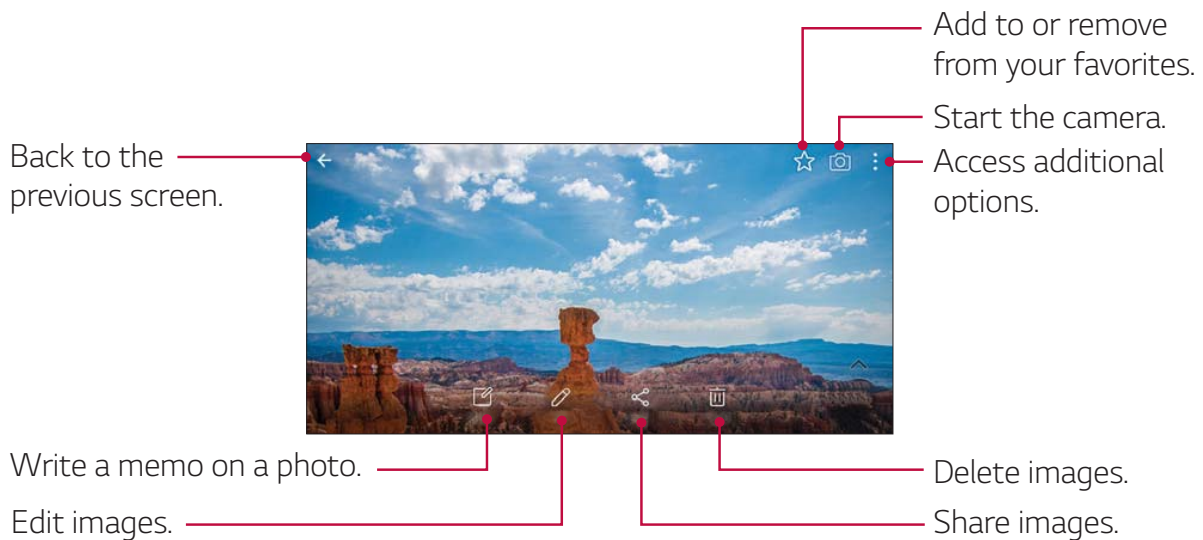

- To display the menu items, gently tap the screen. To hide the menu items, tap the screen again.

Zooming in and out

Use one of the following methods to zoom in and out on an image:

- Double-tap anywhere to zoom in and out.
- Spread two fingers apart on any place in the picture zoom in. Pinch in to zoom out.



Writing a memo on the photo

- 1 While viewing a photo, tap .
- 2 Write a memo on the photo and tap **SAVE**.



• Some photos may not support the photo memo feature.

Editing photos

- 1 While viewing a photo, tap .
- 2 Use a variety of effects and tools to edit the photo.
- 3 Tap **SAVE** to save changes.
 - The changes are overwritten to the original file.
 - To save the edited photo as another file, tap  > **Save copy**.

Playing a video

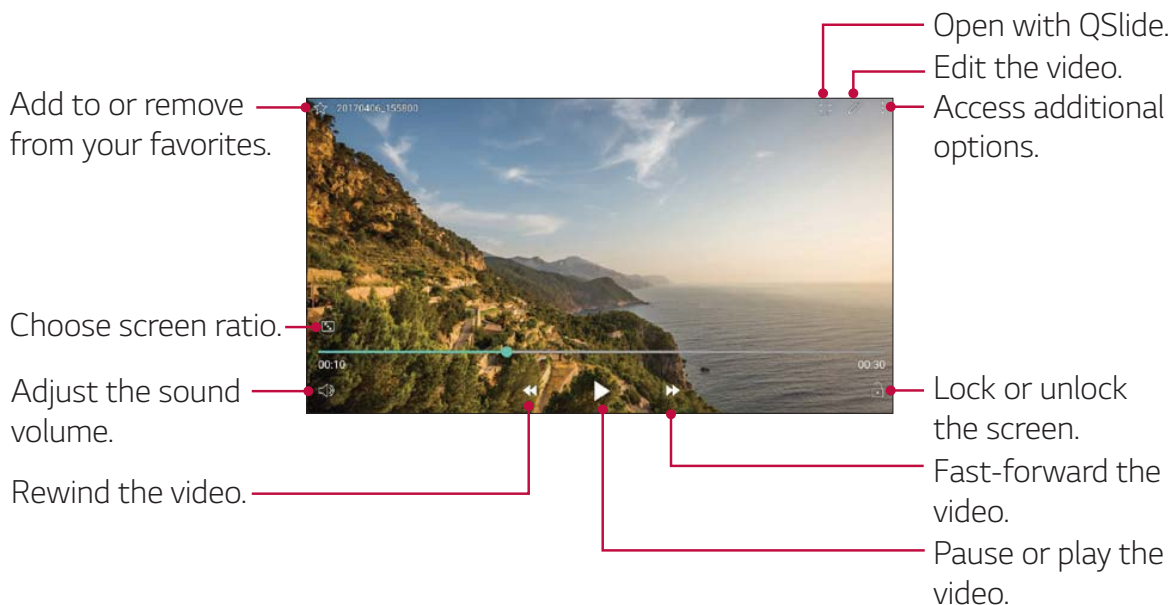



- To adjust the sound volume, drag the right side of the video screen up or down.
- To adjust the screen brightness, drag the left side of the video screen up or down.

Editing videos

- 1 While viewing a video, tap .
- 2 Use a variety of effects and edit tools to edit the video.



- 3 Tap **SAVE** to save changes.

Making a GIF file

You can easily make a GIF file using previously recorded video. At the desired starting point while watching the video, tap  > **Create GIF**.



- The GIF file is generated for the time selected from the current time.
- For videos less than 5 seconds, GIF images are automatically generated for the remaining time.



- The GIF making feature is provided for the user's creative activity. If you infringe other's copyright or defamation laws by using the GIF making feature, you may be liable for civil and criminal liability. Be sure to not duplicate or transfer the work of others without permission. LG Electronics cannot accept any liability for the user's action.



Deleting files

You can delete files by using one of the following options:

- Touch and hold a file from the file list, then tap **Delete**.
- Tap  from the file list and delete the desired files.
- Deleted files are automatically moved to **Trash** and they can be restored to the Gallery within 7 days.
- On the Gallery, tap  > **Trash**. Tap  to completely delete the files. In this case, the files cannot be restored.

Sharing files

You can share files by using one of the following options:

- While viewing a photo, tap  to share the file by using a desired method.
- While viewing a video, tap  > **Share** to share the file by using a desired method.
- Tap  from the file list to select files and share them using a desired method.

Setting a photo as a wallpaper

While viewing a photo, tap  > **Set image as** to set the image as wallpaper for the Home screen or lock screen.





- Depending on the software installed, some file formats may not be supported.
- If the file size exceeds the available memory, an error can occur when you open files.

Music

You can play and manage songs or music albums.

Playing a song

- 1 Tap  > .
- 2 Select a category.
- 3 Select a music file.

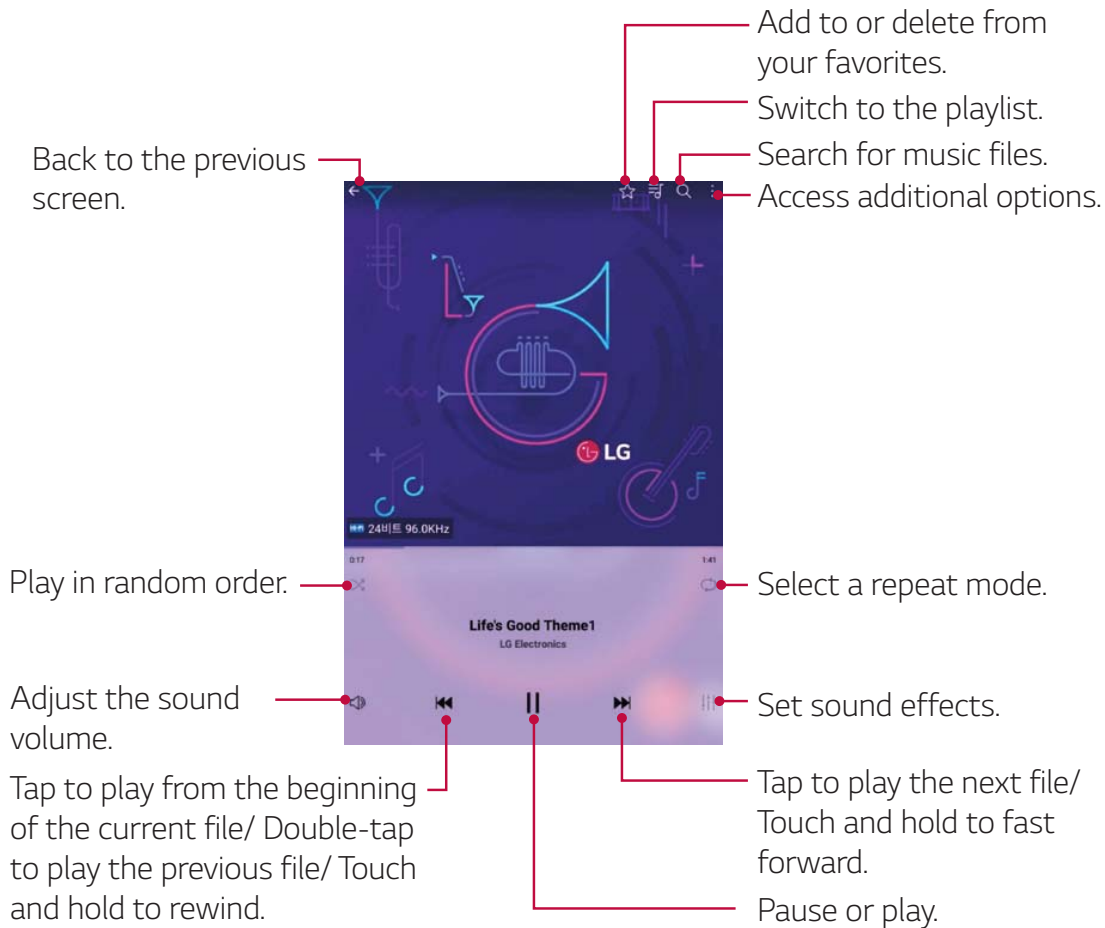



- Some file formats may not be supported, depending on the installed software.
- Files that exceed the size limit may cause an error.
- Music files may be protected by international copyright owners or copyright laws. You may have to obtain legal permission before copying a music file. To download or copy a music file, first check the copyright law for the relevant country.
- This model supports Hi-Fi audio playback. Hi-Fi audio files display the Hi-Fi icon.

LG SmartWorld

You can download a variety of games, audio content, apps and fonts provided by LG Electronics. Customize your device to suit your preferences by using Home themes and fonts.



- If you use mobile data, you may be charged for data usage depending on your pricing plan.
- This feature may not be supported depending on the area or service provider.

- 1 Tap > .
- 2 Tap > **LG Account**, then sign in.
- 3 Select and download the desired content items.

Downloading SmartWorld app



If the SmartWorld app is not installed, follow these steps to download it.

- 1 Tap > > **About tablet** > **Update center** > **App Updates**.
- 2 From the list, tap the **Download** button next to **SmartWorld**.

Clock

Alarm

You can set an alarm to trigger it at a specified time.



- 1 Tap  > **Essentials** folder >  > **Alarm**.
- 2 Tap  to add a new alarm.
- 3 Configure the alarm settings and tap **SAVE**.



- If you select a previously set alarm, you can edit the alarm.
- To delete an alarm, tap  at the top of the screen. You can also touch and hold the alarm.



World Clock

You can view the current time in cities around the world.

- 1 Tap  > **Essentials** folder >  > **World clock**.
- 2 Tap  and add a city.



Timer

You can set the timer to trigger an alarm after a specified period of time.

- 1 Tap  > **Essentials** folder >  > **Timer**.
- 2 Set the time and tap **Start**.
 - To suspend the timer, tap **Pause**. To resume the timer, tap **Resume**.
- 3 Tap **Stop** to stop the timer alarm.

Stopwatch



You can use the stopwatch to record a lap time.

- 1 Tap  > **Essentials** folder >  > **Stopwatch**.
- 2 Tap **Start** to initiate the stopwatch.
 - To record a lap time, tap **Lap**.

- 3 Tap **Pause** to suspend the stopwatch.
 - To resume the stopwatch, tap **Resume**.
 - To clear all the records and restart the stopwatch, tap **Reset**.

Calculator

You can use two types of calculators: the simple calculator and the scientific calculator.



- 1 Tap  > **Essentials** folder > .
- 2 Use the keypad to make a calculation.
 - To use scientific calculator, drag the green colored slide bar located in the right side of the screen to the left.
 - To restart a calculation, touch and hold the **DEL** button.

Calendar

Calendar overview

You can use the calendar to manage events and tasks.

Adding events

- 1 Tap  > **Essentials** folder > .
- 2 Select a date and then tap .
- 3 Enter event details and tap **SAVE**.
 - If you tap a date from the calendar and the date contains events, a pop-up window appears showing a list of the events. Tap an event from the pop-up window to view the event details.

Syncing events

Tap  > **Calendars to sync** and select a calendar to sync.





- When your events are saved from the device to your Google account, they are automatically synced with the Google calendar, too. Then, you can sync other devices with the Google calendar in order to make those devices have the same events that your device has and to manage your events on those devices.

Event pocket



You can use the event pocket to create events.

Tap  to open the event pocket and then drag content to a date in the calendar.

- : Manage images, text, memos and temporarily saved events. You can also share text, images and memos from another app and save them to the pocket. If you tap **POCKET** when creating an event, the event is temporarily saved to the pocket.
- : Manage tasks that have no deadline, such as events.





Tasks

You can register tasks to your device to easily manage schedules.

- 1 Tap  > **Essentials** folder > .
- 2 Tap  to add a task.
- 3 Enter task details and then tap **SAVE**.



Audio Recorder

You can record and save audios. Recorded audio files can be played back or shared.

- 1 Tap  > **Essentials** folder > 
 - To save the location details of recording, tap  > **Add tags** > **Add** (under **Location**).
 - To add an event, tap  > **Add tags** > **Add** (under **Event**).

- To select where to save the audio file, tap  > **Settings** > **Save to**, then tap the desired storage.

2 Tap .

- To pause recording, tap .
- To resume recording, tap .
- To bookmark a moment while recording, tap .

3 Tap  to end the recording.

- The file is saved automatically.

4 Tap  to view and play recorded audios.







File Manager

You can view and manage files saved on your device or cloud.

1 Tap  > **Management** folder > .

2 Tap a storage location.

3 The following options are available.

	Search files
	Open Dual window while using File Manager
	Add a new folder
	Move files
	Copy files
	Delete files
	Access additional options





Downloads

Use this application to see what files have been downloaded through the applications.

- Tap  > **Management** folder > .

LG Mobile Switch

You can back up, restore and move the data saved on your device.

- 1 Tap  > **Management** folder > .
You can also tap  >  > **Backup & reset** > **LG Mobile Switch**.
- 2 Follow the on-screen instructions to select a desired method for transfer.



- Resetting your device may delete backup files saved in internal storage. Make sure to copy and store the important backup files to your PC.

Google Apps

Google provides entertainment, social network, and business apps. You may require a Google account to access some apps.

To view more app information, access each app's help menu.



- Some apps may not be available depending on the region or service provider.

Google

Search quickly for items on the Internet or your device.

Gmail

Send or receive emails via the Google Mail service.

Maps

Find your location on the map, search for locations, and view location information for various places.

YouTube

Watch or create videos and share them with others.

Drive

Store your content on the cloud, access it from anywhere, and share it with others.

Play Music

Discover, listen to, and share music on your device.

Play Movies & TV

Watch movies and TV shows purchased from the Play Store.

Hangouts

Chat with your friends individually or in groups and use images, emoticons, and video calls while you are chatting.

Photos

Manage photos, albums, and videos that you have saved on the device and uploaded to Google+.



Settings

Settings

The Settings application contains most of the tools for customizing and configuring your device. All of the settings in the Settings application are described in this section.

To Open the Settings Application

- Tap  > .

WIRELESS NETWORKS

Airplane Mode

Airplane Mode (flight mode) allows you to use many of your device's features, such as games, and music, when you are in an area where data use is prohibited. When you set your device to Airplane Mode, it cannot access online data.

Wi-Fi

Turns on Wi-Fi to connect to available Wi-Fi networks.

Bluetooth

Turns the Bluetooth wireless feature on or off to use Bluetooth.

Mobile Data

Displays the data usage and allows you to set a personalized mobile data usage limit.

Share & Connect

- **File sharing** – You can send and receive files between your device and other LG devices or tablets.
 - **LG G Pad X2 8.0 PLUS** – Set your device's name.
 - **Save to** – Set the destination folder to save files sent from other devices.
 - **File sharing** – Permit receipt of files sent from other devices.
 - **SmartShare Beam** – Share files with other devices via SmartShare Beam.
 - **Help** – Displays help information about using the file sharing feature.
- **Media server** – You can share media content on your device with nearby devices that support DLNA.
 - **Content sharing** – Share content on your device with nearby

devices.

- **LG G Pad X2 8.0 PLUS** – Set your device's name.
- **Content to share** – Select the type of media content to share with other devices.
- **Allowed devices** – View a list of devices permitted to access content on your device.
- **Not-allowed devices** – View a list of devices not permitted to access content on your device.
- **Screen sharing** – You can mirror your tablet screen and sound onto Miracast dongle or TV wirelessly.
- **Monitor mode** – Project a mobile device screen and audio to this tablet using Miracast.
- **LG AirDrive** – Allows you to connect to your PC to manage your tablet. Download LG Bridge from the LG Electronics website on your PC before use. When you sign in to the same LG Account on your tablet and PC, you can use the LG AirDrive function.
- **Printing** – Allows you to print the content of certain screens (such as web pages displayed in Chrome) to a printer connected to the same Wi-Fi network as your Android device.

Tethering

- **USB tethering** – Allows you to share the internet connection with your computer via a USB cable.
- **Mobile HotSpot** – You can also use your phone to provide a mobile data connection. Create a hotspot and share your connection.
- **Help** – Displays help information for USB tethering and Mobile HotSpot.

More

- **Mobile networks** – Set options for network operators, access point names, and mobile data.

- **VPN** – From your device, you can add, set up, and manage virtual private networks (VPNs) that allow you to connect and access resources inside a secured local network, such as your corporate network.

DEVICE

Sound

Sound profile

Allows you to set the sound profile to **Sound** and **Silent**.

Volume

Adjust the device's volume settings to suit your needs and environment.

Notification sound

Select the ringtone for notifications such as new messages receipt or calendar events.

Keyboard sound

Select whether to turn on/off the keyboard sound.

Touch sound

Allows you to set your tablet to play a sound when you touch buttons, icons and other onscreen items that react to your touch.

Screen lock sound

Allows you to set your tablet to play a sound when locking and unlocking the screen.

Notifications

Do not disturb

Allows you to set a schedule when to prevent interruptions from notifications. You can set to allow certain features to interrupt when Priority only is set.

Apps

Allows you to prevent apps from displaying notifications or set apps to show notifications with priority when Do not disturb is set to Priority only.

Lock screen

Allows you to choose if you want to show or hide notifications on the lock screen.

Display

Home screen

- **Select Home** – Select a Home screen mode.
- **Wallpaper** – Allows you to set the desired wallpaper for your Home screen.
- **Screen swipe effect** – Choose the desired type of effect to display when you swipe from one Home screen canvas to the next.
- **Icon shape** – Choose if you want icons to have square or rounded corners.
- **Sort apps by** – Sort apps by names or download date on the Home screen.
- **Hide apps** – Allows you to select apps to hide from the Home screen.
- **Continuous loop** – Enable to allow continuous Home screen scrolling (loop back to first screen after the last screen).
- **QuickMemo+ panel** – Activate to include an additional Home screen panel for writing a memo.

Lock screen

- **Select screen lock** – Allows you to set a screen lock to secure your device.
- **Smart Lock** – Set to keep your device unlocked when you have a trusted Bluetooth device connected to it, when it's in a familiar location like your home or work, when it recognizes your face or voice, or when it detects you're carrying it.
- **Wallpaper** – Select the wallpaper to display for your lock screen.
- **Clock** – Select the position of the clock on the lock screen.
- **Shortcuts** – Customize shortcuts on the lock screen.
- **Screen swipe effect** – Sets the effect used when swiping the lock screen.
- **Weather animation** – Enable to show weather animation on the lock screen for the current location.
- **Contact info for lost tablet** – Select whether to display the owner information on the lock screen and customize the owner information.
- **Lock timer** – Allows you to set the amount of time before the screen automatically locks after the screen has timed-out.
- **Power key instantly locks** – Set to instantly lock the screen when the Power/Lock Key is pressed. This setting overrides the Security lock timer setting.

Font type

Select the desired font type.

Font size

Select the desired font size.

Bold text

Bold the text on the screen.

Display size

Set the items on the screen to a size that is easy for you to see. Some items may change position.

Comfort view

Reduce the amount of blue light on the screen to reduce eye strain.

Brightness

Allows you to adjust the screen brightness.

Night brightness

Set brightness at 0% automatically between 12:00 AM ~ 06:00 AM.

Auto-rotate screen

Allows you to set to switch the screen orientation automatically when you physically rotate the device.

Screen timeout

Allows you to set the amount of time before the screen times out.

Home touch buttons

Allows you to set which Home touch buttons are displayed and their position on the bar. You can also select the color.

KnockON

Turn the screen on or off by tapping the screen twice.

Screen saver

Display a screen saver when the device is connected to the holder or charger. Select a screen saver type to display.

Smart Cleaning

Displays the space in use and free space in your tablet and allows you to selectively clean up your files.

Storage

DEVICE STORAGE

View the total storage space and free space in the device's internal storage. View a list of apps in use and the storage capacity for each app.

PORTABLE STORAGE

View the total storage space and free space in the memory card. This option appears only when a memory card is inserted. To unmount the memory card, tap .

Battery & Power Saving

BATTERY INFORMATION

The Battery charge information is displayed on a battery graphic along with the percentage of the remaining charge and its status.

Battery usage

Displays the battery usage level and battery use details. Tap one of the items to see more detailed information.

Battery percentage on status bar

Turn on to display the battery level percentage on the Status bar next to the battery icon.

Battery saver

Tap the Battery Saver switch  to toggle it On or Off. You can also set when to turn battery saver on.

Memory

You can monitor the memory used on average and the memory used by apps in the device.

Apps

Display the list of applications such as currently running or downloaded. Tap an entry to view more information, tap **Force stop** (or **Stop**), then **OK** to stop it from running.

PERSONAL

Users

This menu displays the current users you've created.

ADD USER

Allows you to add new account for the device and use the Multi-user feature.

Location

Turn on location service, your device determines your approximate location using Wi-Fi and mobile networks. When you select this option, you're asked whether you consent to allowing Google to use your location when providing these services.

- **Mode** – Sets the how your current location information is determined.
- **RECENT LOCATION REQUEST** – Displays applications and services that have recently requested your location.
- **Low power location estimation** – Estimate the device location by using low power consumption.
- **Google Location History** – Allows you to view and manage your Google location history.
- **Google Location Sharing** – Allows you to choose who can see where you are and for how long.

Security

Use the Security menu to configure how to help secure your device and its data.

Content lock

Allows you to lock files for the Gallery and memos for QuickMemo+. Choose from Password or Pattern.

Encrypt SD card

Encrypt SD card storage and keep data unavailable for other devices.

Secure start-up

When you power on your tablet, you will be required to enter your screen lock.

Set up SIM card lock

Lock or unlock the SIM card, or change the password (PIN).

Make passwords visible

Set to briefly show each character of passwords as you enter them so that you can see what you enter.

Tablet administrators

View or deactivate device administrators.

Unknown sources

Allow installation of non-Play Store applications.

Credential protection

Displays the storage type for credentials.

Certificate management

Allows you to manage your security certificates.

Trust agents

Select apps to use without unlocking the screen.

Screen pin

This feature allows you to lock your device so that the current user can only access the pinned app. This is useful for users with children.

Usage access

Allow this app to view usage info of apps on your device.

Accounts & Sync

Use the Accounts & sync settings menu to add, remove, and manage your Google and other supported accounts. You can also use these settings to control how and whether all applications send, receive, and sync data on their own schedules and whether all applications can synchronize user data automatically.

Gmail™, Calendar, and other applications may also have their own settings to control how they synchronize data; see the sections on those applications for details. Touch **ADD ACCOUNT** to add new account.

Language & Keyboard

Use the Language & keyboard settings to select the language for the text on your device and to configure the on-screen keyboard, including words you've added to its dictionary.

Backup & Reset

You can back up data saved on your device to another device or account. Reset the device, if necessary.

- **LG Mobile Switch:** Back up or restore the blocked sender list, messages, images, home screens and other data saved on the device. See *LG Mobile Switch* for details.
- **Backup & restore:** Back up your device data or restore data to your device from a backup.

- **Back up my data:** Back up your app data, Wi-Fi password and other settings to the Google server.
- **Backup account:** View the current backup account in use.
- **Automatic restore:** Automatically restore backup settings and data when reinstalling an app.
- **Network settings reset:** Reset Wi-Fi, Bluetooth and other network settings.
- **Factory data reset:** Reset all settings for the device and delete data.



- Resetting your device deletes all data on it. Enter your device name, Google account and other initial information again.

Google Services

Use this menu to manage your Google apps and account settings.

SYSTEM

QuickButton

Select the app you wish to get quick access to using QuickButton.

Shortcut Keys

Get quick access to apps by pressing the **Volume Keys** twice when the screen is off or locked.

- Press the **Volume Up Key** twice to open the Capture+ app.
- Press the **Volume Down Key** twice to launch the Camera app.

Date & Time

Use Date & time settings to set how dates will be displayed. You can also use these settings to set your own time and time zone rather than obtaining the current time from the mobile network.

Accessibility

Use the Accessibility settings to configure accessibility plug-ins you have installed on your device.

- **Vision** – Sets options for people with impaired sight.
 - **TalkBack** – Allows you to set up the TalkBack function which assists people with impaired vision by providing verbal feedback.
 - **Font size** – Sets the font size.
 - **Bold text** – Bold the text on the screen.
 - **Display size** – Set the items on the screen to a size that is easy for you to see. Some items may change position.
 - **Touch zoom** – Allows you to zoom in and out by triple-tapping the screen.
 - **Window zoom** – Zoom in or out within a window and invert the color.
 - **Large mouse pointer** – Magnify the mouse pointer.
 - **Screen color inversion** – Enable to invert the color of the screen and content.
 - **Screen color adjustment** – Allows you to adjust the color of screen and content.
 - **Grayscale** – Switch the screen to grayscale mode.
- **Hearing** – Sets options for people with impaired hearing.
 - **Captions** – Allows you to customize caption settings for those with hearing impairments.
 - **Mute all sounds** – Enable to turn off all device sounds.
 - **Audio channel** – Sets the audio type.
 - **Sound balance** – Sets the audio route. Move the slider on the slide bar to set it.
- **Motor & cognition** – Sets options for people with impaired motor skills.
 - **Touch assistant** – Show a touch board with easy access to common actions.

- **Touch input** – Enter text by touching and holding the screen or modify it by simply touching the screen.
- **Physical keyboard** – Customize the keyboard settings.
- **Auto mouse click** – Automatically click where the pointer stops.
- **Screen timeout** – Sets the amount of time before the backlight turns off automatically.
- **Touch control areas** – Allows you to select an area of the screen to limit touch activation to just that area of the screen.
- **Accessibility features shortcut** – Allows you to access selected features quickly when triple-tapping the Home button.
- **Auto-rotate screen** – Enable to allow the device to rotate the screen depending on the physical device orientation (portrait or landscape).
- **Switch Access** – Allows you to interact with your device using one or more switches that work like keyboard keys. This menu can be helpful for users with mobility limitations that prevent them from interacting directly with the your device.
- **Lookout**: Provide malware scanning, safe browsing, privacy advisor, missing device locator, and data backup.

About Tablet



This menu allows you to manage your software updates and view various information relating to your device.



Appendix

LG Language Settings

Select a language to use on your device.

- Tap  >  > **Language & keyboard** > **Language** > **ADD LANGUAGE**, and select a language.
 - Touch and hold  and drag it to the top of the language list to set it as a default language.

Software Update

Device Software Update

This feature allows you to update the firmware of your device to the latest version conveniently from the internet without the need to visit a service center.

For more information on how to use this function, please visit: <http://www.lg.com/common/index.jsp>.

As the device firmware update requires the user's full attention for the duration of the update process, please make sure to check all instructions and notes that appear at each step before proceeding. Please note that removing the USB cable during the upgrade may seriously damage your device.

LG Device Software Update via Over-the-Air (OTA)

This feature allows you to update the firmware of your device to the newer version conveniently via OTA without connecting the USB cable. This feature is only available if and when LG makes the newer version of the firmware available for your device.

First, you can check the software version on your device:

Tap  >  > **About tablet** > **Software info**.

To perform the device software update, tap  >  > **About tablet** > **Update center** > **System updates** > **CHECK FOR UPDATE**.



- Your personal data—including information about your Google account and any other accounts, your system/application data and settings, any downloaded applications and your DRM license –might be lost in the process of updating your device's software. Therefore, LG recommends that you back up your personal data before updating your device's software. LG does not take responsibility for any loss of personal data.

FAQ

This chapter lists some problems you might encounter when using your device. Some problems require you to call your service provider, but most are easy to fix yourself.

Message	Possible causes	Possible corrective measures
No applications can be set	Not supported by service provider or registration required.	Contact your service provider.
Charging error	Battery is not charged.	Charge battery.
	Outside temperature is too hot or cold.	Make sure device is charging at a normal temperature.
	Contact problem	Check the charger and its connection to the device.
	No voltage	Plug the charger into a different socket.
	Charger defective	Replace the charger.
	Wrong charger	Use only original LG accessories.
Impossible to receive / send photos	Memory full	Delete some images from your device.

Message	Possible causes	Possible corrective measures
Files do not open	Unsupported file format	Check the supported file formats.
No sound	Silent mode	Check the settings status in the sound menu to make sure you are not in silent mode.

Anti-Theft Guide

You can set up your device to prevent other people from using it if it's been reset to factory settings without your permission. For example, if your device is lost, stolen, or wiped, only someone with your Google account or screen lock information can use the device.

All you need to make sure your device is protected is:

- **Set a screen lock:** If your device is lost or stolen but you have a screen lock set, the device can't be erased using the Settings menu unless your screen is unlocked.
- **Add your Google account on your device:** If your device is wiped but you have your Google account on it, the device can't finish the setup process until your Google account information is entered again.

After your device is protected, you'll need to either unlock your screen or enter your Google account password if you need to do a factory reset. This ensures that you or someone you trust is doing the reset.



- Do not forget your Google account and password you had added to your device prior to performing a factory reset. If you can't provide the account information during the setup process, you won't be able to use the device at all after performing the factory reset.

More Information

Open Source Software Notice Information

To obtain the source code under GPL, LGPL, MPL, and other open source licenses, that is contained in this product, please visit <http://opensource.lge.com>.

In addition to the source code, all referred license terms, warranty disclaimers and copyright notices are available for download.

LG Electronics will also provide open source code to you on CD-ROM for a charge covering the cost of performing such distribution (such as the cost of media, shipping, and handling) upon email request to opensource@lge.com. This offer is valid for three (3) years from the date on which you purchased the product.

Trademarks

- LG and the LG logo are registered trademarks of LG Group and its related entities.
- Google™, Google Maps™, Gmail™, YouTube™, Hangouts™ and Play Store™ are trademarks of Google, Inc.
- Bluetooth® is a registered trademark of Bluetooth SIG, Inc. worldwide.
- Wi-Fi® and the Wi-Fi logo are registered trademarks of the Wi-Fi Alliance.
- All other trademarks and copyrights are the property of their respective owners.

If the Screen Freezes

If the screen freezes or the device does not respond when you try to operate it:

Press and hold the **Power/Lock Key + Volume Down Key** for about 10 seconds to reset your device. If it still does not work, please contact the service center.



For Your Safety

Important Information

This user guide contains important information on the use and operation of this device. Please read all the information carefully for optimal performance and to prevent any damage to or misuse of the device. Any changes or modifications not expressly approved in this user guide could void your warranty for this equipment. Any changes or modifications not expressly approved by the manufacturer could void the user's authority to operate the equipment.

Before You Start

WARNING: This product contains chemicals known to the State of California to cause cancer and birth defects or reproductive harm.

Wash hands after handling.

ELECTRICAL SAFETY

This product is intended for use when supplied with power from the designated battery or power supply unit. Other usage may be dangerous and will invalidate any approval given to this product.

SAFETY PRECAUTIONS FOR PROPER GROUNDING INSTALLATION

CAUTION: Connecting to improperly grounded equipment can result in an electric shock to your device. This product is equipped with a USB cable for connecting to a desktop or notebook computer. Be sure your computer is properly grounded (earthed) before connecting this product to the computer. The power supply cord of a desktop or notebook computer has an equipment-grounding conductor and a grounding plug.

The plug must be plugged into an appropriate outlet which is properly installed and grounded in accordance with all local codes and ordinances.

SAFETY PRECAUTIONS FOR POWER SUPPLY UNIT

Use the correct external power source

A product should be operated only from the type of power source indicated on the electrical ratings label. If you are not sure of the type of power source required, consult your authorized service provider or local power company. For a product that operates from battery power or other sources, refer to the operating instructions that are included with the product.

- Never place your tablet in a microwave oven as it will cause the battery to explode.
- Never store your tablet in temperatures less than -4°F or greater than 122°F.
- When riding in a car, do not leave your tablet or set up the hands-free kit near the air bag. If wireless equipment is improperly installed and the air bag is deployed, you may be seriously injured.
- Your tablet contains an internal battery. Do not dispose of your tablet near fire or with hazardous or flammable waste. You should dispose of your tablet in accordance with all applicable laws.
- Do not use the tablet in areas where its use is prohibited. (For example: aircraft)
- Do not expose the battery charger or adapter to direct sunlight or use it in places with high humidity, such as a bathroom.
- Do not use harsh chemicals (such as alcohol, benzene, thinners, etc.) or detergents to clean your tablet. This could cause a fire.
- Do not drop, strike, or shake your tablet severely. It may harm the internal circuit boards of the tablet.
- Do not use your tablet in high explosive areas as the tablet may generate sparks.
- Do not damage the power cord by bending, twisting, pulling, or heating. Do not use the plug if it is loose as it may cause electric shock or fire.
- Do not place any heavy items on the power cord. Do not allow the power cord to be crimped as it may cause electric shock or fire.
- Do not handle the tablet with wet hands while it is being charged. It may cause an electric shock or seriously damage your tablet.
- Do not disassemble the tablet.

- Do not attempt to repair or modify the device yourself. Your device is equipped with an internal rechargeable battery which should be replaced only by LG or an authorized LG repair center.
- You should never attempt to open or disassemble this device yourself and doing so may cause damage that voids your warranty.
- Make sure that no sharp-edged items, such as animal's teeth or claws, come into contact with the battery. This could cause a fire.
- Be careful that children do not swallow any parts (such as earphone, connection parts of the tablet, etc.) This could cause asphyxiation or suffocation resulting in serious injury or death.
- Unplug the power cord and charger during lightning storms to avoid electric shock or fire.
- Only use chargers provided by LG. The warranty will not be applied to products provided by other suppliers.
- Only authorized personnel should service the tablet and its accessories. Faulty installation or service may result in accidents and consequently invalidate the warranty.
- Your tablet is an electronic device that generates heat during normal operation. Extremely prolonged, direct skin contact in the absence of adequate ventilation may result in discomfort or minor burns. Therefore, use care when handling your tablet during or immediately after operation.

Safety Information

Please read and observe the following information for safe and proper use of your tablet and to prevent damage.

Caution

Violation of the instructions may cause minor or serious damage to the product.

- Do not disassemble or open crush, bend or deform, puncture or shred the device.
- Repairs under warranty, at LG's option, may include replacement parts or boards that are either new or reconditioned, provided that they have functionality equal to that of the parts being replaced.
- Do not modify or remanufacture, attempt to insert foreign objects into the battery, immerse or expose to water or other liquids, expose to fire, explosion or other hazard.
- Only use the battery for the device for which it is specified.
- Only use the device with an LG charging system that has been qualified with the device, per CTIA Certification Requirements for Battery System Compliance to IEEE1725. Use of an unqualified battery or charger may present a risk of fire, explosion, leakage, or other hazard.
- Do not short circuit a battery or allow metallic conductive objects to contact battery terminals.
- Replace the battery only with another battery that has been qualified with the system per this standard, IEEE-Std-1725. Use of an unqualified battery may present a risk of fire, explosion, leakage or other hazard. Only authorized service providers shall replace battery (If the battery is non-user replaceable).
- Battery usage by children should be supervised.
- Avoid dropping the tablet and the Plus Pack. If the tablet or the Plus Pack is dropped, especially on a hard surface, and the user suspects damage, take it to a service center for inspection.
- To dispose of the battery properly, call (800) 822-8837 or visit www.call2recycle.org.
- Always unplug the charger from the wall socket after the device is fully charged to save unnecessary power consumption.

- For those host devices that utilize a USB port as a charging source, the host device's user manual shall include a statement that the device shall only be connected to products that bear the USB-IF logo or have completed the USB-IF compliance program.

WARNING! Notice for Battery replacement

- For your safety, do not remove the battery incorporated in the product. If you need to replace the battery, take it to the nearest authorized LG Electronics service point or dealer for assistance.
- Li-Ion Battery is a hazardous component which can cause injury.
- Battery replacement by non-qualified professional can cause damage to your device.

Charger and Adapter Safety

- The charger and adapter are intended for indoor use only.
- Insert the battery pack charger vertically into the wall power socket.
- Unplug the power cord and charger during lightning storms to avoid electric shock or fire.
- Use the correct adapter for your tablet when using the battery pack charger abroad.

Battery Information and Care

- Always unplug the charger from the wall socket after the device is fully charged to save unnecessary power consumption of the charger.
- Please read the manual of specified charger about charging method.
- Do not damage the power cord by bending, twisting, or heating. Do not use the plug if it is loose as it may cause electric shock or fire.
Do not place any heavy items on the power cord. Do not allow the power cord to be crimped as it may cause electric shock or fire.
- Unplug the power cord prior to cleaning your tablet, and clean the power plug pin when it's dirty. When using the power plug, ensure that it's firmly connected. If not, it may cause excessive heat or fire. If you put your tablet in a pocket or bag without covering the receptacle of the tablet (power plug pin), metallic articles (such as a coin, paperclip or pen) may short-circuit the tablet. Short-circuit of the terminal may damage the battery and cause an explosion. Always cover the receptacle when not in use.

- Recharge the battery after long periods of non-use to maximize battery life. Battery life will vary due to usage pattern and environmental conditions.
- Never store your tablet in temperature less than -20°C/-4°F or greater than 50°C/122°F.
- Charging temperature range is between 0°C/32°F and 45°C/113°F. Do not charge the battery out of recommended temperature range. Charging out of recommended range might cause the generating heat or serious damage of battery. And also, it might cause the deterioration of battery's characteristics and cycle life.
- Do not use or leave the device under the blazing sun or in heated car by sunshine. The device may generate heat, smoke or flame. And also, it might cause the deterioration of battery's characteristics or cycle life.
- The battery back in the device has protection circuit to avoid the danger. Do not use near places that can generate static electricity more than 100V which could damage the protection circuit. Damaged protection circuits may generate smoke, rupture or ignite.
- When using the device for the first time, if it emits a bad smell, you see rust on it, or anything else abnormal, do not use the equipment and bring the battery to the shop which it was bought.
- Keep device away from babies and small children. If children use the battery, their parents or legal guardians are responsible for supervising and teaching them about the safe handling of device and how to use batteries according to the manual with care.
- If liquid from the battery in the device rubs against skin or clothing, wash with fresh water. It may cause the skin inflammation. Do not use the battery and take it to the nearest authorized LG Electronics service point or dealer for assistance. Be careful that children do not swallow any parts (such as earphone, connection parts of the device, etc.). This could cause asphyxiation or suffocation resulting in serious injury or death.
- Do not handle the tablet with wet hands while it is being charged. It may cause an electric shock or seriously damage your tablet.
- Do not use harsh chemicals (such as alcohol, benzene, thinners, etc.) or detergents to clean your tablet. This could cause a fire.

Care and Maintenance

Your mobile device is a product of superior design and craftsmanship and should be treated with care. The suggestions below will help you fulfill any warranty obligations and allow you to enjoy this product for many years:

Keep your Mobile Device away from: Liquids of any kind

Keep the mobile device dry. Precipitation, humidity, and liquids contain minerals that will corrode electronic circuits. If the mobile device does get wet, do not accelerate drying with the use of an oven, microwave, or dryer, because this may damage the mobile device and could cause a fire or explosion.

Do not use the mobile device with a wet hand.

Doing so may cause an electric shock to you or damage to the mobile device.

Please ensure that the product does not get in contact with liquid. Do not use or recharge the product if it is wet. Once the product becomes wet, the liquid damage indicator changes color. Please note that this will limit you from receiving any free-of-charge repair services provided under warranty.

Extreme heat or cold

- Avoid temperatures below 0°C/32°F or above 45°C/113°F.
- Use your tablet in temperatures between 0°C/32°F and 40°C/104°F, if possible. Exposing your tablet to extremely low or high temperatures may result in damage, malfunction, or even explosion.

Microwaves

Do not try to dry your mobile device in a microwave oven. Doing so may cause a fire or explosion.

Dust and dirt

Do not expose your mobile device to dust, dirt, or sand.

Sunscreen lotion

Do not expose or wear your device to any liquid like sunscreen lotion.

Doing so may cause your device to or damage to the mobile device.

Cleaning solutions

Do not use harsh chemicals, cleaning solvents, or strong detergents to clean the mobile device.

Wipe it with a soft cloths lightly dampened in a mild soap-and-water solution.

Shock or vibration

Do not drop, knock, or shake the mobile device.

Rough handling can break internal circuit boards.

Paint

Do not paint the mobile device. Paint can clog the device's moving parts or ventilation openings and prevent proper operation.

General Notice

- Do not place items containing magnetic components such as a credit card, phone card, bank book, or subway ticket near your device. The magnetism of the device may damage the data stored in the magnetic strip.
- When the tablet is not used for a long period time, store it in a safe place with the power cord unplugged.
- The data saved in your tablet might be deleted due to careless use, repair of the tablet, or upgrade of the software. Please backup your important contacts. (pictures, and videos could also be deleted.) The manufacturer is not liable for damage due to the loss of data.
- When you use the tablet in public places, set the sound profile to silent so you don't disturb others.
- Do not turn your tablet on or off when putting it to your ear.
- Your device is an electronic device that generates heat during normal operation. Extremely prolonged, direct skin contact in the absence of adequate ventilation may result in discomfort or minor burns. Therefore, use care when handling your device during or immediately after operation.
- Use accessories, such as earphones and headsets, with caution. Ensure that cables are tucked away safely and do not touch the antenna unnecessarily.

Part 15.19 Statement

This device complies with part 15 of FCC rules.

Operation is subject to the following two conditions:

(1) This device may not cause harmful interference, and (2) this device must accept any interference received, including interference that causes undesired operation.

Part 15.21 Statement

Any changes or modifications not expressly approved by the manufacturer could void the user's authority to operate the equipment.

Part 15.105 Statement

This equipment has been tested and found to comply with the limits for a class B digital device, pursuant to Part 15 of the FCC Rules. These limits are designed to provide reasonable protection against harmful interference in a residential installation. This equipment generates uses and can radiate radio frequency energy and, if not installed and used in accordance with the instructions, may cause harmful interference to radio communications. However, there is no guarantee that interference will not occur in a particular installation. If this equipment does cause harmful interference or television reception, which can be determined by turning the equipment off and on, the user is encouraged to try to correct the interference by one or more of the following measures:

- Reorient or relocate the receiving antenna.
- Increase the separation between the equipment and receiver.
- Connect the equipment into an outlet on a circuit different from that to which the receiver is connected.
- Consult the dealer or an experienced radio/TV technician for help.

FCC RF Exposure Information

WARNING! Read this information before operating the device.

In August 1996, the Federal Communications Commission (FCC) of the United States, with its action in Report and Order FCC 96-326, adopted an updated safety standard for human exposure to Radio Frequency (RF) electromagnetic energy emitted by FCC regulated transmitters. Those guidelines are consistent with the safety standard previously set by both U.S. and international standards bodies. The design of this device complies with the FCC guidelines and these international standards.

Bodily Contact During Operation

This device was tested for typical use with the back of the device kept 0 inch (0 cm) from the body.

Consumer Information about Radio Frequency Emissions

Your wireless device, which contains a radio transmitter and receiver, emits radio frequency energy during use. The following consumer information addresses commonly asked questions about the health effects of wireless devices.

Are wireless devices safe?

Scientific research on the subject of wireless devices and radio frequency ("RF") energy has been conducted worldwide for many years, and continues. In the United States, the Food and Drug Administration ("FDA") and the Federal Communications Commission ("FCC") set policies and procedures for wireless devices. The FDA issued a website publication on health issues related to device usage where it states, The scientific community at large ... believes that the weight of scientific evidence does not show an association between exposure to radiofrequency (RF) from the devices and adverse health outcomes. Still the scientific community does recommend conducting additional research to address gaps in knowledge. That research is being conducted around the world and FDA continues to monitor developments in this field. You can access the joint FDA/FCC website at <http://www.fda.gov> (under "C" in the subject index, select Cell Phones > Research). You can also contact the FDA toll-free at (888) 463-6332 or (888) INFO-FDA. In June 2000, the FDA entered into a cooperative research and development agreement through which additional scientific research is being conducted. The FCC issued its own website publication stating that "there is no scientific evidence that proves that wireless device usage can lead to cancer or a variety of other problems, including headaches, dizziness or memory loss".

This publication is available at <http://www.fcc.gov/oet/rfsafety> or through the FCC at (888) 225-5322 or (888) CALL-FCC.

What does "SAR" mean?

In 1996, the FCC, working with the FDA, the U.S. Environmental Protection Agency, and other agencies, established RF exposure safety guidelines for wireless devices in the United States. Before a wireless device model is available for sale to the

public, it must be tested by the manufacturer and certified to the FCC that it does not exceed limits established by the FCC. One of these limits is expressed as a Specific Absorption Rate, or "SAR." SAR is a measure of the rate of absorption of RF energy in the body. Tests for SAR are conducted with the device transmitting at its highest power level in all tested frequency bands. Since 1996, the FCC has required that the SAR of handheld wireless device not exceed 1.6 watts per kilogram, averaged over one gram of tissue.

Although the SAR is determined at the highest power level, the actual SAR value of a wireless device while operating can be less than the reported SAR value. This is because the SAR value may vary from call to call, depending on factors such as proximity to a cell site, the proximity of the device to the body while in use, and the use of hands-free devices. Before a device model is available for sale to the public, it must be tested and certified to the FCC that it does not exceed the limit established by the government-adopted requirement for safe exposure. The tests are performed in positions and locations (e.g., at the ear and worn on the body) as required by the FCC for each model.

The FCC has granted an Equipment Authorization for this model device with all reported SAR levels evaluated as in compliance with the FCC RF emission guidelines. SAR information on this model device is on file with the FCC and can be found under the Display Grant section of <http://www.fcc.gov/oet/ea/fccid/> after searching on FCC ID ZNFV530.

For more information about SARs, visit the FCC website at <https://www.fcc.gov/consumers/guides/specific-absorption-rate-sar-cell-phones-what-it-means-you>. You may also wish to contact the manufacturer of your device.

Can I minimize my RF exposure?

If you are concerned about RF, there are several simple steps you can take to minimize your RF exposure. You can, of course, reduce your talk time. You can place more distance between your body and the source of the RF, as the exposure level drops off dramatically with distance. The FDA/FCC website states that "hands-free kits can be used with wireless devices for convenience and comfort. These systems reduce the absorption of RF energy in the head because the device, which is the source of the RF emissions, will not be placed against the head. On the other hand, if the device is mounted against the waist or other part of the body during use, then that part of the body will absorb more RF energy. Wireless devices marketed in the U.S. are required to meet safety requirements regardless of whether they are used against the head or against the body. Either configuration should result in compliance with the safety limit." Also, if you use your wireless device while in a

car, you can use a device with an antenna on the outside of the vehicle. You should also read and follow your wireless device manufacturer's instructions for the safe operation of your device.

Do wireless devices pose any special risks to children?

The FDA/FCC website states that "the scientific evidence does not show a danger to users of wireless communication devices, including children." The FDA/FCC website further states that "some groups sponsored by other national governments have advised that children be discouraged from using wireless device at all." For example, the Stewart Report from the United Kingdom ["UK"] made such a recommendation in December 2000. In this report a group of independent experts noted that no evidence exists that using a device causes brain tumors or other ill effects. [The UK's] recommendation to limit device use by children was strictly precautionary; it was not based on scientific evidence that any health hazard exists. A copy of the UK's leaflet is available at <http://www.dh.gov.uk> (search "mobile"), or you can write to: NRPB, Chilton, Didcot, Oxon OX11 0RQ, United Kingdom. Copies of the UK's annual reports on mobile device and RF are available online at <http://www.hpa.org.uk/radiation/> (search "mobile"). Parents who wish to reduce their children's RF exposure may choose to restrict their children's wireless device use.

Where can I get further information about RF emissions?

For further information, see the following additional resources (websites current as of April 2005):

U.S. Food and Drug Administration

FDA Consumer magazine

November-December 2000

Telephone: (888) INFO-FDA

<http://www.fda.gov>

(Under "C" in the subject index, select Cell Phones > Research.)

U.S. Federal Communications Commission

445 12th Street, S.W.

Washington, D.C. 20554

Telephone: (888) 225-5322

<http://www.fcc.gov/oet/rfsafety>

Royal Society of Canada Expert Panels on Potential Health Risks of Radio Frequency Fields from Wireless Telecommunication Devices

283 Sparks Street

Ottawa, Ontario K1R 7X9

Canada

Telephone: (613) 991-6990

World Health Organization

Avenue Appia 20

1211 Geneva 27

Switzerland

Telephone: 011 41 22 791 21 11

<http://www.who.int/mediacentre/factsheets/fs193/en/>

International Commission on Non-Ionizing Radiation Protection

c/o Bundesamt für Strahlenschutz

Ingolstaedter Landstr. 1

85764 Oberschleissheim

Germany

Telephone: 011 49 1888 333 2156

<http://www.icnirp.de>

Engineering in Medicine and Biology Society, Committee on Man and Radiation (COMAR) of the Institute of Electrical and Electronics Engineers

<http://ewh.ieee.org/soc/embs/comar/>

Consumer Information on SAR

(Specific Absorption Rate)

This model device meets the government's requirements for exposure to radio waves.

Your wireless device is a radio transmitter and receiver. It is designed and manufactured not to exceed the emission limits for exposure to Radio Frequency (RF) energy set by the Federal Communications Commission of the U.S.

Government. These limits are part of comprehensive guidelines and establish permitted levels of RF energy for the general population. The guidelines are based on standards that were developed by independent scientific organizations through periodic and thorough evaluation of scientific studies. The standards include a substantial safety margin designed to assure the safety of all persons, regardless of age and health.

The exposure standard for wireless mobile devices employs a unit of measurement known as the Specific Absorption Rate, or SAR. The SAR limit set by the FCC is 1.6W/kg.

Tests for SAR are conducted using standard operating positions specified by the FCC with the device transmitting at its highest certified power level in all tested frequency bands. Although SAR is determined at the highest certified power level, the actual SAR level of the device while operating can be well below the maximum value. Because the device is designed to operate at multiple power levels to use only the power required to reach the network, in general, the closer you are to a wireless base station antenna, the lower the power output.

Before a device model is available for sale to the public, it must be tested and certified to the FCC that it does not exceed the limit established by the government-adopted requirement for safe exposure. The tests are performed in positions and locations (e.g., at the ear and worn on the body) as required by the FCC for each model.

The highest SAR value for this device when worn on the body, as described in this user guide, is 1.07W/kg (1g, 0mm) (body-worn measurements differ among device models, depending upon available accessories and FCC requirements). While there may be differences between SAR levels of various devices and at various positions, they all meet the government requirement for safe exposure.

The FCC has granted an Equipment Authorization for this model device with all reported SAR levels evaluated as in compliance with the FCC RF emission guidelines. SAR information on this model device is on file with the FCC and can be found under the Display Grant section of <http://www.fcc.gov/oet/fccid> after

searching on FCC ID ZNFV530. Additional information on Specific Absorption Rates (SAR) can be found on the Cellular Telecommunications Industry Association (CTIA) website at <http://www.ctia.org/>.

* In the United States and Canada, the SAR limit for mobile device used by the public is 1.6 watts/kg (W/kg) averaged over one gram of tissue. The standard incorporates a substantial margin of safety to give additional protection for the public and to account for any variations in measurements.

Caution: Avoid potential hearing loss.

Prolonged exposure to loud sounds (including music) is the most common cause of preventable hearing loss. Some scientific research suggests that using portable audio devices, such as portable music players and cellular telephones, at high volume settings for long durations may lead to permanent noise-induced hearing loss. This includes the use of headphones (including headsets, earbuds and Bluetooth® or other wireless devices). Exposure to very loud sound has also been associated in some studies with tinnitus (a ringing in the ear), hypersensitivity to sound and distorted hearing. Individual susceptibility to noise-induced hearing loss and other potential hearing problems varies. The amount of sound produced by a portable audio device varies depending on the nature of the sound, the device, the device settings and the headphones. You should follow some commonsense recommendations when using any portable audio device:

- Set the volume in a quiet environment and select the lowest volume at which you can hear adequately.
- When using headphones, turn the volume down if you cannot hear the people speaking near you or if the person sitting next to you can hear what you are listening to.
- Do not turn the volume up to block out noisy surroundings. If you choose to listen to your portable device in a noisy environment, use noise-cancelling headphones to block out background environmental noise.
- Limit the amount of time you listen. As the volume increases, less time is required before your hearing could be affected.
- Avoid using headphones after exposure to extremely loud noises, such as rock concerts, that might cause temporary hearing loss. Temporary hearing loss might cause unsafe volumes to sound normal.

- Do not listen at any volume that causes you discomfort. If you experience ringing in your ears, hear muffled speech or experience any temporary hearing difficulty after listening to your portable audio device, discontinue use and consult your doctor.

You can obtain additional information on this subject from the following sources:

Safety 205

American Academy of Audiology 11730
Plaza American Drive, Suite 300
Reston, VA 20190

Voice: (800) 222-2336

Email: info@audiology.org

Internet: www.audiology.org

National Institute on Deafness and Other Communication
Disorders

National Institutes of Health

31 Center Drive, MSC 2320

Bethesda, MD USA 20892-2320

Voice: (301) 496-7243

Email: nidcdinfo@nih.gov

Internet: <http://www.nidcd.nih.gov/health/hearing>

National Institute for Occupational Safety and Health Hubert H. Humphrey Bldg.

200 Independence Ave., SW Washington, DC 20201 Voice:

1-800-35-NIOSH (1-800-356-4674)

Internet: <http://www.cdc.gov/niosh/topics/noise/default.html>

TIA Safety Information

The following is the complete TIA Safety Information for wireless handheld devices.

Exposure to Radio Frequency Signal

Your wireless handheld portable device is a low power radio transmitter and receiver. When ON, it receives and sends out Radio Frequency (RF) signals.

In August, 1996, the Federal Communications Commissions (FCC) adopted RF exposure guidelines with safety levels for handheld wireless devices. Those guidelines are consistent with the safety standards previously set by both U.S. and international standards bodies:

ANSI C95.1 (1992) *

NCRP Report 86 (1986)

ICNIRP (1996)

* American National Standards Institute; National Council on Radiation Protection and Measurements; International Commission on Non-Ionizing Radiation Protection

Those standards were based on comprehensive and periodic evaluations of the relevant scientific literature. For example, over 120 scientists, engineers, and physicians from universities, government health agencies, and industry reviewed the available body of research to develop the ANSI Standard (C95.1).

The design of your device complies with the FCC guidelines (and those standards).

Tips on Efficient Operation

For your device to operate most efficiently:

Don't touch the antenna unnecessarily when the tablet is in use. Contact with the antenna affects call quality and may cause the tablet to operate at a higher power level than otherwise needed.

Electronic Devices

Most modern electronic equipment is shielded from RF signals. However, certain electronic equipment may not be shielded against the RF signals from your wireless device.

Pacemakers

The Health Industry Manufacturers Association recommends that a minimum separation of six (6) inches be maintained between a handheld wireless device and a pacemaker to avoid potential interference with the pacemaker. These recommendations are consistent with the independent research by and recommendations of Wireless Technology Research.

Persons with pacemakers:

- Should ALWAYS keep the device more than six (6) inches from their pacemaker when the device is turned ON;
- Should not carry the device in a breast pocket;
- Should use the ear opposite the pacemaker to minimize the potential for interference;
- Should turn the tablet OFF immediately if there is any reason to suspect that interference is taking place.

Hearing Aids

Some digital wireless device may interfere with some hearing aids. In the event of such interference, you may want to consult your service provider (or call the customer service line to discuss alternatives).

Other Medical Devices

If you use any other personal medical device, consult the manufacturer of your device to determine if it is adequately shielded from external RF energy. Your physician may be able to assist you in obtaining this information.

Health Care Facilities

Turn your device OFF in health care facilities when any regulations posted in these areas instruct you to do so. Hospitals or health care facilities may use equipment that could be sensitive to external RF energy.

Vehicles

RF signals may affect improperly installed or inadequately shielded electronic systems in motor vehicles. Check with the manufacturer or its representative regarding your vehicle. You should also consult the manufacturer of any equipment that has been added to your vehicle.

Posted Facilities

Turn your device OFF in any facility where posted notices so require.

Aircraft

FCC regulations prohibit using your device while in the air. Switch OFF your tablet before boarding an aircraft.

Blasting Areas

To avoid interfering with blasting operations, turn your device OFF when in a “blasting area” or in areas posted: “Turn off two-way radio”. Obey all signs and instructions.

Potentially Explosive Atmosphere

Turn your device OFF when in any area with a potentially explosive atmosphere and obey all signs and instructions. Sparks in such areas could cause an explosion or fire resulting in bodily injury or even death.

Areas with a potentially explosive atmosphere are often, but not always marked clearly. Potential areas may include: fueling areas (such as gasoline stations); below deck on boats; fuel or chemical transfer or storage facilities; vehicles using liquefied petroleum gas (such as propane or butane); areas where the air contains chemicals or particles (such as grain, dust, or metal powders); and any other area where you would normally be advised to turn off your vehicle engine.

For Vehicles Equipped with an Air Bag

An air bag inflates with great force. DO NOT place objects, including either installed or portable wireless equipment, in the area over the air bag or in the air bag deployment area. If in-vehicle wireless equipment is improperly installed and the air bag inflates, serious injury could result.

FDA Consumer Update



The U.S. Food and Drug Administration's Center for Devices and Radiological Health Consumer Update on Mobile Tablets:

1. Do tablets pose a health hazard?

The available scientific evidence does not show that any health problems are associated with using tablets.

There is no proof, however, that tablets are absolutely safe. Tablets emit low levels of Radio Frequency (RF) energy in the microwave range while being used. They also emit very low levels of RF when in idle mode. Whereas high levels of RF can produce health effects (by heating tissue), exposure to low level RF that does not produce heating effects causes no known adverse health effects. Many studies of low level RF exposures have not found any biological effects. Some studies have suggested that some biological effects may occur, but such findings have not been confirmed by additional research. In some cases, other researchers have had difficulty in reproducing those studies, or in determining the reasons for inconsistent results.

2. What is the FDA's role concerning the safety of tablets?

Under the law, the FDA does not review the safety of radiation-emitting consumer products such as tablets before they can be sold, as it does with new drugs or medical devices. However, the agency has authority to take action if tablets are shown to emit Radio Frequency (RF) energy at a level that is hazardous to the user. In such a case, the FDA could require the manufacturers of tablets to notify users of the health hazard and to repair, replace, or recall the tablets so that the hazard no longer exists.

Although the existing scientific data does not justify FDA regulatory actions, the FDA has urged the tablet industry to take a number of steps, including the following:

- Support needed research into possible biological effects of RF of the type emitted by tablets;
- Design tablets in a way that minimizes any RF exposure to the user that is not necessary for device function; and
- Cooperate in providing users of tablets with the best possible information on possible effects of tablet use on human health.

The FDA belongs to an interagency working group of the federal agencies that have responsibility for different aspects of RF safety to ensure coordinated efforts at the federal level. The following agencies belong to this working group:

- National Institute for Occupational Safety and Health
- Environmental Protection Agency
- Occupational Safety and Health Administration
- National Telecommunications and Information Administration

The National Institutes of Health participates in some interagency working group activities, as well.

The FDA shares regulatory responsibilities for tablets with the Federal Communications Commission (FCC). All tablets that are sold in the United States must comply with FCC safety guidelines that limit RF exposure. The FCC relies on the FDA and other health agencies for safety questions about tablets.

The FCC also regulates the base stations that the tablet networks rely upon. While these base stations operate at higher power than do the tablets themselves, the RF exposures that people get from these base stations are typically thousands of times lower than those they can get from tablets. Base stations are thus not the subject of the safety questions discussed in this document.

3. What kinds of devices are the subject of this update?

The term “wireless device” refers here to handheld wireless devices with built-in antennas, often called “cell”, “mobile”, or “PCS” devices. These types of wireless devices can expose the user to measurable Radio Frequency (RF) energy because of the short distance between the device and the user’s head.

These RF exposures are limited by FCC safety guidelines that were developed with the advice of the FDA and other federal health and safety agencies. When the device is located at greater distances from the user, the exposure to RF is drastically lower because a person’s RF exposure decreases rapidly with increasing distance from the source.

4. What are the results of the research done already?

The research done thus far has produced conflicting results, and many studies have suffered from flaws in their research methods. Animal experiments investigating the effects of Radio Frequency (RF) energy exposures characteristic of wireless devices have yielded conflicting results that often cannot be repeated in other laboratories. A few animal studies, however, have suggested that low levels of RF could accelerate the development of cancer in laboratory animals. However, many

of the studies that showed increased tumor development used animals that had been genetically engineered or treated with cancer-causing chemicals so as to be pre-disposed to develop cancer in the absence of RF exposure. Other studies exposed the animals to RF for up to 22 hours per day. These conditions are not similar to the conditions under which people use wireless devices, so we do not know with certainty what the results of such studies mean for human health. Three large epidemiology studies have been published since December 2000. Between them, the studies investigated any possible association between the use of wireless devices and primary brain cancer, glioma, meningioma, or acoustic neuroma, tumors of the brain or salivary gland, leukemia, or other cancers. None of the studies demonstrated the existence of any harmful health effects from wireless device RF exposures. However, none of the studies can answer questions about long-term exposures, since the average period of device use in these studies was around three years.

5. What research is needed to decide whether RF exposure from tablets poses a health risk?

A combination of laboratory studies and epidemiological studies of people actually using tablets would provide some of the data that are needed. Lifetime animal exposure studies could be completed in a few years. However, very large numbers of animals would be needed to provide reliable proof of a cancer promoting effect if one exists. Epidemiological studies can provide data that is directly applicable to human populations, but ten or more years follow-up may be needed to provide answers about some health effects, such as cancer. This is because the interval between the time of exposure to a cancer-causing agent and the time tumors develop – if they do – may be many, many years. The interpretation of epidemiological studies is hampered by difficulties in measuring actual RF exposure during day-to-day use of tablets. Many factors affect this measurement, such as the angle at which the tablet is held, or which model of tablet is used.

6. What is the FDA doing to find out more about the possible health effects of tablet RF?

The FDA is working with the U.S. National Toxicology Program and with groups of investigators around the world to ensure that high priority animal studies are conducted to address important questions about the effects of exposure to Radio Frequency (RF) energy.

The FDA has been a leading participant in the World Health Organization International Electro Magnetic Fields (EMF) Project since its inception in 1996. An influential result of this work has been the development of a detailed agenda

of research needs that has driven the establishment of new research programs around the world. The project has also helped develop a series of public information documents on EMF issues.

The FDA and the Cellular Telecommunications & Internet Association (CTIA) have a formal Cooperative Research And Development Agreement (CRADA) to do research on wireless device safety. The FDA provides the scientific oversight, obtaining input from experts in government, industry, and academic organizations. CTIA-funded research is conducted through contracts with independent investigators. The initial research will include both laboratory studies and studies of wireless device users. The CRADA will also include a broad assessment of additional research needs in the context of the latest research developments around the world.

7. How can I find out how much Radio Frequency energy exposure I can get by using my tablet?

All tablets sold in the United States must comply with Federal Communications Commission (FCC) guidelines that limit Radio Frequency (RF) energy exposures. The FCC established these guidelines in consultation with the FDA and the other federal health and safety agencies. The FCC limit for RF exposure from wireless devices is set at a Specific Absorption Rate (SAR) of 1.6 watts per kilogram (1.6 W/kg). The FCC limit is consistent with the safety standards developed by the Institute of Electrical and Electronic Engineering (IEEE) and the National Council on Radiation Protection and Measurement. The exposure limit takes into consideration the body's ability to remove heat from the tissues that absorb energy from the tablet and is set well below levels known to have effects. Manufacturers of tablets must report the RF exposure level for each model of tablet to the FCC. The FCC website (<http://www.fcc.gov/oet/rfsafety>) gives directions for locating the FCC identification number on your tablet so you can find your tablet's RF exposure level in the online listing.

8. What has the FDA done to measure the Radio Frequency energy coming from tablets?

The Institute of Electrical and Electronic Engineers (IEEE) is developing a technical standard for measuring the Radio Frequency (RF) energy exposure from tablets and other wireless handsets with the participation and leadership of FDA scientists and engineers. The standard, "Recommended Practice for Determining the Spatial-Peak Specific Absorption Rate (SAR) in the Human Body Due to Wireless Communications Devices: Experimental Techniques", sets forth the first consistent test methodology for measuring the rate at which RF is deposited in the heads

and bodies of tablet users. The test method uses a tissue-simulating model of the human head and body. Standardized SAR test methodology is expected to greatly improve the consistency of measurements made at different laboratories on the same tablet. SAR is the measurement of the amount of energy absorbed in tissue, either by the whole body or a small part of the body. It is measured in watts/kg (or milliwatts/g) of matter. This measurement is used to determine whether a tablet complies with safety guidelines.

9. What steps can I take to reduce my exposure to Radio Frequency energy from my tablet?

If there is a risk from these products – and at this point we do not know that there is – it is probably very small. But if you are concerned about avoiding even potential risks, you can take a few simple steps to minimize your exposure to Radio Frequency (RF) energy. Since time is a key factor in how much exposure a person receives, reducing the amount of time spent using a tablet will reduce RF exposure. If you must conduct extended conversations using a wireless device every day, you could place more distance between your body and the source of the RF, since the exposure level drops off dramatically with distance. For example, you could use a headset and carry the tablet away from your body or use a wireless device connected to a remote antenna. Again, the scientific data does not demonstrate that tablets are harmful. But if you are concerned about the RF exposure from these products, you can use measures like those described above to reduce your RF exposure from tablet use.

10. What about children using tablets?

The scientific evidence does not show a danger to users of tablets, including children and teenagers. If you want to take steps to lower exposure to Radio Frequency (RF) energy, the measures described above would apply to children and teenagers using tablets. Reducing the time of tablet use and increasing the distance between the user and the RF source will reduce RF exposure.

Some groups sponsored by other national governments have advised that children be discouraged from using wireless devices at all. For example, the government in the United Kingdom distributed leaflets containing such a recommendation in December 2000. They noted that no evidence exists that using a wireless device causes brain tumors or other ill effects. Their recommendation to limit wireless device use by children was strictly precautionary; it was not based on scientific evidence that any health hazard exists.

11. What about wireless communications device interference with medical equipment?

Radio Frequency (RF) energy from wireless communications devices can interact with some electronic devices. For this reason, the FDA helped develop a detailed test method to measure Electro Magnetic Interference (EMI) of implanted cardiac pacemakers and defibrillators from wireless devices. This test method is now part of a standard sponsored by the Association for the Advancement of Medical Instrumentation (AAMI). The final draft, a joint effort by the FDA, medical device manufacturers, and many other groups, was completed in late 2000. This standard will allow manufacturers to ensure that cardiac pacemakers and defibrillators are safe from wireless communications device EMI.

The FDA has tested hearing aids for interference from handheld wireless devices and helped develop a voluntary standard sponsored by the Institute of Electrical and Electronic Engineers (IEEE). This standard specifies test methods and performance requirements for hearing aids and wireless communications devices so that no interference occurs when a person uses a “compatible” device and a “compatible” hearing aid at the same time. This standard was approved by the IEEE in 2000.

The FDA continues to monitor the use of wireless communications devices for possible interactions with other medical devices. Should harmful interference be found to occur, the FDA will conduct testing to assess the interference and work to resolve the problem.

The FDA continues to monitor the use of wireless devices for possible interactions with other medical devices. Should harmful interference be found to occur, the FDA will conduct testing to assess the interference and work to resolve the problem.

12. Where can I find additional information?

For additional information, please refer to the following resources:

Federal Communications Commission (FCC) RF Safety Program
(<http://www.fcc.gov/oet/rfsafety>)

International Commission on Non-Ionizing Radiation Protection
(<http://www.icnirp.de>)

World Health Organization (WHO) International EMF Project
(<http://www.who.int/emf>)

National Radiological Protection Board (UK)
(<http://www.hpa.org.uk/radiation/>)

Driving

Check the laws and regulations on the use of wireless devices in the areas where you drive and always obey them. Also, if using your device while driving, please observe the following:

- Give full attention to driving -- driving safely is your first responsibility;
- Use hands-free operation, if available;
- Pull off the road and park before using it.

10 Driver Safety Tips

Your wireless phone gives you the powerful ability to communicate by voice almost anywhere, anytime. An important responsibility accompanies the benefits of wireless phones, one that every user must uphold.

When operating a car, driving is your first responsibility. When using your wireless phone behind the wheel of a car, practice good common sense and remember the following tips:

1. Get to know your wireless phone and its features such as speed dial and redial. Carefully read your instruction manual and learn to take advantage of valuable features most phones offer, including automatic redial and memory. Also, work to memorize the phone keypad so you can use the speed dial function without taking your attention off the road.
2. When available, use a hands-free device. A number of hands-free wireless phone accessories are readily available today. Whether you choose an installed mounted device for your wireless phone or a speaker phone accessory, take advantage of these devices if available to you.
3. Make sure you place your wireless phone within easy reach and where you can reach it without removing your eyes from the road. If you get an incoming call at an inconvenient time, if possible, let your voicemail answer it for you.
4. Suspend conversations during hazardous driving conditions or situations. Let the person you are speaking with know you are driving; if necessary, suspend the call in heavy traffic or hazardous weather conditions. Rain, sleet, snow, and ice can be hazardous, but so is heavy traffic. As a driver, your first responsibility is to pay attention to the road.
5. Don't take notes or look up phone numbers while driving. If you are reading an address book or business card, or writing a "to-do" list while driving a car, you are not watching where you are going. It is common sense. Do not get caught in a dangerous situation because you are reading or writing and not paying attention

to the road or nearby vehicles.

6. Dial sensibly and assess the traffic; if possible, place calls when you are not moving or before pulling into traffic. Try to plan your calls before you begin your trip or attempt to coincide your calls with times you may be stopped at a stop sign, red light, or otherwise stationary. But if you need to dial while driving, follow this simple tip -- dial only a few numbers, check the road and your mirrors, then continue.
7. Do not engage in stressful or emotional conversations that may be distracting. Stressful or emotional conversations and driving do not mix; they are distracting and even dangerous when you are behind the wheel of a car. Make people you are talking with aware you are driving and if necessary, suspend conversations which have the potential to divert your attention from the road.
8. Use your wireless phone to call for help. Your wireless phone is one of the greatest tools you can own to protect yourself and your family in dangerous situations -- with your phone at your side, help is only three numbers away. Dial 911 or other local emergency number in the case of fire, traffic accident, road hazard, or medical emergency. Remember, it's a free call on your wireless phone!
9. Use your wireless phone to help others in emergencies. Your wireless phone provides you a perfect opportunity to be a "Good Samaritan" in your community. If you see an auto accident, crime in progress or other serious emergency where lives are in danger, call 911 or other local emergency number, as you would want others to do for you.
10. Call roadside assistance or a special wireless non-emergency assistance number when necessary. Certain situations you encounter while driving may require attention, but are not urgent enough to merit a call for emergency services. But you can still use your wireless phone to lend a hand. If you see a broken-down vehicle posing no serious hazard, a broken traffic signal, a minor traffic accident where no one appears injured or a vehicle you know to be stolen, call roadside assistance or other special non-emergency wireless number.

The above tips are meant as general guidelines. Before deciding to use your mobile device while operating a vehicle, it is recommended that you consult your applicable jurisdiction's local laws or other regulations regarding such use. Such laws or other regulations may prohibit or otherwise restrict the manner in which a driver may use his or her phone while operating a vehicle.



**LIMITED
WARRANTY
STATEMENT**

ARBITRATION NOTICE: THIS LIMITED WARRANTY CONTAINS AN ARBITRATION PROVISION THAT REQUIRES YOU AND LG TO RESOLVE DISPUTES BY BINDING ARBITRATION INSTEAD OF IN COURT, UNLESS YOU CHOOSE TO OPT OUT. IN ARBITRATION, CLASS ACTIONS AND JURY TRIALS ARE NOT PERMITTED. PLEASE SEE THE SECTION TITLED "PROCEDURE FOR RESOLVING DISPUTES" BELOW.

Warranty Laws

The following laws govern warranties that arise in retail sales of consumer goods:

- The California Song-Beverly Consumer Warranty Act [CC §§1790 et seq],
- The California Uniform Commercial Code, Division Two [Com C §§2101 et seq], and
- The federal Magnuson-Moss Warranty Federal Trade Commission Improvement Act [15 USC §§2301 et seq; 16 CFR Parts 701 – 703]. A typical Magnuson-Moss Act warranty is a written promise that the product is free of defects or a written promise to refund, repair, or replace defective goods. [See 15 USC §2301(6).] Remedies include damages for failing to honor a written warranty or service contract or for violating disclosure provisions. [See 15 USC §2310(d).] Except for some labeling and disclosure requirements, the federal Act does not preempt state law. [See 15 USC §2311.]

1. WHAT THIS WARRANTY COVERS:

LG offers you a limited warranty that the enclosed subscriber unit and its enclosed accessories will be free from defects in material and workmanship, according to the following terms and conditions:

- (1) The limited warranty for the product extends for TWELVE (12) MONTHS beginning on the date of purchase of the product with valid proof of purchase, or absent valid proof of purchase, FIFTEEN (15) MONTHS from date of manufacture as determined by the unit's manufacture date code.
- (2) The limited warranty extends only to the original purchaser of the product and is not assignable or transferable to any subsequent purchaser/end user.
- (3) This warranty is good only to the original purchaser of the product during the warranty period as long as it is in the U.S., including Alaska, Hawaii, U.S. Territories and Canada.
- (4) The external housing and cosmetic parts shall be free of defects at the time of shipment and, therefore, shall not be covered under these limited warranty terms.

(5) Upon request from LG, the consumer must provide information to reasonably prove the date of purchase.

(6) The customer shall bear the cost of shipping the product to the Customer Service Department of LG. LG shall bear the cost of shipping the product back to the consumer after the completion of service under this limited warranty.

2. WHAT THIS WARRANTY DOES NOT COVER:

(1) Defects or damages resulting from use of the product in other than its normal and customary manner.

(2) Defects or damages from abnormal use, abnormal conditions, improper storage, exposure to moisture or dampness, unauthorized modifications, unauthorized connections, unauthorized repair, misuse, neglect, abuse, accident, alteration, improper installation, or other acts which are not the fault of LG, including damage caused by shipping, blown fuses, spills of food or liquid.

(3) Breakage or damage to antennas unless caused directly by defects in material or workmanship.

(4) That the Customer Service Department at LG was not notified by consumer of the alleged defect or malfunction of the product during the applicable limited warranty period.

(5) Products which have had the serial number removed or made illegible.

(6) This limited warranty is in lieu of all other warranties, express or implied either in fact or by operations of law, statutory or otherwise, including, but not limited to any implied warranty of marketability or fitness for a particular use.

(7) Damage resulting from use of non LG approved accessories.

(8) All plastic surfaces and all other externally exposed parts that are scratched or damaged due to normal customer use.

(9) Products operated outside published maximum ratings.

(10) Products used or obtained in a rental program.

(11) Consumables (such as fuses).

3. WHAT LG WILL DO:

LG will, at its sole option, either repair, replace or refund the purchase price of any unit that is covered under this limited warranty. LG may choose at its option to use functionally equivalent re-conditioned, refurbished or new units or parts or any units. In addition, LG will not re-install or back-up any data, applications or software that you have added to your phone. It is therefore recommended that you back-up any such data or information prior to sending the unit to LG to avoid the permanent loss of such information.

4. STATE LAW RIGHTS:

No other express warranty is applicable to this product. THE DURATION OF ANY IMPLIED WARRANTIES, INCLUDING THE IMPLIED WARRANTY OF MARKETABILITY OR MERCHANTABILITY OR FITNESS FOR A PARTICULAR PURPOSE, IS LIMITED TO THE DURATION OF THE EXPRESS WARRANTY HEREIN. LG SHALL NOT BE LIABLE FOR THE LOSS OF THE USE OF THE PRODUCT, INCONVENIENCE, LOSS OR ANY OTHER DAMAGES, DIRECT OR CONSEQUENTIAL, ARISING OUT OF THE USE OF, OR INABILITY TO USE, THIS PRODUCT OR FOR ANY BREACH OF ANY EXPRESS OR IMPLIED WARRANTY, INCLUDING THE IMPLIED WARRANTY OF MARKETABILITY OR MERCHANTABILITY OR FITNESS FOR A PARTICULAR PURPOSE APPLICABLE TO THIS PRODUCT.

Some states do not allow the exclusive limitation of incidental or consequential damages or limitations on how long an implied warranty lasts; so these limitations or exclusions may not apply to you. This warranty gives you specific legal rights and you may also have other rights which vary from state to state.

5. HOW TO GET WARRANTY SERVICE:

To obtain warranty service, please call or fax to the following telephone numbers from anywhere in the continental United States:

Tel. 1-800-793-8896 or Fax. 1-800-448-4026

Or visit <http://www.lg.com/us/support>. Correspondence may also be mailed to:

LG Electronics Service- Mobile Handsets, P.O. Box 240007, Huntsville, AL 35824

DO NOT RETURN YOUR PRODUCT TO THE ABOVE ADDRESS. Please call or write for the location of the LG authorized service center nearest you and for the procedures for obtaining warranty claims.

PROCEDURE FOR RESOLVING DISPUTES:

ALL DISPUTES BETWEEN YOU AND LG ARISING OUT OF OR RELATING IN ANY WAY TO THIS LIMITED WARRANTY OR THE PRODUCT SHALL BE RESOLVED EXCLUSIVELY THROUGH BINDING ARBITRATION, AND NOT IN A COURT OF GENERAL JURISDICTION. BINDING ARBITRATION MEANS THAT YOU AND LG ARE EACH WAIVING THE RIGHT TO A JURY TRIAL AND TO BRING OR PARTICIPATE IN A CLASS ACTION.

Definitions. For the purposes of this section, references to “LG” mean LG Electronics MobileComm U.S.A., Inc., its parents, subsidiaries and affiliates, and each of their officers, directors, employees, agents, beneficiaries, predecessors in interest, successors, assigns and suppliers; references to “dispute” or “claim” shall include any dispute, claim or controversy of any kind whatsoever (whether based in contract, tort, statute, regulation, ordinance, fraud, misrepresentation or any other legal or equitable theory) arising out of or relating in any way to the sale, condition or performance of the product or this Limited Warranty.

Agreement to Binding Arbitration and Class Action Waiver. You and LG agree to resolve any claims between us only by binding arbitration on an individual basis, unless you opt out as provided below. Any dispute between you and LG shall not be combined or consolidated with a dispute involving any other person’s or entity’s product or claim. More specifically, without limitation of the foregoing, any dispute between you and LG shall not under any circumstances proceed as part of a class or representative action. Instead of arbitration, either party may bring an individual action in small claims court, but that small claims court action may not be brought on a class or representative basis.

Arbitration Rules and Procedures. To begin arbitration of a claim, either you or LG must make a written demand for arbitration. The arbitration will be administered by the American Arbitration Association (AAA) and will be conducted before a single arbitrator under the AAA’s Consumer Arbitration Rules that are in effect at the time the arbitration is initiated (referred to as the “AAA Rules”) and under the procedures set forth in this section. The AAA Rules are available online at www.adr.org/consumer. Send a copy of your written demand for arbitration, as well as a copy of this provision, to the AAA in the manner described in the AAA Rules. You must also send a copy of your written demand to LG at LG Electronics, USA, Inc. Attn: Legal Department- Arbitration 1000 Sylvan Avenue Englewood Cliffs, NJ 07632. If there is a conflict between the AAA Rules and the rules set forth in this section, the rules set forth in this section will govern. This arbitration provision is governed by the Federal Arbitration Act. Judgment may be entered on the arbitrator’s award in any court of competent jurisdiction. All issues are for the arbitrator to decide,

except that issues relating to the scope and enforceability of the arbitration provision and to the arbitrability of the dispute are for the court to decide. The arbitrator is bound by the terms of this provision.

Governing Law: The law of the state of your residence shall govern this Limited Warranty and any disputes between us except to the extent that such law is preempted by or inconsistent with applicable federal law.

Fees/Costs. You do not need to pay any fee to begin an arbitration. Upon receipt of your written demand for arbitration, LG will promptly pay all arbitration filing fees to the AAA unless you seek more than \$25,000 in damages, in which case the payment of these fees will be governed by the AAA Rules. Except as otherwise provided for herein, LG will pay all AAA filing, administration and arbitrator fees for any arbitration initiated in accordance with the AAA Rules and this arbitration provision. If you prevail in the arbitration, LG will pay your reasonable attorneys' fees and expenses to the extent required by applicable law. If the arbitrator finds either the substance of your claim or the relief sought in the demand is frivolous or brought for an improper purpose (as measured by the standards set forth in Federal Rule of Civil Procedure 11(b)), then the payment of all arbitration fees will be governed by the AAA Rules. In such a situation, you agree to reimburse LG for all monies previously disbursed by it that are otherwise your obligation to pay under the AAA Rules.

Except as otherwise provided for, LG waives any rights it may have to seek attorneys' fees and expenses from you if LG prevails in the arbitration.

Hearings and Location. If your claim is for \$25,000 or less, you may choose to have the arbitration conducted solely on the basis of (1) documents submitted to the arbitrator, (2) through a telephonic hearing, or (3) by an in-person hearing as established by the AAA Rules. If your claim exceeds \$25,000, the right to a hearing will be determined by the AAA Rules. Any in-person arbitration hearings will be held at a location within the federal judicial district in which you reside unless we both agree to another location or we agree to a telephonic arbitration.

Opt Out. You may opt out of this dispute resolution procedure. If you opt out, neither you nor LG can require the other to participate in an arbitration proceeding. To opt out, you must send notice to LG no later than 30 calendar days from the date of the first consumer purchaser's purchase of the product by either: (i) sending an e-mail to optout@lge.com, with the subject line: "Arbitration Opt Out" or (ii) calling 1-800-980-2973. You must include in the opt out e-mail or provide by telephone: (a) your name and address; (b) the date on which the product was purchased; (c) the product model name or model number, and (d) the IMEI or MEID or Serial Number, as applicable (the IMEI or MEID or Serial Number can be found (i)

on the product box; (ii) on a label on the back of the product beneath the battery, if the battery is removable; or (iii) from the settings menu via the following path:

Settings > About tablet > Status).

You may only opt out of the dispute resolution procedure in the manner described above (that is, by e-mail or telephone); no other form of notice will be effective to opt out of this dispute resolution procedure. Opting out of this dispute resolution procedure will not affect the coverage of the Limited Warranty in any way, and you will continue to enjoy the full benefits of the Limited Warranty. If you keep this product and do not opt out, then you accept all terms and conditions of the arbitration provision described above.

