



Aquaris C

Complete User Manual

Aquaris C

The BQ team would like to thank you for purchasing your new Aquaris C. We hope you enjoy using it.

Enjoy the fastest mobile network speeds with this unlocked smartphone thanks to **4G** coverage. Its dual-SIM functionality (nano-SIM) means you can use two SIM cards at the same time, even if they are from different operators. You can browse the internet rapidly, check your email, enjoy games and apps (which can be acquired directly from the device), read e-books, transfer files via Bluetooth, record audio, watch films, take photos and record videos, listen to music, chat with your friends and family and enjoy your favourite social networks. It also comes with a fingerprint scanner, enabling you to add a digital fingerprint to unlock your smartphone, authorise purchases or sign in to an application.

About this manual

- To make sure that you use your smartphone correctly, please read this manual carefully before you start using it.
- Some of the images and screenshots shown in this manual may differ slightly from those of the final product. Likewise, due to firmware updates, it is possible that some of the information in this manual does not correspond exactly to the operation of your device.
- BQ shall not be held liable for any issues relating to performance or incompatibility resulting from modification of the registry settings by the user. Nor shall it be held liable for any incompatibility issues with third-party applications available through the app stores.

Icon guide



Danger: situations that could pose a risk to personal safety or health.



Warning: situations that could pose a risk to the correct functioning of the device but not to personal safety or health



Tip: additional information to help you make the most of your device.

Trademarks

The BQ logo is a registered trademark of Mundo Reader, S.L.

The Google™ logo, Android™ and other brands, are registered trademarks of Google Inc.

Wi-Fi® is a registered trademark of the Wi-Fi Alliance. Bluetooth® is a registered trademark of Bluetooth SIG, Inc. MicroSD™ and the corresponding logo are registered trademarks of SD-3D, LLC.

Qualcomm is a registered trademark of Qualcomm Incorporated, registered in the USA and other countries.

All other trademarks are the property of their respective owners. All rights reserved.

Index

- 07** **Before You Start**
- 07 Box Contents
- 08 Product Overview

- 09** **Getting Started**
- 09 Inserting the SIM cards
- 10 Switching the Device On and Off
- 11 Inserting and Removing the microSD Card
- 12 Charging the Device and Transferring Files
- 14 Setup Wizard
- 15 Learning to Use the Multi-Touch Screen

- 17** **Desktop Features**
- 17 Adjusting Screen Rotation
- 17 Buttons and Icons
- 19 Screen Lock
- 20 Home Screen
- 23 Status Bar
- 24 Notification Bar
- 27 Lock Screen
- 28 Keyboard

- 29** **Telephone**
- 29 Managing Contacts
- 32 Calls
- 36 SMS and MMS

38	Settings
39	NETWORK AND INTERNET
39	Wi-Fi
39	Mobile Network
39	Data Usage
40	VPN
40	Aeroplane mode
40	Bluetooth
41	Cast screen
41	NFC
41	Android Beam
42	APPS AND NOTIFICATIONS
42	Postpone Individual Notifications
43	Notification Channels and Categories
43	Notification Dots
43	Quick Settings
44	BATTERY
45	DISPLAY
46	SOUND
48	STORAGE
48	SECURITY AND LOCATION
49	Device Security
50	Privacy
51	USERS AND ACCOUNTS
51	ACCESSIBILITY
51	Accessibility scan
52	GOOGLE
52	SYSTEM
52	Languages and Input
52	Gestures
53	Date and Time
53	Backup
53	System Update
53	Scheduled Power On and Off
53	Reset Options
53	About Phone

54	Multimedia
54	Camera
55	General Settings
57	Camera Mode
58	Video Mode
59	Photos
60	Apps
60	Individual Permission for Apps from Unknown Sources
61	Play Store
61	Chrome
62	Calendar
62	Maps and GPS Navigation
62	BQ Plus
63	Email
64	Calculator
64	Clock
65	Useful Advice
65	OTA Updates
65	Autofill Service
65	Smart Text Selection
65	BQ Launcher
66	Progressive Installation Progress Bar
66	New Emojis
66	Compress Files
66	New Picture-in-Picture Option (PiP)
67	Appendices
67	Appendix A: Technical Specifications
67	Appendix B: Cleaning and Safety
69	Appendix C: Disposing of this Product Correctly
70	Appendix D: Information regarding maximum transmission power and frequency bands.
71	Appendix E: Information on Exposure to Radio Waves and SAR (Specific Absorption Rate)
72	Appendix F: Federal Communication Commission Interference Statement

Before You Start

Box Contents

Before using your BQ smartphone for the first time, please check the contents of the box. If any of the following items are missing, contact the vendor that sold you the device.

- ✓ Aquaris C
- ✓ Type-C to Type-A USB 2.0 cable
- ✓ SIM key
- ✓ Qualcomm® Quick Charge™ 3.0 charger
- ✓ Documentation:
Warranty and important information



BQ genuine accessories comply with the strictest quality and safety standards. As a manufacturer, BQ guarantees the compatibility of its devices only with its genuine accessories. It will not be liable for damages caused by the use of third party accessories with BQ devices, or by the use of third party devices with genuine BQ accessories.

Product Overview



Do not attempt to remove the rear cover of your Aquaris C, as this may damage the device.
Do not remove the battery by any means. Removing it may invalidate the warranty.

Getting Started

Inserting the SIM cards

Your Aquaris C is a dual SIM smartphone which accepts two nano-SIM cards in the same slot.

You can access the SIM tray from the exterior of the device. Do not attempt to remove the battery cover.

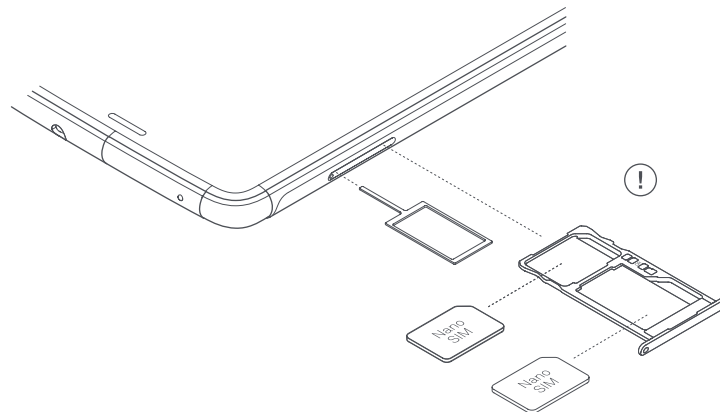

You will find the SIM key inside the box containing your device. Ensure the device is switched off, then extract the tray by inserting the key into the hole beside the SIM slot. Place your nano-SIM card into the tray. Make sure it is in the correct position by using the notch on the corner to guide you (see image). Insert the tray and nano-SIM into the slot.



 Your Aquaris C only accepts nano-SIM cards.

Switching the Device On and Off

To switch on your Aquaris C, press and hold down the power button for a few seconds located on the side of the smartphone.

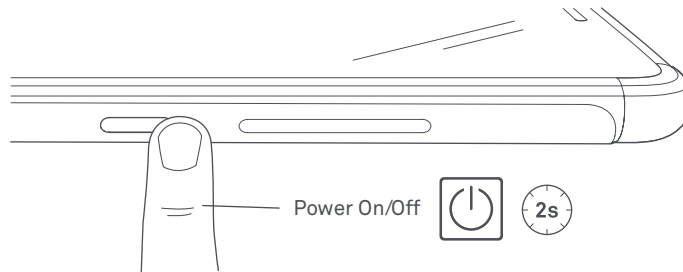

If there are two nano-SIM cards in your device, when switching it on you will need to enter the PIN for each one. Every time your Aquaris C detects a new SIM, a pop-up window appears informing you of the default settings for phone calls, video calls, SMS and the data connection.

To switch off your device, hold down the power button for two seconds. A menu will appear with various options. Select **Power off**.



If you press briefly on the power button, the screen will switch off but not the device.

Inserting and Removing the microSD Card

The internal memory of your Aquaris C can be expanded to 256 GB using a microSD card.

To insert a microSD card, follow these steps:

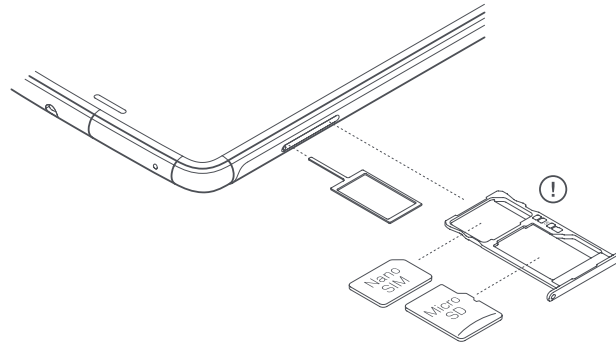

Insert the point of the SIM key into the ejector hole.

Extract the tray and place the microSD card on it. Make sure the metal pins are pointing toward the inside of the device (see image).

To remove the microSD card, follow the same steps but in reverse order, keeping in mind the following recommendations:

- For extra security we recommend the device be switched off before removing the microSD card.
- To remove it while the device is switched on, first unmount the card to avoid damaging it and losing data. To do this, go to **Settings > Storage > SD Card** and tap the ▲ icon (Unmount).
- Make sure you reinsert the tray to prevent dust or dirt from entering the device.



Note that the use of the microSD card will be limited to Portable storage. Applications cannot be installed on it and it will only serve to support the device's internal memory. Only information such as photos, videos or some external application data (provided the application allows this) can be stored.

Charging the Device and Transferring Files

Your smartphone contains a rechargeable (non-removable) 3000 mAh battery which is charged via the USB type-C port located at the bottom of the device. To charge the battery, a Type-C to Type-A USB 2.0 cable and a Qualcomm® Quick Charge™ 3.0 charger are supplied with the telephone. To charge, follow these simple steps:

A) Using the supplied mains adapter:

1. Plug the Type-A USB 2.0 end of the cable into the USB port of the mains adapter.
2. Plug the mains adapter into any standard power socket (220V/50Hz).
3. Plug the USB Type-C end of the cable into your smartphone's USB C port.

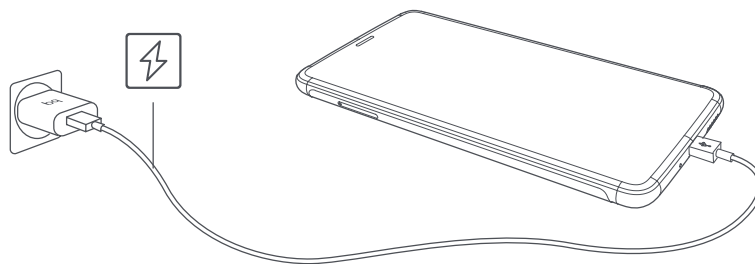

B) Using a laptop or desktop computer:

1. Connect the Type-A USB 2.0 end of the cable to a compatible USB port on your computer.
2. Plug the USB Type-C end of the cable into your smartphone's USB C port.



The battery in your Aquaris C is non-removable. Removal by anyone other than our Technical Support staff may damage the device and invalidate the Warranty.



Allowing the battery to charge fully (2h 20 min) is recommended when you charge it for the first time. This will help calibrate the battery meter. Note that some batteries perform better after completing a number of charge cycles. The time required to charge your device can vary markedly depending on whether it is charged via the mains adapter or a computer USB port.

Connecting your smartphone to a computer using the USB cable also allows you to **transfer** files between the two devices (from its internal memory or from the inserted microSD card). This will allow you to use, copy or store images, videos, music, text documents, etc. on one or both devices.

On connecting the device to a computer, a pop-up window appears with a notification containing access options to your data. The **media transfer protocol (MTP)** is the default option. It lets you access your documents from the computer. Tap **Allow** to accept this option.

To eliminate data connections and file transfers between the computer and the device, tap **Charge only**.

Tick the **Remember selection always** box to remember the chosen option. In this way, the next time you connect the device to the computer, this will be the option used.

More file transfer options can be accessed by pulling down the notification bar and tapping **Use USB to transfer files**.

The connection options are: **Charge this device**, **Transfers file (MTP)**, **Transfer photo (PTP)** and **Use device as MIDI**, which allows the connection of musical instruments or other devices with MIDI inputs, such as keyboards.

There are a number of ways to transfer files. The following steps explain how to do this via a USB connection:

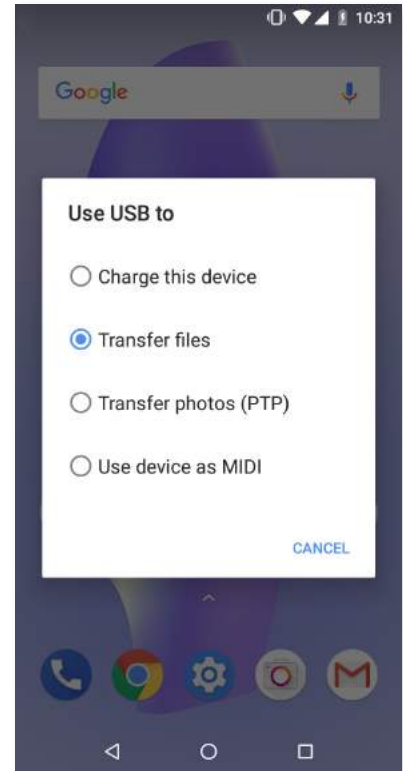

1. Connect your Aquaris C to a computer using the the micro-USB to Type-A USB 2.0 cable provided. Insert the micro-USB connector into the device's micro-USB port, and the generic USB connector into the computer's USB port.
2. Select and copy the desired files to your smartphone or computer. Note that you can store them on either the telephone's internal memory or the microSD card if you are using one.



To transfer files in PTP modes between your mobile (and/or microSD card) and a Mac OS computer, download and install the free **Android File Transfer** application to your computer: www.android.com/filetransfer/.



Do not disconnect the cable while files are being transferred.

Setup Wizard

The first time you switch on your Aquaris C, a setup wizard will help you to configure the basic settings for your device:

- Language
- SIM cards
- Wi-Fi networks
- Google account
- Protect your phone
- BQ Services
- BQ Plus

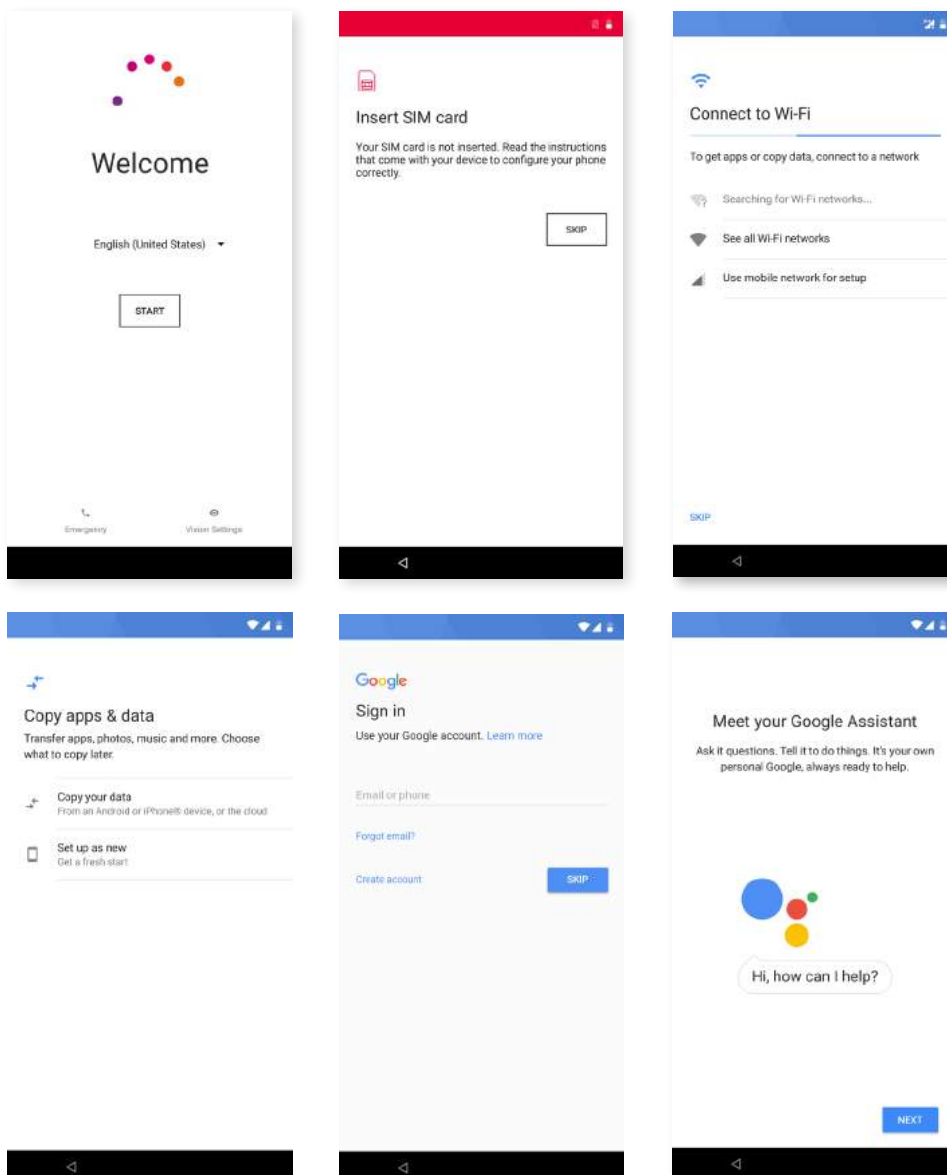

After adding your Google account you have the option to add another account in the Gmail application.

Learning to Use the Multi-Touch Screen

Your smartphone has a capacitive multi-touch screen with five simultaneous detection points. Different movements, which are linked to different functions, can be made using these points:



Touch. Touch the screen briefly to select an icon, open an app, activate a text-entry box, etc.



Long press. Touch the screen and hold for approximately 2 seconds to bring up an options menu.

Drag. To move an icon, long-press it, drag to the desired position and then release.

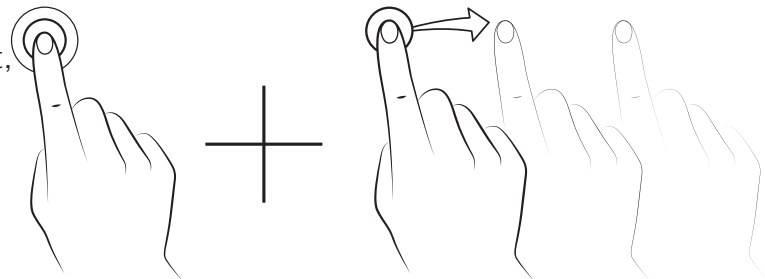



Swipe or slide. Swipe your finger left or right on the Home screen to access the extended screens. Slide it up or down to scroll through a website, list or menu.

Pinch. Place two fingers on the screen at the same time, separate them to zoom in and bring them together to zoom out.

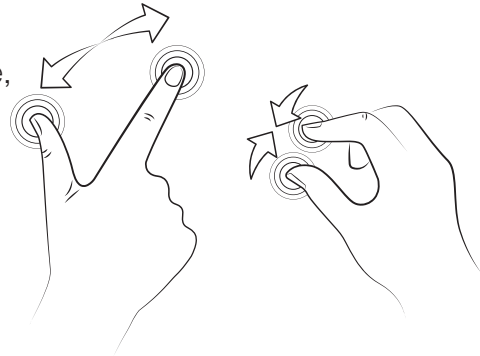

Double-tap. Tap the screen twice in quick succession to zoom in. Repeat the action to zoom out. This can also be used to activate the screen.



Desktop Features

Adjusting Screen Rotation

With some apps the screen will rotate automatically from portrait (vertical) to landscape (horizontal) and vice versa depending on how you are holding your device. To lock the screen rotation, go to **Settings > Display > Advanced > Auto-rotate screen** and disable it.

Automatic screen rotation can also be enabled or disabled using the Auto-Rotate toggle in the quick settings menu.

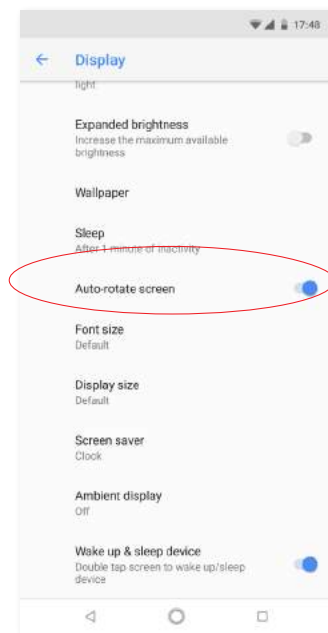

Buttons and Icons

The navbar is shown on screen by default to enable you to navigate through the screens of your device with ease.



You can return to a previous screen when using an app by pressing the **Back button** ◀.

You can go to the **Home screen** at any time by pressing the **Home button** ○. You can also long-press it to access the Google Assistant.

Access the recent applications list by pressing the **Menu button** □ located in the bottom right corner of the device. Double tapping it opens the last app you used. Additionally, pressing and holding this button while the recent apps list is open will enable Multiwindow mode.



The logo  (see photo) is not a working button.

This feature provides an improved multitasking experience by allowing two apps to be open on the screen.

To start **multiwindow mode**, one app has to be open and there must be at least one more running in the background. Long-pressing the Recent apps button in the bottom right corner of the device will shift the current app to the top part of the screen, leaving the bottom part free for whichever app you choose from the recent apps list.

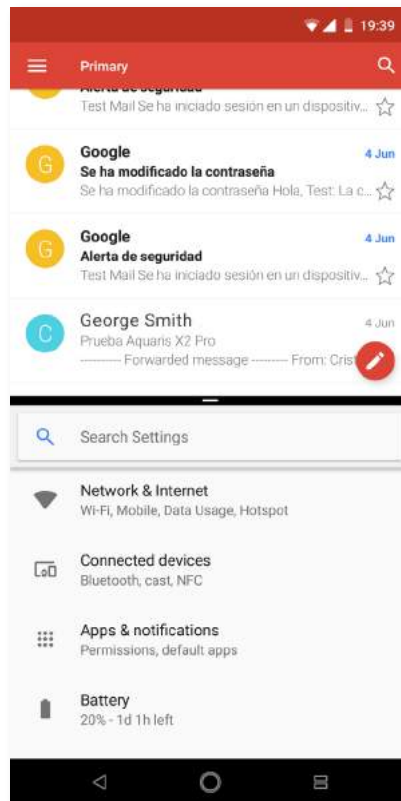

Resize the split-screen as desired by sliding the black divider up or down.

To exit multiwindow mode, slide the divider to the screen's upper or lower edge depending on which app you want to leave open. Long-pressing the Recent apps button will also exit this mode, leaving the app at the top of the screen open.

Screen Lock

By default, the screen of your smartphone will lock itself automatically after a prolonged period of inactivity. To set the length of this time period, go to **Settings > Display > Screen saver** and select the desired value. To switch the screen off manually, press the power button briefly.

To unlock the screen, press the power button briefly and the screen will come on, displaying the unlock option. The screen will turn on and display the configured lock option. To change the lock option, go to **Settings > Security and location > Device security > Screen lock** and choose from the following: **None, Swipe, Pattern, PIN or Password**.

You can create a message to be displayed on the lock screen by tapping the  icon to the right of the **Screen lock** option.

Your Aquaris C comes with a function that lets you lock and unlock the phone by double tapping the screen. Double-tapping any part of the screen will make it turn on and request the unlock pattern. Double-tap again to turn it off.

This feature is disabled by default. You can activate it via **Settings > Display > Advanced > Wake up & sleep device**.

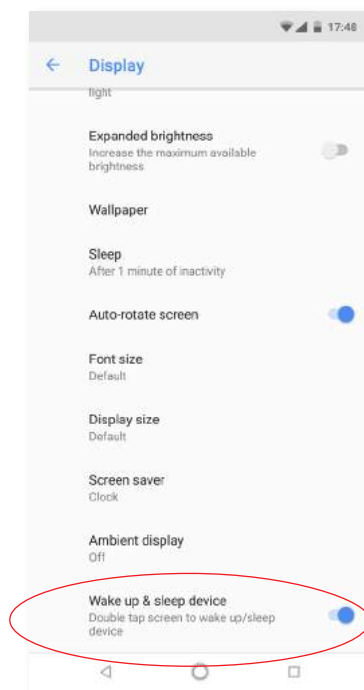

Home Screen

The **Home screen** or **Desktop** is the main access route to the tools and apps installed on your Aquaris. From here you can check the status of your device, visit websites, open apps, etc.



- 1** **Status and notification bar.** Check the time, Wi-Fi signal, network coverage for each SIM, audio profile, Bluetooth status and remaining battery power. Notifications such as missed calls, messages, etc. appear here. The quick settings and notifications are found in the same area. Swipe the bar downward to open it out. A first swipe will show a row of six quick settings tiles: A second swipe will reveal the rest of the tiles.
- 2** **Google Search.** Tap the search bar to enter the text you want to search for on the internet. Voice searches can also be performed.
- 3** **Widget.** Install widgets, such as Google cards (in the illustration), time, news, calendar, etc.
- 4** **Shortcuts.** These give you quick access to the apps you use most frequently.
- 5** **Access to the apps drawer.** Access all the applications installed on your device by swiping from the bottom of the screen or tapping the  icon.

Customising the Home screen



The **Home screen** can be extended to the right. To scroll through the **Home screen** and **Extended screens** swipe right or left. You can customise these screens with images, shortcuts, apps and widgets.

To change the wallpaper or add a widget, press and hold on one of the screens until a pop-up window appears containing these options:

- **Wallpapers:** select the image you want to use as a background for the Home Screen and Extended Screens then tap **Set wallpaper** to confirm. If the selected image is too large it will need to be cropped.

- **Widgets:** select the widgets you want to have on the **Home Screen**. They are distributed vertically and in alphabetical order to make them easier to find. Widgets belonging to the same app are positioned horizontally for more clarity. Long-pressing the sidebar displays the first letter of the applications, facilitating their identification.



- **Settings:** Two options for customising the Home screen are found here.
 - **Display Google application:** This function is enabled by default. Swipe the screen rightward to access **Google Now**, which lets you view cards and perform searches. This will have to be set beforehand by going to **Settings > Google > Search > Your feed** and ticking the box.
 - **Allow home screen rotation:** by default, the desktop is configured to be used vertically. Enable this option to use it horizontally. In this way you can rotate both the home screen and the apps drawer.

To create a shortcut to an app or contact go to the apps drawer, press on the app's icon and drag it to the desired position on the desktop.

App shortcuts can also be created from an app icon regardless of whether it is on the Home screen or in the apps drawer. Long-pressing an app icon reveals a menu containing quick actions or shortcuts offered by the said app.

For example, you can create a reminder or event by long-pressing the Google Calendar icon, or access Battery settings, Data usage or Wi-Fi by long-pressing the Settings icon.

Tapping elsewhere on the screen will make the shortcuts menu disappear.

An app shortcut can be added to the **Home screen** by long-pressing and then dragging it to the desired position.

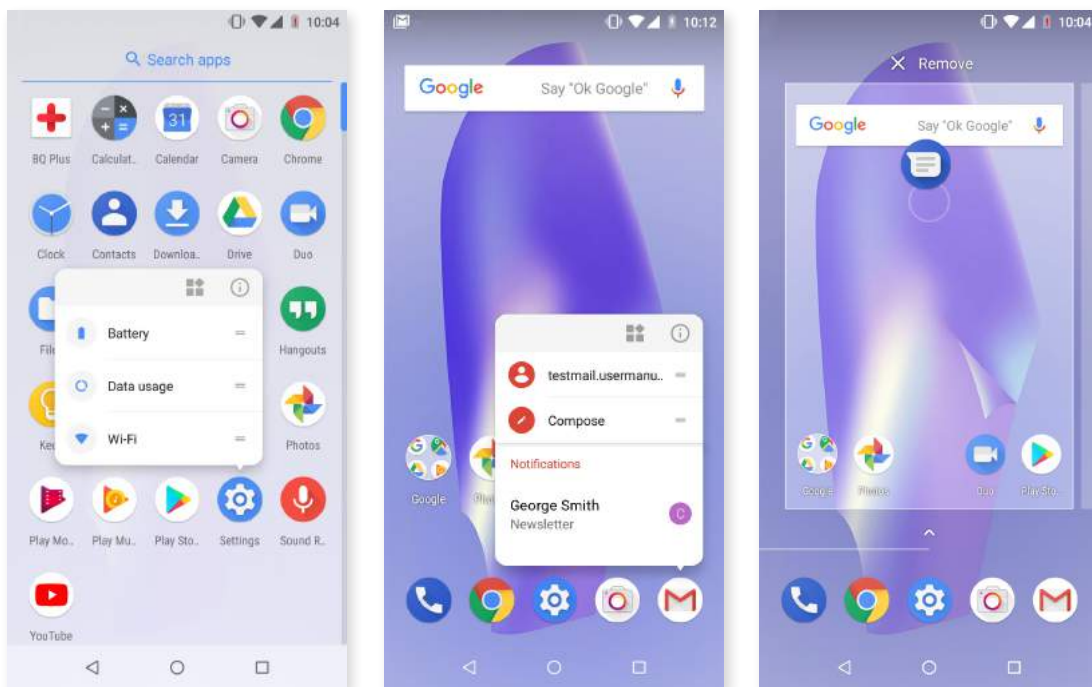

Not all apps have app shortcuts.

Grouping items into folders

Drag one item on top of another that is to be stored in the same folder. A folder will be created and the items placed inside it automatically. To place another item into this folder, simply drag it in. To name a folder (or rename an existing one), tap to open it, then tap the "Unnamed folder" option. The keypad will then appear, enabling you to type in the name of the folder. Items can be removed from the folder by opening it and dragging them out.

Moving, deleting or uninstalling items on the Home Screen

To move an item on the **Home screen**, long-press it to detach it from the background, drag it to the desired position and release. You can also move items from one extended screen to another by dragging them to the screen's edge.

To delete an item drag it to the cross labelled **Remove**. When the icon turns grey, release it to delete.

To uninstall an app drag it to the labelled **Uninstall** . When the icon turns red, release it to uninstall.











To obtain information on an app, drag it to the icon  labelled **App info**. When the icon turns blue, release it.



Note that only user-installed applications can be uninstalled.

Status Bar

The Status bar contains important information on the device and is always visible at the top of the screen:

-  Battery almost flat.
-  Battery charging.
-  Battery fully charged.
-  Wi-Fi enabled and connected to a network.
-  Sound off and vibrate on.
-  Do Not Disturb mode enabled.
-  Aeroplane mode.
-  Data services enabled (this could be 4G, H+, H, 3G, E or G, according to the type of data connection and transfer speed).
-  Bluetooth enabled.
-  Shows the battery level of the device connected by Bluetooth.

Notification bar

The notifications and quick settings have now been integrated into one screen. To view the notifications, pull the bar down with one finger. Dismiss them all at once by tapping **Clear all**, or swipe them to the side one by one.

The notifications are more interactive. They're expandable, show content and are bundled by app. Replying to a message received through a messaging app can be done directly from the notification.

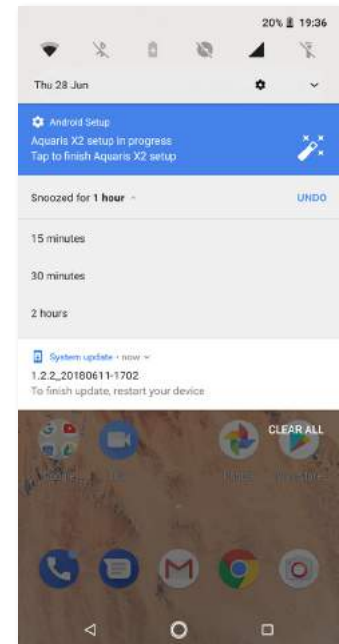

Swipe the notification gently right or left and the **Settings**  icon will appear, giving you access to the rest of the settings.

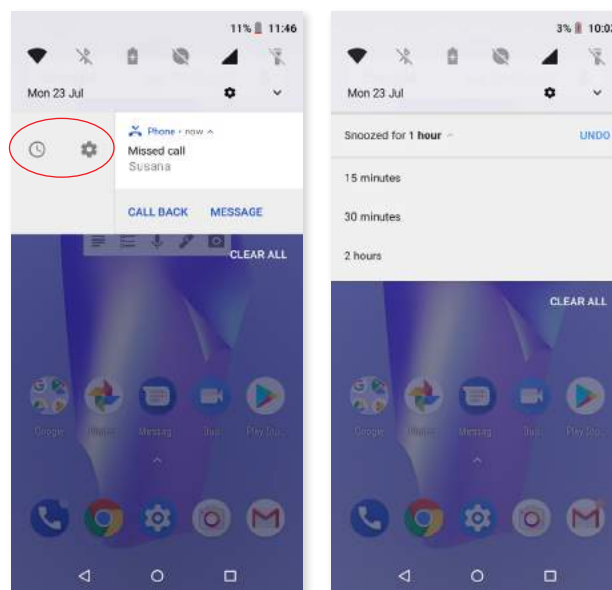

If you get a notification that you can't deal with at the time, you can now swipe the app to the right and, before discarding the notification, a clock will appear enabling you to postpone the notification so that you receive it again in an hour, or you can personalise the interval to 15 minutes, 30 minutes, or 2 hours later.



Note that replying from the notification is only possible if the app supports this feature.

Swiping the **Notification bar** down with one finger reveals a row of six quick settings tiles. Swiping it down with two fingers, or tapping the **∨** icon, shows the rest of the options, which provide quick and easy access to many settings.

Use the icon  in the top right corner to choose which options to display or hide. Some options, which are hidden by default, will be explained in more detail later. The order of these can be changed by long-pressing a toggle and then dragging it to a new position.

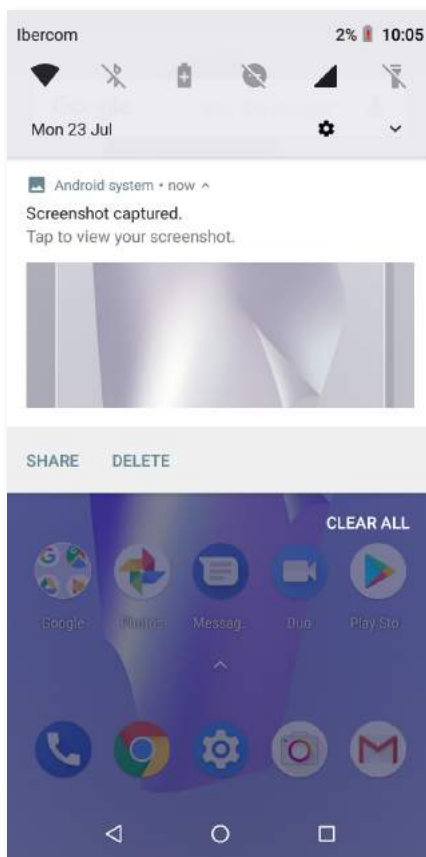



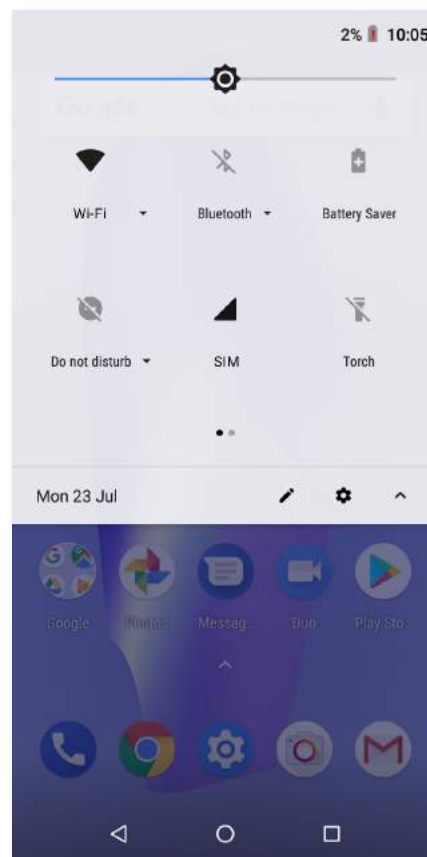





















Swipe with 1 finger







Swipe with 2 fingers

Tap the icon **∧** in the top right corner to return to the notification shade. To return to the **Home screen** simply tap outside of the quick settings area or swipe it upward.

The following options can be enabled/disabled via the pull-down menu:

-  **Wi-Fi:** enables/disables the Wi-Fi connection.
-  **Bluetooth:** enables/disables Bluetooth.
-  **Battery saver:** displays battery usage information. Details, such as a usage graph, the battery level percentage and the approximate time remaining are shown. Battery saver mode can also be enabled/disabled here.
-  **Do not disturb:** enables/disables Do Not Disturb mode.
-  **SIM 1:** check the data usage of SIM 1.
-  **Torch:** turns the torch on or off.
-  **Aeroplane mode:** enables/disables signal reception and transmission.
-  **Location:** enables/disables your smartphone's GPS.
-  **Auto-rotate:** enables/disables automatic screen rotation.
-  **Cast screen:** detects remote screens to which images and sound can be sent.
-  **Hotspot:** enables your BQ device to be used as a hotspot, sharing your internet access with other devices.
-  **Tethering:** provides access to the tethering and portable hotspot settings.
-  **Adaptive Brightness:** select from adaptive or manual brightness adjustment and set the desired level.
-  **Notification LED:** enables or disables the notification LED.
-  **Invert colours:** inverts the colour values.
-  **Screenshot:** takes a picture of the screen via the pull-down menu.
-  **Screen record:** records real-time video of what is being shown on the screen.
-  **Suspend screen:** set the amount of time before 1m the screen turns off automatically.
-  **SIM 2:** check the data usage of SIM 2.
-  **NFC:** enables/disables NFC.
-  **Sound record:** opens the audio recording app.
-  **Lock:** enables you to lock the phone.
-  **Shutdown:** enables power-off via the pull-down menu.
-  **Sync:** enables/disables automatic syncing of the device.
-  **Volume:** access the volume settings.

-  **Data saver:** enables/disables data savings by allowing control over which apps can access the mobile data network.
-  **Night light:** enables/disables night light mode.
-  **Nearby:** provides access to Nearby settings. This feature uses Bluetooth to find, and interact with, services and devices that are near you.

 Advanced settings for certain functions, such as Wi-Fi or Bluetooth, can be accessed by long-pressing their icons.

 When automatic brightness is deactivated, you can adjust the brightness level of the screen by sliding your finger to the left or right.

 Some third-party apps let you add shortcuts, for performing specific actions, to the quick settings area.

Lock Screen



Google Voice search can be accessed from the lock screen by swiping from the lower left corner. To change the access from the bottom of the screen and configure it to open the **Phone app**, go to **Settings > Apps and notifications Advanced > Default apps > Assistance and voice input > Assist app** and select **None**. Then restart the device.

Swiping from the lower right corner provides access to the Camera app.

By pressing on **Emergency**, you can access any personal information and contacts you have added for use in the event of an emergency. You can also edit it via **Settings > Users and accounts > Emergency information**.

 If a PIN or Pattern lock is enabled, it will have to be entered before being able to access any applications, except for the camera which can be accessed to take pictures, but for security purposes, does not allow photos which have previously been saved in the gallery to be viewed.

Keyboard

Tapping a text field reveals a virtual keyboard.

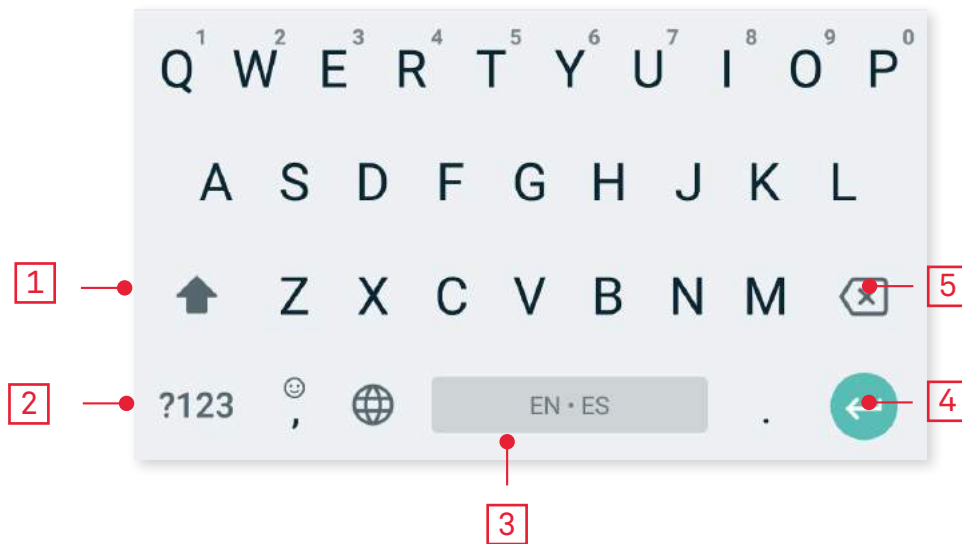

- 1 Enable/disable caps lock.
- 2 Change from letters to numbers and symbols, or vice versa.
- 3 Space.
- 4 Enter/return.
- 5 Delete.



The keyboard options may vary depending on the application being used.



More information about keyboard settings and text input languages is available in **Settings > System > Languages and input**.

Phone

The phone book included with our Aquaris C is the **Google Contacts app**, which varies slightly from the AOSP that we were using until now. The **Google Contacts app** allows contacts to be saved in the app itself to avoid losing any contacts when saving them on the SIM card or Phone. The SIM is an external element that could get broken, damaged or lost, and if you change to another company, a change of the physical card is usually necessary. If they are saved in the Phone memory, if it does not switch on as normal for any reason, the information contained inside could be lost. The Google account saves a permanent backup of the contacts, which can be viewed or edited using other devices or computers simply by logging in to the same account.

Managing contacts

The **Contacts** application provides access to all of your saved contacts on your SIM card, the internal memory of your device and any online accounts you have set up. You have different options available depending on where you have saved your contacts.

Using this application you can:

- Create new contacts.
- Update existing contacts.
- Create groups of contacts.
- Select the lists you wish to display.
- Make phone calls or send SMS.

Adding a contact

Adding a new contact to a list can be done manually via the **Contacts** app or from the **Call log**:

To add a contact manually:

1. Access the **Contacts** app.
2. Tapping the  icon will display a list of available accounts to which the contact can be saved.
3. Fill in the desired fields:
 - a. Name and surname
 - b. Telephone
 - c. EmailTap **More** fields to add more details about your contact. Extra fields such as Postal address, Company, Notes, Group name, etc. are available.
4. Tap **SAVE** to add the contact.

To add a contact via the **Call log**, tap the contact  icon to the left of the number you wish to save, then tap the **Create new contact** option (or add this number to an existing contact). Next, select the account to which to save the new contact and fill in the fields as described above.

Tapping the number will show a list with the following options: **Create new contact**, **Add a contact**, **Send message**, **Block/mark as spam** and **Call details**.



Editing an existing contact

1. Access the **Contacts** app.
2. Select the contact you want to edit.
3. Tap the  icon.
4. Tap on one of the existing fields to edit it, or on **More fields** to add new data.
5. Tap **SAVE** to save the changes.

Using a contact

The **Contacts** application can be used to communicate with previously added contacts, either by making a call, sending a text message or other.

Simply press the name of the person you want to contact to access their details. From here you can:

- Make a phone call
 - Tap the telephone icon  beside the number you want to call.
- Send an SMS
 - Tap  and enter a message.
- Send an email
 - Tap the desired email address.
- Other options (tap the  icon in the top right corner)
 - Delete: delete the contact.
 - Share: send information about the current contact to another contact.
 - Place on **Home screen**: create a shortcut to this contact on the desktop.

Create a Group of Contacts

Easily organise contacts into groups with the **Contacts** app. Save contacts to your Gmail account to be able to do this. For example, you can have different groups for friends, colleagues, family, etc.

To create a group:

1. Select the contact you want to add to a group.
2. Tap the  icon to edit the contact.
3. Tap **More fields** and slide your finger to the “Group name” field.
4. Select the group name or tap **Create new group**.
5. Tap **SAVE** to save the group. It will appear in the list of groups in the **Contacts** app.

Contacts to display

Select which contacts you want to be displayed in the list. Choose from those saved in the Gmail account or Facebook contacts, among others.

To select the lists:

1. Open the contacts list and press the icon .
2. Select the Custom view option
3. Select which contact groups you want to be displayed:

Importing and exporting contacts

This option allows you to copy a series of contacts from one source and paste it to another account, app or the internal phone memory. To do this:

1. Tap the icon  in the list of contacts, Settings.
2. From Manage contacts, tap Import /Export.
3. Choose from the following options: Import from SIM card, Export to SIM card, Import .vcf file, Export to .vcf file or Share all contacts.
4. According to the option chosen, select the location for pasting or the contacts you want to copy.



We recommend that you always save contacts to your Google account. Apart from providing you with a backup copy if your device is lost or stolen, these contacts can be remotely accessed from any other device.

Calls

Tap the  icon on the **Home screen** to access the call menu. Your favourite contacts appear here, defined as the people you are most frequently in touch with. Tap **Contacts** to open the list of contacts. From **Recents** you can access the chronologically ordered log for incoming and outgoing calls. This menu enables you to:



- View the contacts that you call the most.
- View the log for incoming and outgoing calls.
- Make calls.

Phone calls can be made in a number of ways:



VIA CONTACTS

1. Access **Contacts** using any of the aforementioned methods.
2. Select the contact you wish to call by tapping their name.
3. Tap the telephone number or the  icon to place the call.

VIA THE CALL LOG

1. Tap the icon  on the Home screen.
2. Tap Recents .
3. Tap the contact you want to call then tap the  icon on the right.

VIA THE KEYPAD

1. Press the phone icon  on the Home screen.
2. Press the icon  to display the keypad.
3. Enter the number you want to call.
4. Press the icon  at the bottom of the screen to call the number you have entered.



If a call is received while the device is locked you can choose to answer it, reject it or respond with a text message.

The telephone number of an incoming call will be displayed on the smartphone's screen. Available options are:

1. Swipe the call icon upward to accept the incoming call.
2. Swipe the call icon downward to reject the incoming call.
3. Tap the message icon (located in the bottom left corner) to respond to the call with a text message.







If a call is received while the device is unlocked a dialogue box with a notification will appear near the top of the screen. Tap on **Answer** to accept the call or on **Decline** to reject it.



Options Available During a Telephone Call

At the top of the screen, the caller's name (if stored in your lists of contacts), the phone number (mobile and/or landline), the country they are calling from and the SIM card in use for this call will appear.

Various options will be displayed at the bottom of the screen during the call:

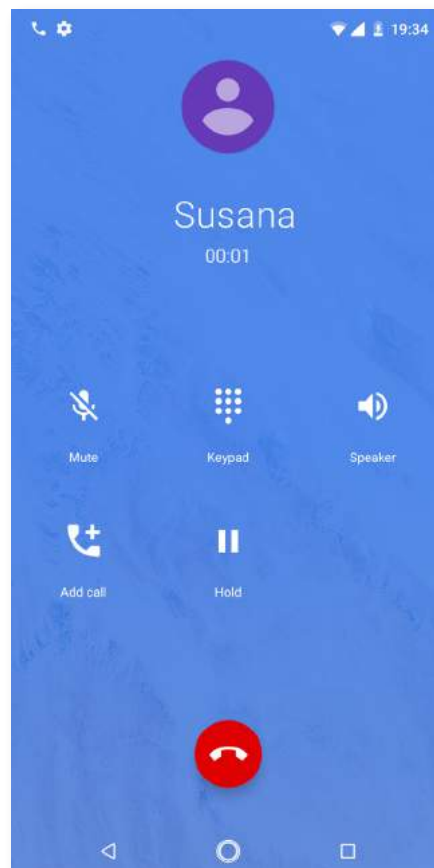

-  **Mute:** mutes the internal microphone.
-  **Keypad:** opens the numeric keypad.
-  **Speaker:** activates the external speaker providing hands free functionality.
-  **Add call:** add a third person to the conversation.
-  **Hold:** places the current call on hold.
-  **End the call.**



Once a connection has been established with the third person, you can switch between the two calls or merge them into a conference call (if your mobile network operator allows this).



Hiding the Caller ID

This option prevents your number from appearing on the device of the called person. To do this:

1. Press the  icon on the Home screen.
2. Press the  icon and select Settings.
3. Go to **Call Accounts** and select the SIM for which you wish to hide your number.
4. Additional settings.
5. Caller ID.
6. Select **Hide number**.

Call barring

To access the call barring menu:

1. Open the call application by tapping the  icon on the **Home screen**.
2. Tap the  icon and select **Settings**.
3. Select the **Calling accounts** option.
4. Select the Calling accounts option.
5. Select the desired barring option. (Barring will be applied to all calls, individual numbers cannot be barred):
 - a. Outgoing call barring.
 - b. Incoming call barring.
 - c. Cancel all call barring.
 - d. Change password.

New features have been added. These can be accessed by tapping the  icon and selecting **Settings**.

- **Caller ID and spam:** Google's database of phone numbers provides this information. When placing or receiving a call, you will be presented with details (a name, for example) on this number if it is not in your contacts. A warning will be displayed if the incoming call is suspected spam.
- **Nearby places:** uses your location to find nearby places that match your search criteria. Results can be improved by including entries from your search history. Enable this by marking the Personalised search results option.



To use the Nearby places feature the Dialer app must have permission to access your location. You can do this by going to **Settings > Apps and notifications > App permissions** and selecting the app.



Making a test call is recommended to check that you have hidden your number correctly. Some network operators do not allow hidden numbers. Consequently, your number will still be seen when making outgoing calls, despite having hidden the caller ID.

SMS and MMS

Google's new texting app is called **Android Messages**. This app enhances the messaging experience given that it is compatible with the new RCS standard (Rich Communication Services). This standard lets you send rich messages (for example, group text-messages or messages with emojis, images, videos, locations or audio notes) through data or Wi-Fi networks. The app can be opened via the apps drawer or its shortcut on the **Home screen**.

Create a new message by tapping the **+** icon in the bottom right corner. Select the recipient(s) by entering their name, telephone number or email address in the text-entry box near the top of the screen, or select them directly from your contacts list.

This application also allows the sending of MMS (multimedia messages). Tapping the **+** icon (to the left of the text entry field) will display the types of multimedia files that can be attached:

- Emoticons.
- Capture image or video.
- Image or video from the gallery.
- Record audio.
- Share location.

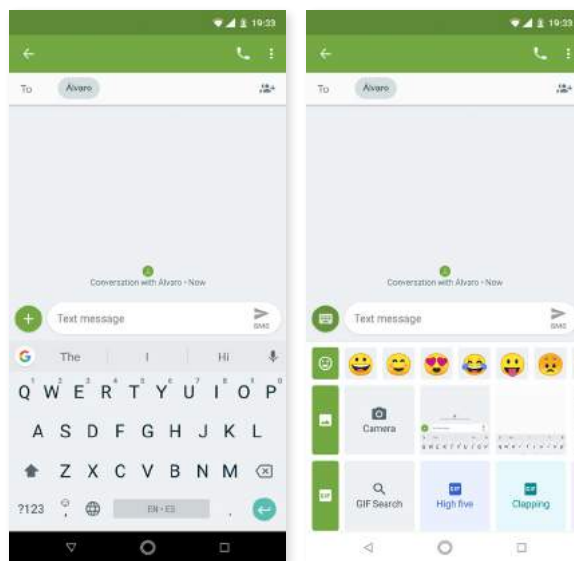



SMS messages are limited to 160 characters. Longer messages can be written and they will be sent as a single message, however, for billing purposes your network operator will treat them as several messages (one message per 160 characters). In contrast, there is no limit to the amount of text you can send with an MMS message. Note that if both devices (the sender and receiver) support the RCS standard, the communication turns into an instant messaging service where character limits do not apply.

Once the recipient and the text have been entered, and multimedia files have been attached (if sending an MMS), tap the send **SMS** icon .

Other options include replying to an existing message or the possibility of choosing the SIM from which you want to send. The icon to the right of the text entry field indicates the SIM in use, tapping it will toggle between SIM 1 and SIM 2.

Contacts can also be called with this app. Do so by tapping the  icon located in the top right corner.

Additionally, incoming calls or messages from a given number can be blocked via  > **Blocked contacts** > **Add a number**. Alternatively, long-press a message and select the **Block icon** .

Message Settings



Settings for the sending and receiving of SMS and MMS are found in the Messaging app. Press the  icon and go to Settings to configure the following general and advanced aspects:

- General
 - Default SMS app (by selecting the app to be used by default).
 - Notifications (select how to be notified)
 - Hear sound for sent messages
 - Current country
 - Automatic link previews
- Advanced
 - Group messaging
 - Automatically retrieve MMS
 - Automatically retrieve MMS while roaming
 - Use simple characters
 - Request SMS delivery reports
 - Wireless alerts
 - SIM card messages
 - Telephone number

 Both devices (the one sending the SMS and the one receiving) must be compatible with the RCS standard. Check that this is supported by your mobile network operator.

 Given that the SMS is sent through the data network, this will be billed as data usage. Conversely, calls are made via the usual line and their cost will depend on your operator's rates.

Settings

You can fully configure your device using the options listed in the **Settings** menu . Suggestions appear at the top of the menu for configuring your device, such as the wallpaper or your email account. You can delete the history by going to the  icon > **Delete history**. It also provides information on the default settings enabled, such as the Data saver or Do not disturb mode, and gives you the option to disable them.

Another novelty is that each item on the main page of the settings menu now shows its current status (for example, the Wi-Fi option shows the network in use and Data usage shows the amount of data used). This saves you time given as you don't need to go into the menu item in search of important information.

In each sub menu there is an **Advanced options** section containing a drop-down menu of the lesser-used options.

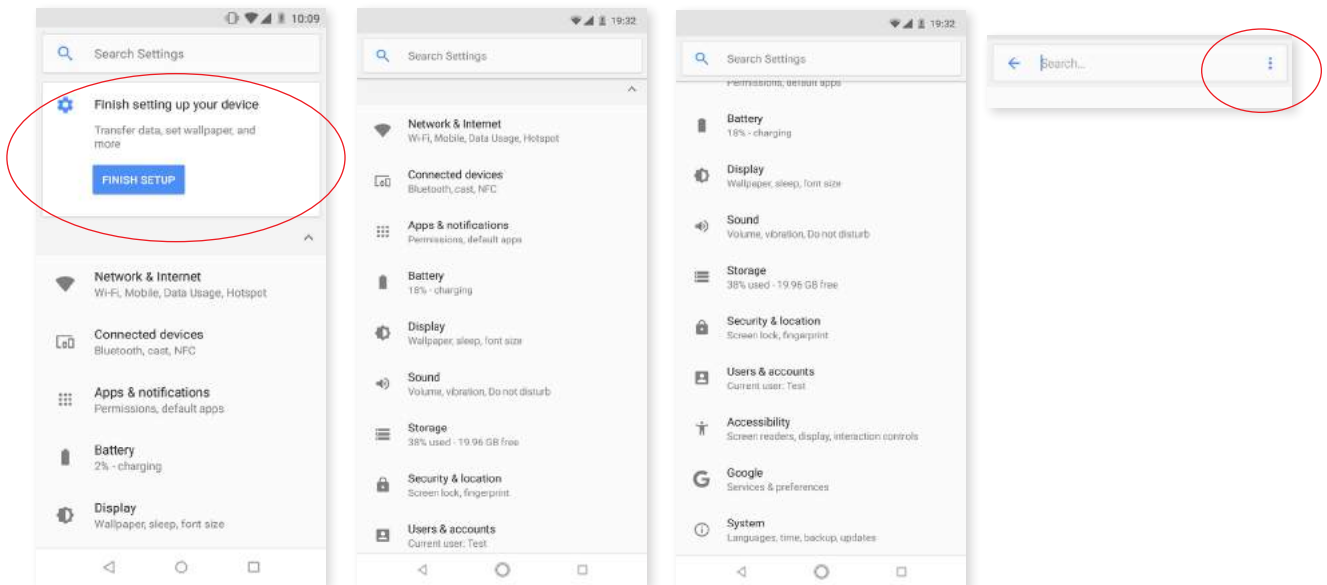

Network and internet

From this menu, you can access the following settings: *Wi-Fi, Mobile network, Data usage, Wi-Fi hotspot/ Tethering, VPN* and *Aeroplane mode*.

WI-FI

If Wi-Fi is disabled, move the selector to the right. Your BQ device will automatically search for available Wi-Fi networks. These are displayed in a list that refreshes automatically.

Tap the name of the network you want to connect to, enter the password if necessary and tap **Connect**. If it connects successfully, **Connected** will appear below the name of the network.

There is a time limit for entering the Wi-Fi password, after which the Wi-Fi will be disabled. We recommend marking the **Show password** checkbox before entering the password so that it can be written quickly and correctly.

When Wi-Fi is enabled, the device will automatically connect to the chosen network. Your BQ smartphone will notify you when it detects a network that you have never configured.

To access the options for Wi-Fi support, Install certificates, Wi-Fi Direct, WPS push button and WPS PIN entry for the Wi-Fi network, tap **Settings > Wi-Fi > Wi-Fi** preferences and select the Advanced settings WPS-PIN. You can continue entering your access password manually, however, the router may allow you to connect to your Wi-Fi network more conveniently and just as securely. Do this by synchronising your smartphone wirelessly with the router via Menu  **> WPS PIN** and pressing the WPS PIN physical button on the router.

MOBILE NETWORK

Access the settings for both SIM cards where you can enable data roaming, select the preferred network type, set up the APN and select a network operator.



Note that your device is Dual SIM Dual Standby, meaning that you cannot enable data on both SIM cards at the same time. However, it is possible to switch between the two while the device is turned on.

DATA USAGE

In this section, you can view an application's data-transfer statistics for Wi-Fi or mobile data. Additionally, in the section that corresponds to your SIM card you can enable or disable mobile data, see the amount of data you have used and see the data usage of resources and applications.

VPN

This option enables you to configure a virtual private network.

AEROPLANE MODE

Selecting this option will disable all wireless connections.

Connected devices

This option contains the settings for *Bluetooth*, *Send screen*, *NFC*, *Android Beam*, *Printing* and *USB*.

BLUETOOTH

Enable Bluetooth by going to **Settings > Connected devices > Bluetooth** and moving the selector to the right.

To rename your smartphone, show received files or access the advanced settings and pair your your smartphone, you must have the Bluetooth option enabled. The device will be visible as long as the user remains in the Bluetooth settings area.

To connect to another device, provided both are visible, simply tap the name of the device you want to connect to. A pop-up window will appear on your screen with a **Bluetooth pairing request**. Tap Pair on your BQ and confirm on the other device to sync them.

An option is included enabling you to view the battery level and the remaining percentage of the devices connected via Bluetooth. Simply pull down the quick settings panel for an overview of how much battery your device has left for example, when the speaker or headphones are connected via Bluetooth.

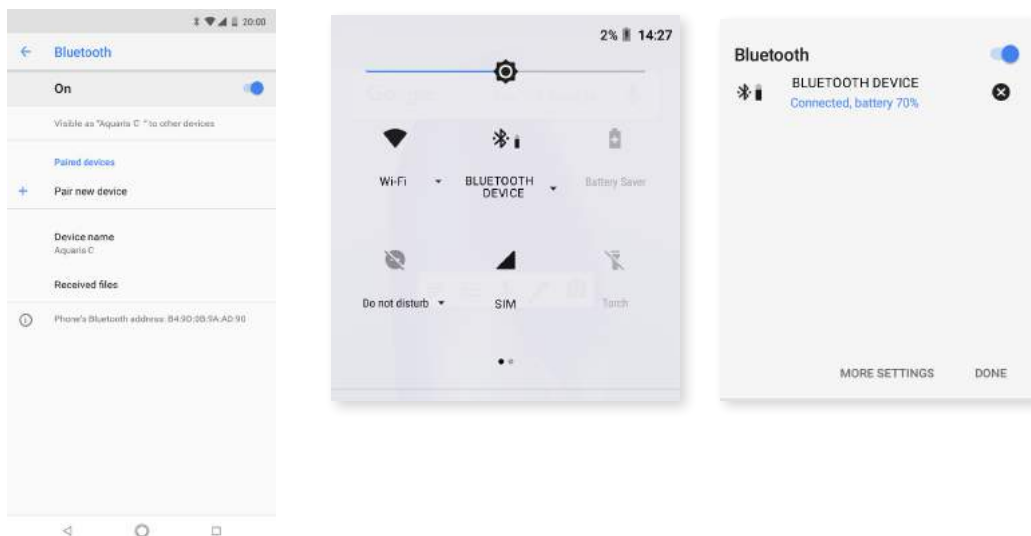

To be able to view the battery level remaining, the connected device must support this option.

CAST SCREEN

Your smartphone can send an audio/video signal to a remote screen (another smartphone, a tablet, television, etc.) via Wi-Fi, effectively mirroring the first screen on both devices. **Enable Cast screen** by tapping the  icon. The telephone will start searching for nearby wireless screens. Remember that for this to work the remote screen must be compatible with the Miracast or DLNA protocols. Follow these steps to configure your Aquaris and duplicate your device's screen:

1. Switch on your compatible TV and enable cast screen mode (the process will vary depending on the manufacturer)
2. On your smartphone, go to **Settings > Connected devices**.
3. Scroll down the list and select **Cast screen**.
4. From the list, select the screen to which you want to send audio/video.
5. After a few seconds you will see your smartphone's screen mirrored on the other device in real time.

NFC

Your Aquaris C is equipped with NFC (Near Field Communication) technology, a short range communication system.

In addition to file transfers, it allows payments to be made via contactless payment terminals and compatible bank applications. This feature is only available once it has been enabled in **Settings > Connected devices > NFC** to allow the exchange of data when the phone touches another device.

For proper operation:

1. Check that NFC is enabled on the device.
2. Ensure the payment app you are going to use is correctly set up by going to **Settings > Apps and notifications > Advanced > Default apps > Tap and pay > Payment default**.
3. Place the rear of the device close to the payment terminal (no further away than 4cm) and keep it still until a tone is heard. This indicates that the devices have been paired.



NFC

ANDROID BEAM

Allows app content to be shared when NFC is enabled.

Apps and notifications

The settings relating to notifications and apps permissions are located here.

Enhanced hierarchical organisation of your notifications. The notifications are not shown in order of arrival, instead, each type of notification now has its own space.

Notifications are grouped into four categories, being ordered from greater or lesser importance and differentiated by colour and height. The categories are “Ongoing notifications” (call, timer, music, navigation prompts, etc...), “Person to person” (messages or missed calls), “General notifications” (reminders, events, updates, etc...) and “By the way” (with less relevant notifications such as time, traffic, promotions, suggestions, etc ...).

Replying to a message received through a messaging app can be done right from the notification.

We recommend going to **Settings > Apps and notifications > Notifications**. From this menu, you will be able to personalise all the app notifications individually. This feature depends on the developer of each app, which means it could have more or fewer personalisation options.

POSTPONE INDIVIDUAL NOTIFICATIONS

If you get a notification that you can't deal with at the time, you can now swipe the app to the right and, before discarding the notification, a clock will appear enabling you to postpone the notification so that you receive it again in an hour, or you can personalise the interval to 15 minutes, 30 minutes, or 2 hours later.

This feature is available for any individual notification that appears:

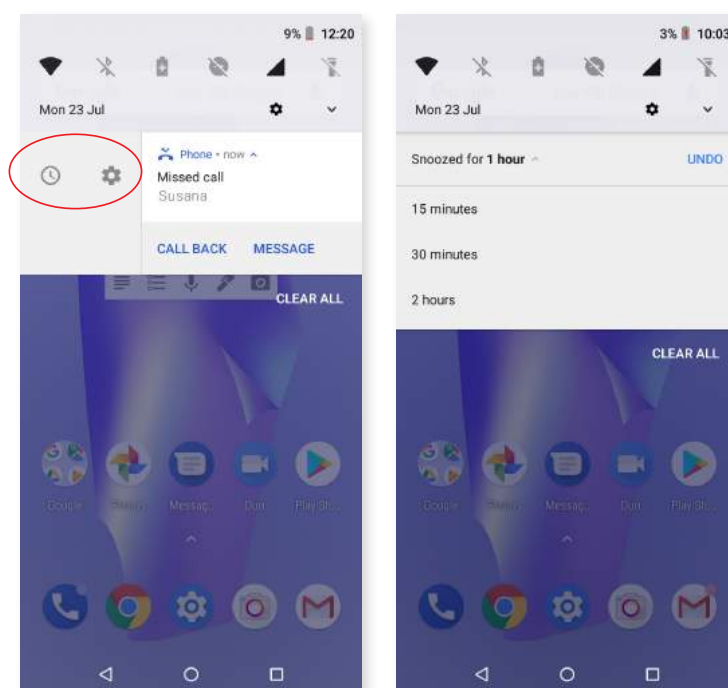

CHANNELS AND NOTIFICATION CATEGORIES

The new notification channels enable us to personalise the type of notifications that are shown by each app.

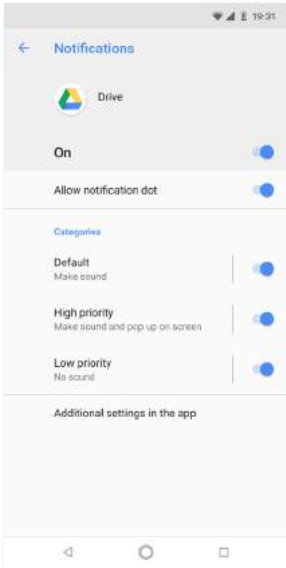

Previously, Android only allowed us to block all notifications generated by an app, but now we can select which ones we want to see and those we don't for each app using the system settings, without having to go to the settings of the app itself. This means that the notifications can be separated into categories depending on their content and the user's interests.

Enable and disable notifications for each app and select how you prefer to be notified (for example, by vibrating and showing the lock screen). What's more, within each app, you can assign different levels of importance (urgent, high, medium and low) to different notification categories. This can be done via **Settings > Apps and notifications > Notifications > App notifications**, then tap the app you want to personalise.

NOTIFICATION DOTS



A native feature is included with Android Oreo where a dot will appear on the app icons when there is a new notification. This is enabled by default with the Oreo update, so if you don't like it, you can disable it via **Settings > Apps and notifications > Notifications > Allow notification badge**.

On long-pressing on the icon, the available shortcuts and a summary of the pending notifications will appear. The widgets and app information have been incorporated into these shortcuts.

For example, you can create a reminder or event by long-pressing on Google Calendar or you can access the last email you received.

Tapping elsewhere on the screen will make the shortcuts menu disappear.

An app shortcut can be added to the **Home screen** by long-pressing and then dragging it to the desired position

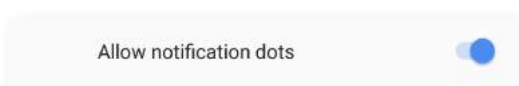

BACKGROUND COLOURS

Ongoing notifications appear with a coloured background, which adapts to multimedia content (for example, to the album cover).

QUICK SETTINGS

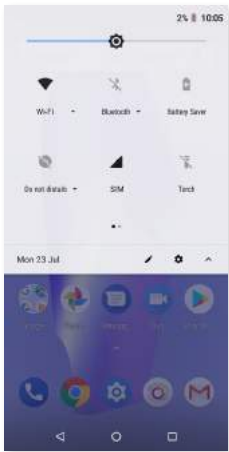

The notifications and quick settings continue to be integrated into one screen. To view the notifications, pull the bar down with one finger. Dismiss them all at once by tapping **Clear all**, or swipe them to the side one by one.

The quick settings are still accessed via the notifications bar, whereas the Power off/Lock/Sync settings have been removed and are now accessed via the specific menus and buttons.

Access to the advanced menus has been added in Android Oreo via the quick settings. All you need to do is long-press the selected quick settings and you will be taken to the rest of the options.

Battery

The battery control options can be accessed via this menu.

The main options include a graph showing the battery percentage remaining in real time, and other information, such as the date and time that it was last fully charged.

By pressing the battery icon we will access a more detailed consumption graph and by pressing the  icon we can access the **Battery Optimisation** or choose between **Show full use of the device** or **Show use of apps** to control the consumption of the battery more specifically.

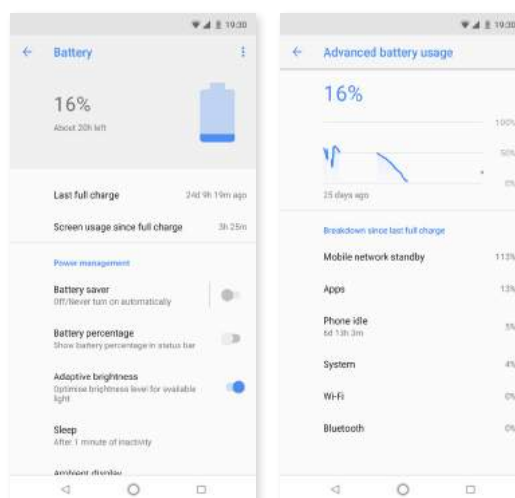

Background activity is minimised to reduce the battery consumption. For example, if an app requires your location, it will receive the last one recorded instead of activating the GPS. It also prioritises foreground processes so that apps are launched much faster.

Display

BRIGHTNESS LEVEL

Adjusts the brightness of the screen.

NIGHT LIGHT

When this feature is enabled the screen takes on an orangey tone that lowers the emission of blue light providing relief for the eyes. It has two settings: There are two options for configuring this mode:

1. Tap Schedule to choose how you want it to activate it.
2. When enabled, Night light will function in accord with how it has been set up.

This mode can be enabled/disabled via the quick settings (if you added it previously), and advanced settings can be accessed by long pressing its icon.

This option does not contain any new sections, only a few additional settings under **Night light**.

Night light was one of the most distinctive features of Nougat. The additional feature of allowing the colour intensity to be adjusted has been added.

NOTIFICATION LED

Set its colour and blink rate. These two parameters can be set using the coloured circle found in each option. Preset notifications, missed calls and low battery can be customised. This can also be done for individual apps by tapping **Customise notifications**.

ADAPTIVE BRIGHTNESS

Optimises the brightness level depending on ambient light.

WALLPAPER

Lets you choose an image to use as the screen background. Choose live wallpaper, system wallpaper or an image from your gallery.

SLEEP

Sets the time delay before the screen automatically switches off.

DEVICE ROTATION

Enables or disables automatic screen rotation when the smartphone is turned.

FONT SIZE

Four font sizes are available.

DISPLAY SIZE

Increase or decrease the size of items on the screen

SCREEN SAVER

Enables or disables this feature.

AMBIENT DISPLAY

Turns on the screen when a notification arrives. This feature makes your device wake up as soon as it is picked up and tilted at an angle of 35° or more.

TAP TO WAKE/SLEEP

Enabling this option allows the smartphone's display to be turned on or off with a double-tap.

Sound

Here you can access the settings relating to the device volume preferences, simply reorganised in a different way.

The volume levels for **ringtones**, **alarms**, **notifications** and **multimedia content** are all adjustable. Move the sliders left or right to set the volumes.

Furthermore, you can select the ringtone for each SIM, notification sounds and alarm sounds. You can also enable or disable sound and vibration for some system characteristics, such as: **Dial pad tones**, **Screen lock sounds**, **Touch sounds** and **Vibrate on touch**.

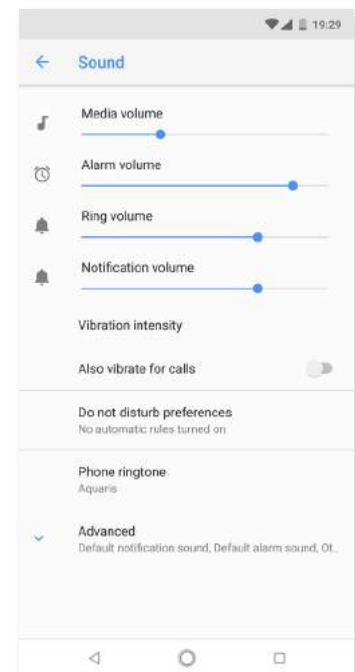

Enjoy your favourite ringtones and sounds

Add your own ringtones and sounds without having to import them from a computer or other apps: on selecting the ringtone, you can choose any audio file on your device. To personalise your ringtones, go to **Settings > Sound > Ringtone**.

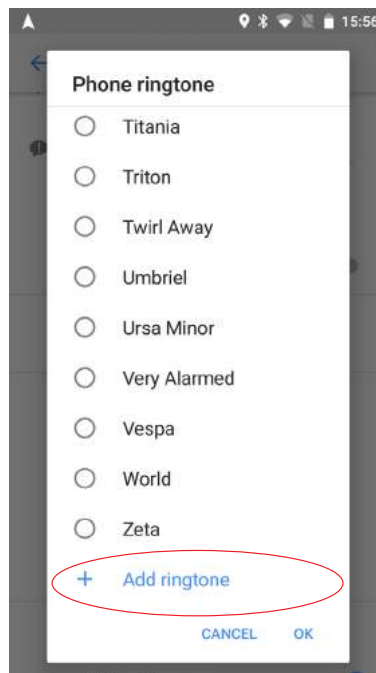

In this section you can configure the alarm tones by going to **Advanced > Default alarm tone** and selecting your song of choice from music that you have previously added to any of the internal memory folders.

Here you will also find **Do Not Disturb**. You can configure the priority of your notifications and create automatic rules. Rules are used to set 'do not disturb' times or events according to your personal circumstances. Tap the Settings cog icon in quick settings to access this option directly. On selection, three options display: **Silent, Alarms Only, and Priority interruptions only**. If the **Do not disturb** mode is set to **Total silence** or **Alarms only**, the notification LED will not work.

An easy way to access the sound settings is via the volume adjustment buttons located on the side of your device. Pressing the bottom half of the volume button a few times lowers the volume until it reaches vibration mode. Pressing it one more time activates the **Do not disturb** mode (Alarms only). Barring alarms, this will totally silence the device. Tapping the **✓** icon in the upper right corner provides access to the rest of the volume controls.

Storage

Two new ways to manage storage have been added to this section:

1. A **Storage manager** which enables us to quickly and conveniently free up space provides access to the list of programs by categories, showing both the space being occupied and their corresponding files, so that the files can be selected and deleted effectively.
2. Using the **Free up space** button, we can access the device's memory and multimedia content backups, and delete the most recent documents.

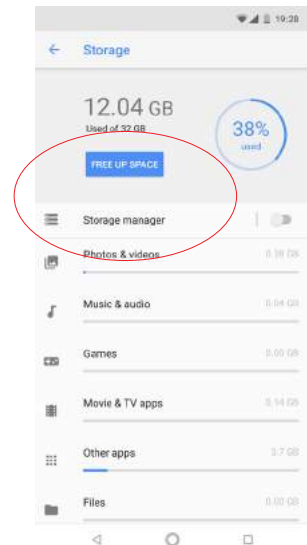

To free up space you can also delete cached data manually by going to **Settings > Storage > Other apps > selecting the app (organised by size) > Clear cache**.

Security and Location

The security and location options are grouped into this section.

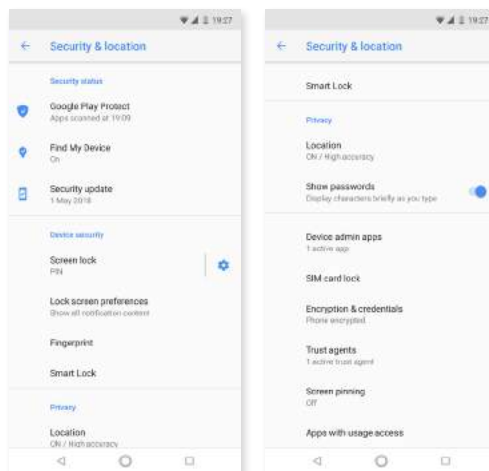

At the top are the options relating to the General security status:

Google Play Protect: Check regularly for harmful behaviour in your apps and on your device.

Find my device: This app helps you to locate your device remotely and to protect your data if the device is lost.

Security update: This section shows the latest security patches that have been installed. We can press on it to see if a new version is available.

DEVICE SECURITY

Screen security, the type of screen lock (none, swipe, pattern, PIN or password) and the SIM card lock can be set in this section.

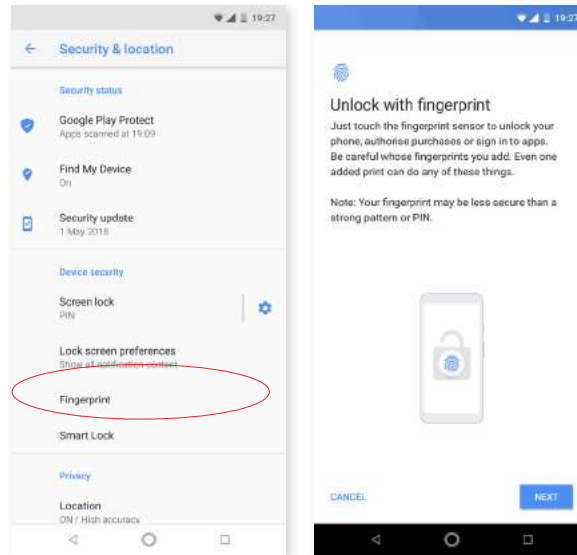

If you haven't already done so on starting your device for the first time, you can now add a **Digital fingerprint** to unlock your telephone, authorise purchases or sign in to apps. Any digital fingerprint that you add can perform these actions. An assistant will guide you through the fingerprint setup.

The **Smart Lock** option is an intelligent screen unlocking system allowing you to add devices, a face, or trusted sites in such a way that your smartphone does not ask you for the password as long as the conditions are met (for example, connecting to a smartwatch or Bluetooth connection in your car, when identifying your face, at home, or at work). Trusted places can be easily added by dragging the marker on the map or searching for the name of the location.



To successfully register your fingerprint you need to place your finger on the sensor several times making small adjustments to the position of your finger each time.



Another screen locking method needs to be configured before you are able to use your digital fingerprint.

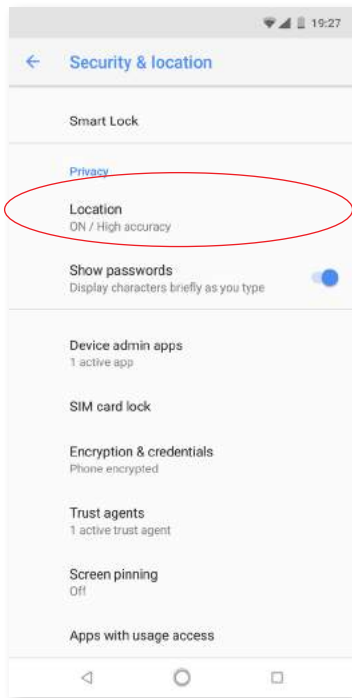

PRIVACY

If you enable **Location** tracking you are allowing those apps that request permission to access your location (pre-installed navigation maps).

There are two ways of calculating your location: **GPS satellites** and Wi-Fi and mobile network location.

In the Mode section you can choose from:

- High accuracy: determines your location using GPS, Wi-Fi and mobile data networks.
- Battery saving: determines your location using only Wi-Fi and the mobile network.
- Device only: determines your location using GPS only.

In the **Location services** menu you can access the Google location history and enable Qualcomm® IZat™ hardware accelerated location.

Under **Settings > Security and location > Location > Recent location requests**, you will find a list of apps that have requested access to your device's location and the amount of battery they used.

You can also improve the location by configuring the options for **Wi-Fi** and **Bluetooth scanning** via **Settings > Security and location > Location > Scanning**.

Users and accounts

From here, you can share this device with other people by creating more users, selecting the email accounts that you want to sync and adding any emergency information as appropriate. This information was previously separated in Nougat.

Accessibility

This section continues to offer certain system services to facilitate the accessibility of the device, such as large text, TalkBack, use physical buttons as virtual ones, speak passwords, quick boot, etc. The options are now regrouped into categories.

ACCESSIBILITY SCAN

Accessibility Scan enables users with severely limited movement (such as cerebral palsy, motor neuron disease or tetraplegia) to use devices with ease. Simply place the device on a support (a bed, table, wheelchair, etc.), connect it to a peripheral in close proximity to a more mobile part of the body and open the application. This will enable the user to easily browse the internet via presses on the peripheral.

Its operation is based on the interaction of two Cartesian axes. A tap is produced where these axes intersect on the screen. In addition, all usual interaction with the device can be performed by way of a pop-up Navigation Menu.

To see basic instructions on Accessibility Scan, go to **Accessibility Scan > Settings > Tutorial**. The tutorial shows you how to scan your system in three easy steps:

1. The first step shows how to tap on an item on the device's desktop using axis scanning.
2. The second step demonstrates how to use the main menu or sub-menus, which provide access to all the device's interactive features.
3. Lastly, there is an explanation on how to temporarily disable the scanning system and switch over to **Assistant mode**, which provides standard device usage

System

Captions: customises the captions. Standard options are:

Language: set the language in which captions are to be displayed.

Text size: set the size of the caption text.

Caption style: customise the style and colour of the caption text.

Google

Aspects relative to your account and services can be configured in this section. Among the options here are **Nearby** (it uses the device's sensors to connect via Wi-Fi or Bluetooth with other devices in a radius of 30 metres) and Set up nearby device (serves to transfer a device's configuration to another, downloading the Google account data via Wi-Fi and sending it by Bluetooth to the new device).

To use the Google Assistant, simply press and hold the **Home** button  (in the centre).

System

The general device settings that affect the entire device appear in this section, such as **Language and input**, **Gestures**, **Date and time**, **Backup**, **System updates**, **Scheduled Power On and Off**, **About phone** and **Reset options**. The latter offers the additional option of separately resetting the network settings (mobile, Wi-Fi or Bluetooth), the app settings or a total factory reset.



LANGUAGES AND INPUT

The system language, automatic spell checker and personal dictionary can be configured in this section. You can also configure the keyboard, text input methods, voice typing and pointer speed.

It is now possible to add more than one language preference. Do this via **Settings > Languages and input > Languages**, then select **Add a language**. A list of available languages will appear. Choose the desired one and it will be added to your preferences.

You can as many languages as desired to your preference list by following this process so that when an app does not offer its content in the main language, it will use those that you have added to the list in order of preference. Chrome will not request to translate web pages in languages included in the preference list. In addition, it will show search results in the said languages.

The language that you place in first position will be the main language of your device. Hold the icon  (to the right of the language) down in order to move a language up or down the list. The higher its position in the list, the higher its priority.

To remove a language, tap the  icon and **> Remove**, then select the language you wish to remove and tap the  icon (located in the top right corner of the screen).

GESTURES

A new sub-menu called Gestures now forms part of the **Settings** menu. The following functions can be enabled here:

- **Camera shortcut:** double-pressing the power button opens the camera.
- **Pick up the phone to check it:** the screen wakes up when the device is picked up.

DATE AND TIME

Automatic date and time: sets the time automatically based on location information or the mobile network. Disabling this option will enable manual date and time configuration.

Automatic time zone: uses the network-provided time zone when enabled. Disabling this will enable the Select time zone option, which must be manually set.

Use 24-hour format: enables/disables the 24-hour time display format.

BACKUP AND RESET

Here you can back up your app data, Wi-Fi passwords, and other settings on the Google servers. To back up your data, a Google account must be set up on your device. Ensure to enter all your Google account data in the initial setup wizard. In this way, when restoring a backup saved on the Google server, all your apps and their corresponding data will be restored.

SYSTEM UPDATE

Your device will periodically check for new updates to the operating system, which generally include performance improvements or additional features for your smartphone. From this section, you will be able to check if your system is up to date, as well as the date and time of checking.

SCHEDULED POWER ON AND OFF

Puedes configurar de forma automática la hora a la que se enciende o se apaga tu dispositivo.

RESET OPTIONS

From this section you can **Reset the Wi-Fi, Mobile networks** and **Bluetooth** settings or simply **Reset App preferences**.

You can also **Delete all data** and carry out a **Factory data reset**, as well as erasing any remaining DRM (digital content protection) licences after having deleted their associated files.



Restoring factory default settings will erase all data stored on the internal phone memory and all user-installed apps and programs. Before restoring the telephone to factory default settings it is advisable to make a backup of all settings and multimedia files.

ABOUT PHONE

This section displays the status of the device (battery, SIM data, serial number, etc.), legal information, Android version, model number, baseband, kernel versions and the build number.

Multimedia

Camera

Your smartphone has a dual front cameras and a rear one. To access them go to **Apps menu > Camera**. To switch from one camera to another (front or rear), press on the icon  at the bottom right of the screen. Each tap toggles between the front and rear cameras. Both can be used for still shots and video recording. The rear camera also has autofocus.

Swipe left or right to change modes, or just tap directly on the desired one. Either way you will alternate between **Manual, Auto and Panoramic**.

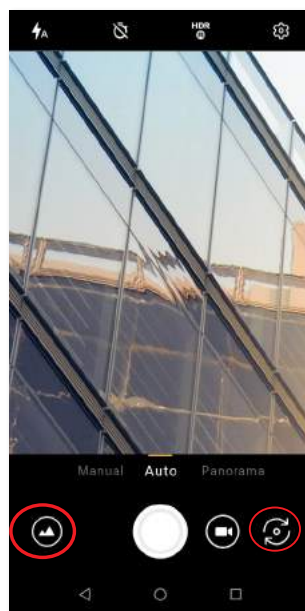

Press  or  to shoot, or depending on which option you have selected.

To **zoom** when taking photos or video, use a pinch gesture on the preview before taking the shot. Alternatively, use the volume buttons (requires previous configuration in the settings).

To access the Photos app and view the last shot taken, tap the circular thumbnail in the bottom left corner. Go back to the camera by tapping the  icon in the top left corner.

General Settings

The general settings can be accessed from the photo camera or from the video camera by tapping the  icon located in each mode's setting menu (except panoramic).

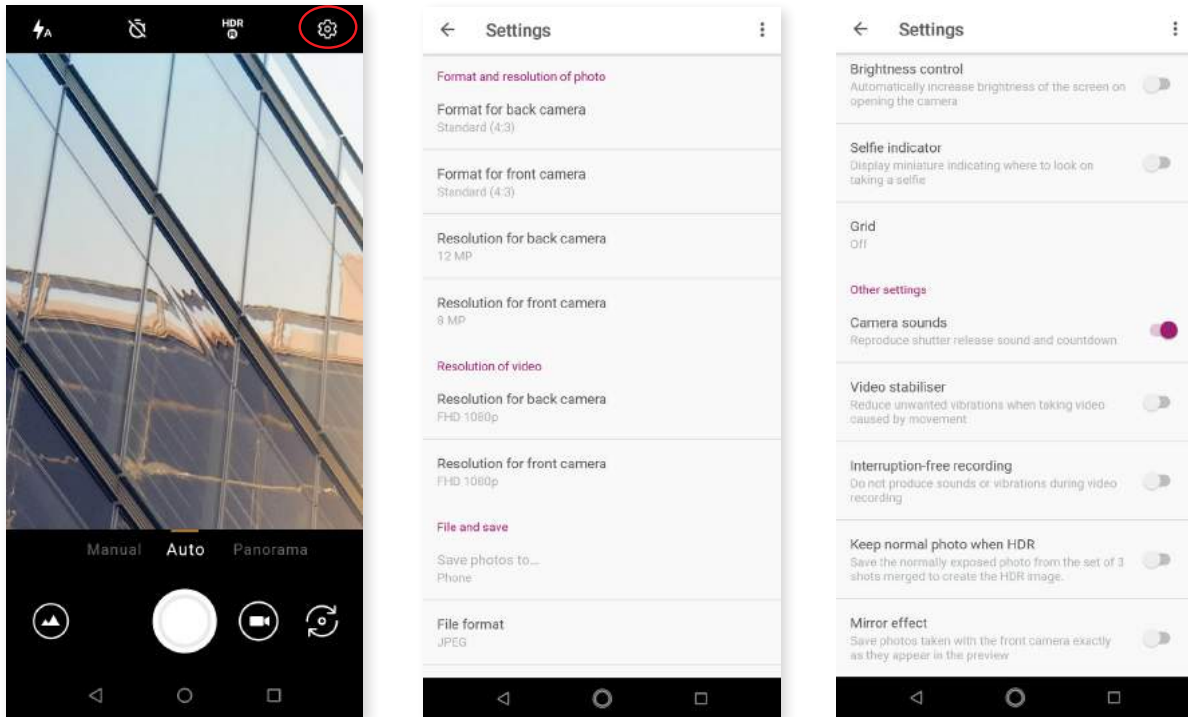

PHOTO FORMAT AND RESOLUTION

Format for the rear camera: sets the image size. Choose from Standard (4:3) or Full HD (16:9) or Full HD Plus (18:9).

Format for the front camera: sets the image size. Choose from Standard (4:3) or Full HD (16:9) or Full HD Plus (18:9).

Resolution for rear camera: sets the image quality. Values ranging from 2 MP to 13 MP are available.

Resolution for front camera: sets the image quality. Values ranging from 2 MP to 5 MP are available.

VIDEO RESOLUTION

Resolution for rear camera: sets the video quality. Values ranging from HD 720p to FHD 1080p are available.

Resolution for front camera: sets the video quality. Values ranging from HD 720p to FHD 1080p are available.

FILE FORMAT AND STORAGE

Store photos as: choose whether to save images on the telephone or the microSD card if one is in use.

File format: choose either JPEG or JPEG+DNG format.

JPEG quality: choose High, Medium or Low image quality.

Geolocation: enabling this option will geotag the multimedia file when it is created.



To access the microSD and location, you must grant the requested permissions.

VOLUME KEY FUNCTIONS

In camera mode: assigns a function to the volume keys in camera mode. Choose between Take photo, Volume or Zoom.

In video mode: assigns a function to the volume keys in video mode. Choose between Take photo, Record video, Volume or Zoom.

SCREEN SETTINGS

Brightness control: Sets the screen brightness to maximum level in case you have disabled it. This makes it easier to take photos and record videos. If you have previously enabled Adaptive brightness, it will function by adapting to the light available.

Selfie frame: Shows a miniature portrait indicating where you need to look to take a selfie.

Grid: Shows a grid to guide you in taking pictures more effectively. It is disabled by default. You can personalise the grid type: Rule of thirds, Golden ratio or 1:1.

OTHER SETTINGS

Camera sounds: enables/disables the shutter and countdown sounds when shooting.

Video stabilizer: reduces vibration while recording a video.

Record without interruptions: Sounds and vibrations are disabled during the recording.

Save normal photo in HDR: Saves the photo with normal exposure from the three pictures taken to generate the HDR image.

Mirror effect: Save the photos taken with the front camera as they are shown in the preview.

You can **Restore settings** (return to factory default settings) by tapping on the icon  located in the top right corner.



To access Record without interruptions, you will need to enable Do not disturb mode in Camera when permission is requested.

Camera Mode

By tapping the screen in Camera mode, a bar will appear by default enabling you to manually adjust the exposure. Pressing the screen locks the focus, which allows the selection of an exposure that is better adapted to the scene, thus optimising the photograph's quality. Tap the same point again and a yellow circle will appear, indicating that the focus is now locked.

The camera can be used in either **Manual, Auto or Panoramic mode**.

AUTO

Following is a brief explanation of the icons in the **Auto** mode menu:

 Choose between automatic flash, flash on or flash off.

 Enables or disables the countdown timer. A delay of either 3 or 10 seconds can be selected.

HDR High Dynamic Range is a photography mode that increases a photograph's dynamic range without loss of detail. It does this by taking three shots with different exposures and superimposing them into one image. HDR mode is not compatible with the continuous shooting option or the flash.

 Provides access to the camera's general settings.

MANUAL

In addition to the icons already explained in Auto, the extra settings for **Manual** mode are covered briefly below:

 Choose between automatic or manual focus.

WB Adjusts the white balance. There is a variety of lighting temperatures to choose from. The default setting is Auto.

ISO Selects the sensor's level of sensitivity in accordance with available lighting conditions. Choose Auto mode or manually set a value from 100 to 1600.

 Adjusts the exposure time manually.

 Manually regulates the exposure.

PANORAMIC

When this mode is enabled, a progress bar appears indicating the direction you can move your phone.

To obtain an optimal result try to keep the device as straight as possible while panning. For guidance, a white arrow appears on the progress bar. This arrow will be thrown off course as a warning if you are not following the guide and it will indicate the direction you should follow so that the takes fit together seamlessly.

The camera will automatically end the shooting and save your panoramic photo at the end of the progress bar. The panoramic capture can be interrupted at any time by pressing the **Stop** button.

Video Mode

When using the video recording function, you can select from the following modes:

Fast Motion, Video, Time Lapse.

FAST MOTION VIDEO

This mode enables video recording in fast motion. This visual effect is achieved by recording a scene at a lower rate of images per second than the projection speed. When these sequences are played back at a normal rate of images per second, they appear to be playing in fast motion. Following is a brief explanation of the menu icons:



Enables/disables the flashlight.



Enables or disables audio recording.



Sets the recording speed. Choose between 2 and 4 times quicker.



Accesses the general settings of the camera.

VIDEO

Below is a brief explanation of the **Video** menu icons:



Enables/disables the flashlight.



Enables audio recording.



Provides access to the camera's general settings.

TIME LAPSE

This mode allows a scene to be captured as it changes over time. It can then be played back at normal speed but with a fast-motion effect. You can enable the time-lapse feature and set the time interval for capturing your images. Each second of time lapse video requires 30 frames. The faster that events move in the scene you are recording, the shorter the time interval you should use. Following is a brief explanation of the menu icons:



Enables/disables the flashlight.

1s Choose the capture interval for your photos.



Accesses the general settings of the camera.



In Fast mode, the quality of the recording will be FHD 1080.





Photos

To view the images and videos stored on your device use the **Photos** app located in the apps drawer.

The main screen of the **Photos** app lets you browse the images and videos stored on your device. Tap on an image or video to view it.

You can also access the image gallery after taking a photograph or recording a video. To do this, tap the circular thumbnail  of the last photograph or video. It is located in the bottom left corner.

While viewing an image the following functions are available:

- Tapping the menu button or the  icon shows a list with the following options: **Slideshow, Set as, Print, Delete from device and Help/Send suggestions.**
- Tapping the  icon will show a list of frequently used contacts together with the most common applications used to communicate with them.
- Tap the  icon to open the image editor in order to apply filters, add frames, adjust brightness, etc.
- Tap the  icon to display details about the photograph or video.
- Tap the  icon to delete a selected photograph or video.

To zoom in on an image, simply double-tap the screen. Double-tap again to zoom back out. The pinch gesture can also be used. Zoom in by spreading your fingers apart and zoom out by bringing them together.



By default, Android does not allow new folders to be created or images to be moved from one folder to another. However, free third-party apps are available that perform these functions.

Apps

To open the list of applications, simply swipe from the bottom of the screen or tap the icon (located just above the dock). The apps drawer contains an alphabetically ordered list of preinstalled and downloaded apps.

The apps are arranged vertically. Scroll the list up or down with your finger. Long-pressing the sidebar displays the first letter of the applications making them easier to find. A search bar has also been included to help locate apps faster. When using this method to look for an app, you are also offered the possibility to access the [Play Store](#) by tapping on **Search for more apps**.

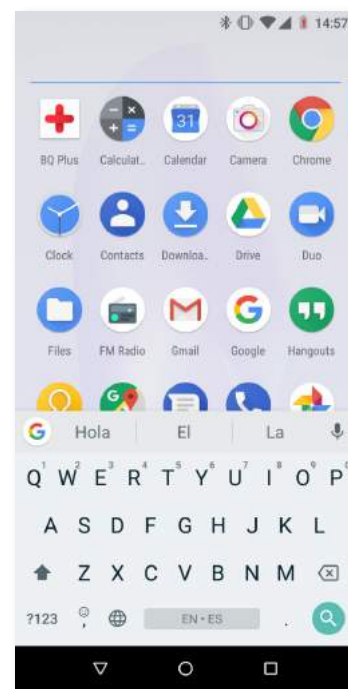
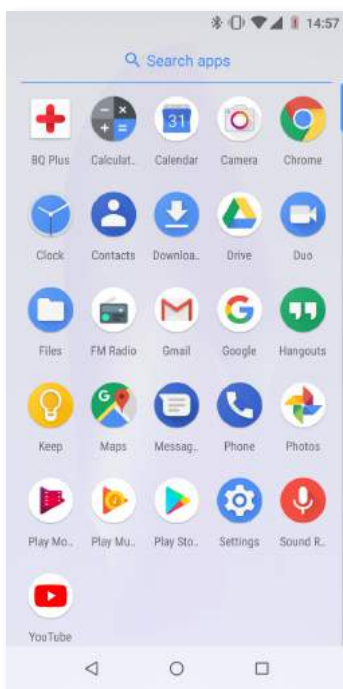

Individual Permission for Apps from Unknown Sources

To download apps from an alternative store or from a website, you must first configure the system to accept the installation of apps from unknown sources. To authorise the downloads, go to **Settings > Apps and notifications > Advanced > Special access > Install unknown apps**.

For greater security, permissions are now individual. As with previous version, only few specific apps have the authority to install apps from unknown sources and not the entire phone.



Only install this type of app from trusted sources.

Play Store

Your smartphone comes with a preinstalled app store that offers you access to all types of programs, games, music, films, books and more. Downloads are arranged into logical categories to help you find exactly what you are looking for.









Important: Be aware that not all downloads are free and additional costs may be incurred. When downloads are not free, the price will appear beside the app description. To avoid unexpected charges, you will be asked to confirm before downloading.

Chrome

You can browse the Internet using various tabs and URLs simultaneously. The amount of active tabs is indicated by the number inside the square icon found in the upper right corner. Tapping this allows you to select one of the active tabs or open a new one. On opening a new tab you can manually enter a URL into the blank space at the top, or use the suggestions based on the most frequently visited pages that appear in the centre of the screen.

To close a tab, simply press the tab icon and then press **X** or simply swipe the tab that you want to close.

Press the menu icon , to access the following options:

- **Go back or forward**   : Enables you to return to previously visited pages or move forward through them.
- **Add bookmark/favourite**  : marks a page as a favourite so that it can be easily accessed later. Your bookmarks can be organised by folders.
- **Download**  : a file or image can be downloaded from the current webpage in order to view it while offline.
- **Information**  : provides information about the current web page.
- **Reload page**  : refreshes the content of the current page.
- **New tab**: opens a new tab. This allows simultaneous browsing of different websites.
- **New incognito tab**: browsing history is not recorded when using these tabs.
- **Bookmarks**: access the list of saved bookmarks.
- **Recent tabs**: access the list of recently closed tabs and restore them if desired.
- **History**: shows a chronological list of visited websites (the most recent ones first).
- **Downloads**: access the list of downloaded files.
- **Share**: lets you share the current webpage with other users.
- **Find in page**: Search for text in the current page.
- **Add to home screen**: Select a website to appear as your home page on opening the browser.
- **Request desktop site**: ticking this box enables you to view a website exactly as it would appear on a computer, disregarding versions specifically for mobile devices.
- **Settings**: provides access to basic and advanced browser settings.
- **Help and feedback**: view feedback from other users, leave your opinion and consult the help documentation.

Calendar

Manage your daily tasks with the **Calendar** tool and sync them with your email account. This enables you to share appointments, meetings and events with your contacts. It also enables you to set up reminder alerts and notifications so that you never miss an appointment. The app also allows you to sync your calendar so that it can be viewed from any other mobile device.

To create a new event tap the **+** icon in the bottom right corner. You can specify the date and time of an event, the location of a meeting and even the people invited, as well as enable or disable alerts, add an event description and even set the availability status your contacts will see while you are in the meeting.

Maps and GPS Navigation

Your smartphone includes the **Maps** application which lets you find your current location (enable GPS for greater accuracy), view satellite imagery and even see actual pictures of a given location. Select the navigation option to have the device guide you to your destination from your current position, whether travelling on foot or by vehicle. This app features a service which locates affiliated companies and establishments.

Please note that this information (including the maps) is not preloaded onto your device, which means a data connection will be required whenever navigation is used. Additional charges may be applied according to your with your mobile network operator's tariffs.

BQ Plus

BQ offers the possibility of taking out insurance for your device. This can be done within 15 days from first turning it on. More information about its coverage and terms is available at bq.com/bq-plus

Email

Setting up a Gmail account

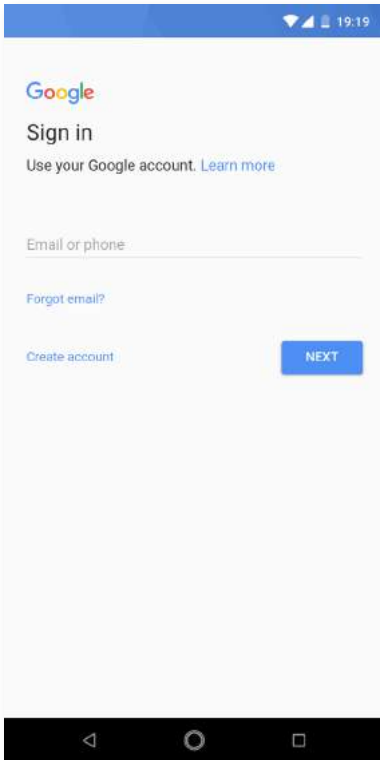

You will need to set up a Gmail account the first time you switch on your smartphone or after doing a factory reset (this deletes all data).



You may use an account that you already have. Alternatively, the system will help you create a new one. Please note that a Gmail account is required to access part of the device's functionality. Some apps will not be available until the said account has been correctly set up. Make sure that Gmail is kept updated to avoid any issues.

From within Gmail (found in the Apps drawer) you can access your inbox and adjust settings such as how emails are displayed, how they are read or replied to and how notifications are received.

Furthermore, several different accounts can be grouped together allowing simultaneous reception of email from all of them.

Any account is compatible with the Gmail app.

Sending an email

1. Open the Gmail app and tap the **Compose**  button.
2. Enter the recipient's email address, fill in the subject box and write the message.
3. Tap the **Send** button .

Add attachments by pressing the icon .

Replying to an Email

Reply to emails using any of the following three options:

- **Reply:** Only the person that sent the message will receive the reply.
- **Reply all:** All the users listed as recipients of the email will receive a copy of the reply.
- **Forward:** You can forward a copy of an email to a person other than the sender(s).

In some email clients, files attached to a previously received email only remain attached when forwarding.

Calculator

You will find various tools on your smartphone, such as a practical calculator, which allows you to make basic as well as scientific or advanced calculations. Only the basic options are shown when the app is launched. To access the advanced options, either swipe the screen to the left or rotate the device.

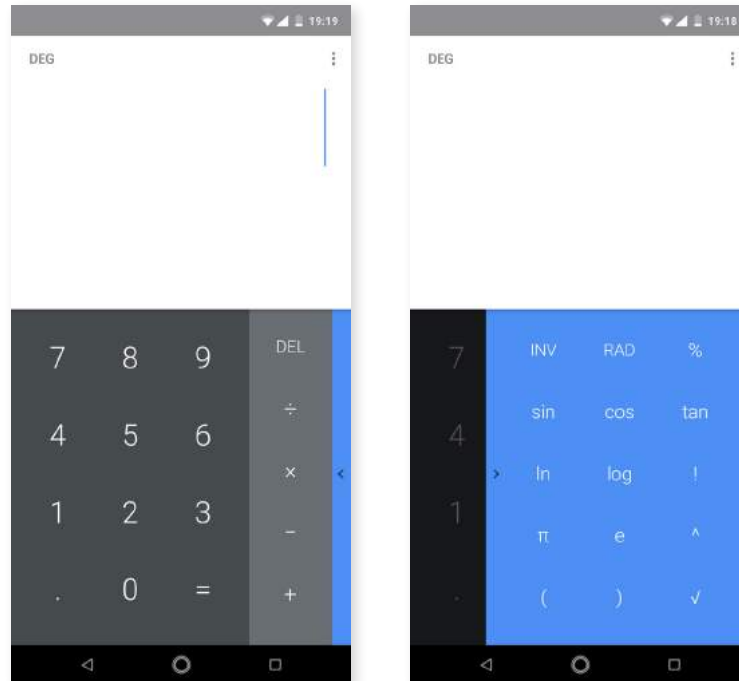

Clock

Your device comes with a useful **Clock** that has various functions.

The first tab lets you easily manage your **Alarms**. Set more than one alarm at a time, assign them names, confirm if an alarm is to repeat or not, decide which days it is to go off, the tone it should use and enable/disable vibration.

Delete and create alarms as often as you like. To enable or disable an alarm without deleting it, simply move its corresponding slider to the left.

The second tab shows the time in any part of the world, the third tab has a programmable timer, and finally, the fourth tab contains a practical stopwatch with lap functionality.

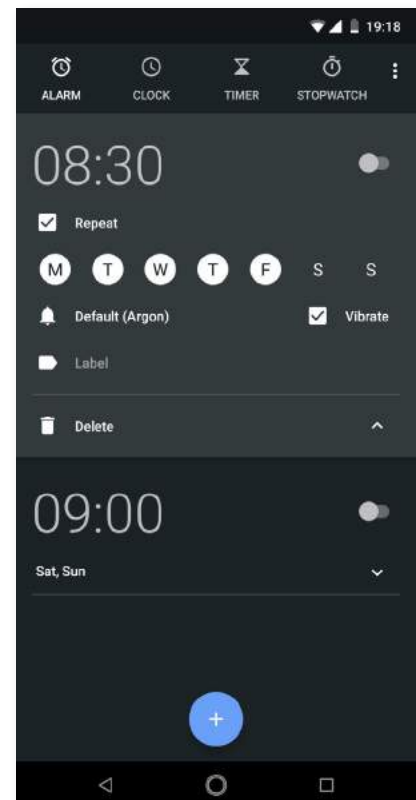

Useful Advice and New Features

OTA Updates

OTA stands for *Over the Air*, which refers to the way that firmware updates are sent to your device, namely, through a data connection. There are no complex update procedures and minimal user intervention is required.

Your device periodically checks for new updates to the operating system. These usually include performance improvements or additional features for your smartphone.

You will be notified via a pop-up window when the system detects that an update is available. Confirmation to install it will be requested. We recommend using a Wi-Fi connection to download the update package.

For speed and convenience, the system will guide you through the entire installation process. You can also check for updates manually by going to **Settings > System > System updates**. A message will appear to tell you that the system is searching for available updates. If one is available the installation process will occur as described above.

Auto-fill service

It comes with an autofill system inherited from Chrome. This means that if you save your data when you fill in a form, it will automatically be filled in the fields on new forms, such as name, address, etc.

You can change the settings for this feature via the **Autofill service** within **Settings > System > Language and input**. By default, it uses any data already saved to your Google account in Chrome via Smart Lock.

Smart text selection

The text selection feature in Android Oreo now detects what type of content we copy and gives us the option of writing an email, calling or finding the address in Google Maps, according to whether we are copying text from an email, a phone number or a postal address.

BQ Launcher



The **Home screen** is also slightly different in this new version of Android. The apps drawer can still be accessed by pressing the icon (on the lower bar, where the shortcut to various apps is located). The new feature with Oreo, which was not available in Nougat, is that now you can swipe upwards from anywhere on the screen to access it, improving the user experience.

Progressive installation progress bar

On installing an app in Android Oreo, an installation bar appears showing the progress in real time.

New emojis

The traditional Android emojis showing the little balloons with a character inside give way to the latest emoticons which are recognisable by everyone. They take on a circular form, similar to the ones used by the majority of apps.

Compress files

Android now allows files to be compressed into ZIP format via the File explorer. To do this, select the files and then select the **Compress** option from the menu.

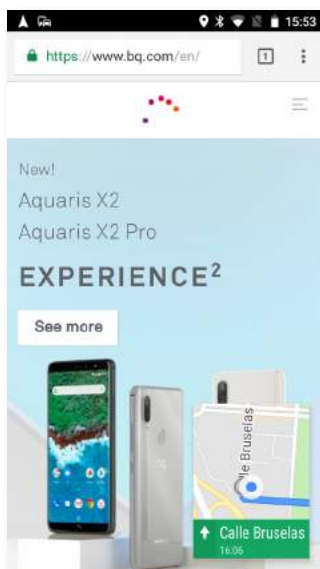
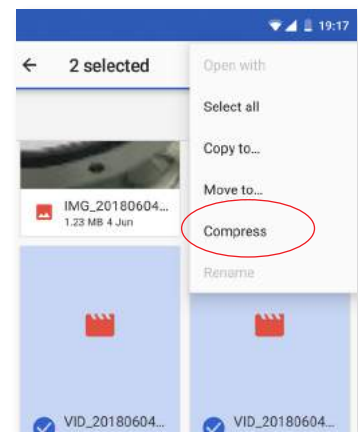

New Picture-in-Picture option (PiP)

PiP is a new type of multi-window mode that allows us to continue video playback and video calls or navigation while another app is in use, making it possible to view content while doing other activities.

To enable this floating window, simply put the video in full-screen mode and press and hold the **Home or Start button** (in the centre). You can move it around and reposition it to your liking.

To find out which apps are compatible with this new option, go to **Settings > Apps and notifications > Advanced > Special access > Picture-in-Picture**. You will see a list of all the apps that can be used in PiP mode.



This option must be supported by the app.



The PiP mode only functions in Google Maps navigation mode (when the route has already been started) and in the messaging app during video calls, for example using Google Duo.

Appendices

Appendix A: Technical specifications.

Access all the technical information relative to your device by visiting this link and selecting the corresponding model: <http://www.bq.com/en/smartphones>

Clicking on Specifications will show relevant information, such as:

- Dimensions and weight.
- Screen.
- Processor.
- Interface.
- Internal memory.
- Battery.
- Camera.
- Audio.
- Connectivity.
- System functions.
- Compatible formats.
- SAR values.

Appendix B: Cleaning and safety.

CLEANING

Before cleaning your device, switch it off and disconnect all system and power cables. Make sure the screen is completely dry before reconnecting any cables and switching on the device. Do not apply any cleaning sprays or liquids directly onto the screen or casing.





Screen: use a clean, soft, lint-free cloth to remove dust and dirt from the screen. To remove fingerprints and stains use a cloth with a mild cleanser.

Casing: use a soft cloth slightly dampened with a mild cleaning solution. Rinse the cloth in clean water, wring it out thoroughly and wipe the casing to remove any residual detergent.

SAFETY

To reduce the risk of an accident, follow these safety instructions:

- Do not use power cables, connectors or plugs that are damaged or have loose wiring. Do not bend or damage the power cable. Do not touch the power cable with wet hands. Do not pull on the cable to unplug the charger.
- The device can be used while it is charging, however, this will prolong the full charging process. Avoid handling it with wet hands during charging.

- Do not subject the charger to impact. Do not charge the battery with a charger that has not been approved by the manufacturer.
- Do not use the device during electrical storms.
- Do not handle lithium batteries that are damaged or leaking.
- Do not use the device near a pacemaker. If possible, avoid using it at distances under 15 cm from the pacemaker as it could interfere with the pacemaker's operation. During a call, hold the device on the opposite side of the implant .
- Do not use the device in a hospital or near medical equipment that may be susceptible to radio frequency interference.
- If you regularly use medical equipment, make sure it is protected against radio frequency interference. If you use a hearing aid, consult the manufacturer with regard to potential interference.
- In potentially explosive environments, turn off the device. Always observe regulations, instructions and warning signs .
- Do not use the device in refuelling areas (petrol stations) or close to flammable and/or explosive chemical products .
- Do not store or transport flammable liquids, gases or explosive materials in the same compartment as the device or any of its parts or accessories .
- Switch off the device upon boarding an aeroplane. The electronic components of a motor vehicle may malfunction as a result of radio frequency interference from the device.
- Avoid placing the device near the abdominal and genital area, especially in the case of children, adolescents and pregnant women .
- Prolonged exposure to high levels of sound pressure may cause permanent damage to hearing. It is recommended that you do not wear headphones while cycling, running or walking through areas with heavy traffic or excessive noise .
- Using the phone while driving. Some car manufacturers prohibit the use of mobile telephones in their vehicles unless a hands-free kit and external antenna are installed. Ask the vendor of your vehicle whether your mobile phone or hands-free Bluetooth kit will interfere with the car's electronic systems. Always pay full attention to the road and respect local laws and regulations on the use of wireless devices when driving.
- When the device is using geo-positioning information, interruptions or malfunctions may occur causing increased dependence on the network. Note that functionality may be reduced or obstructed in certain places such as inside buildings or in areas close to buildings.
- Use the GPS feature with caution and ensure that it does not cause distraction while driving. Mundo Reader, S.L. does not claim or in any way guarantee the accuracy of any location-based information.
- Emergency calls: Being able to make calls cannot be guaranteed under all conditions. Never place your trust solely in a mobile telephone for making emergency calls. With certain mobile networks, certain network services or certain functions enabled and in certain areas, it may not be possible to make a call.

- Antenna: Using an antenna other than that supplied by Mundo Reader, S.L. may damage the telephone, impair its performance and generate SAR levels (see Appendix C on the next page) that exceed the limits established by law. Do not cover the antenna with your hand as this affects call quality and power consumption, and may shorten both talk and standby times.
- Wi-Fi (WLAN). This device can be used in all European countries and Russia. Frequency intervals that oscillate between 5150 Mhz and 5350 Mhz are limited to inside spaces. Consult your device's Wi-Fi bands in the product specifications.



- Using the device under good reception conditions reduces the amount of radiation received. The level of reception quality is indicated by the coverage icon ▲.
- Aeroplane mode. Use of Bluetooth and WLAN may be prohibited on aeroplanes and in other places where radio transmissions are not permitted. In the aforementioned places, ask permission before enabling Bluetooth or WLAN, even in Aeroplane mode.
- This smartphone is designed to operate within a temperature range of -10 to 50 °C. As this is a high-technology device, extreme climatic conditions have a negative impact on its operation. We advise against using it in ambient temperatures under 0 °C or above 40 °C. Doing so may cause malfunctioning or damage the device (or even cause explosions in more extreme cases). It is also inadvisable to use it continually at the limits of this range (for example, at internal or ambient temperatures under 0 °C) or in adverse climatic conditions as this may cause performance drops that temporarily affect device functionality and battery life.

Appendix C: Disposing of this Product Correctly



(Electrical and electronic waste).
 (Applicable within the European Union and in European countries with selective waste collection systems).

The presence of this symbol on the product, accessories or accompanying informative material indicates that, at the end of their service lives, neither the product nor its electronic accessories (charger, cables, etc.) are to be disposed of with household waste.

To prevent any damage to the environment or human health, separate these products from other types of waste and recycle them correctly. This encourages the sustainable reuse of material resources and avoids the depletion of finite ones.

Domestic users should contact the vendor that they purchased the product from or the relevant local authorities to find out how and where they can recycle this product safely, without harming the environment.

Business users should contact their supplier and consult the terms and conditions in the purchase contract. This product and its electronic accessories must not be disposed of with commercial waste.

Appendix D: Information regarding maximum transmission power and frequency bands.

To access a mobile network, your device connects to a frequency band, that is, a frequency range in the electromagnetic spectrum. Either 2G, 3G or 4G mobile data speeds are available depending on the country and the band. This device complies with the 3GPP (3rd Generation Partnership Project) standard regarding maximum transmission power and frequency bands. These are the limit values for each band in which the device operates:

Frequency bands	Maximum power Aquaris C
GSM900	34 dBm
GSM1800	31 dBm
WCDMA Band I	24 dBm
WCDMA Band VIII	24 dBm
LTE Band 1	24 dBm
LTE Band 3	24 dBm
LTE Band 7	24 dBm
LTE Band 20	24 dBm
2.4 GHz WLAN	17.42 dBm
5.2 GHz WLAN	14.86 dBm
5.3 GHz WLAN	14.85 dBm
5.5 GHz WLAN	14.92 dBm
5.8 GHz WLAN	12.67 dBm
Bluetooth v3.0+EDR	9.95 dBm
Bluetooth v4.0/4.1/4.2 LE	1.11 dBm
NFC	-10.97 dBuA/m at 10 m (Transmitter H-field Output power)

Appendix E: Information on Exposure to Radio Waves and SAR (Specific Absorption Rate)

The design of this smartphone complies with the current regulations governing exposure to radio waves. These regulations are based on scientific guidelines that include safety margins designed to ensure the safety of everyone, regardless of age or state of health. The guidelines on exposure to radio waves use a unit of measurement known as the Specific Absorption Rate, or SAR. SAR tests are carried out using standardised methods, with the mobile telephone transmitting at the highest certified level of power on all the frequency bands it uses.

The maximum SAR level recommended by the ICNIRP (*International Commission on Non Ionizing Radiation Protection*) is 2 W/kg, measured on 10 grams of tissue.

The highest SAR levels recorded for this phone are as follows:

	Aquaris C
Auditory use (0 mm)	1.492 W/Kg (10 g)
Use at a 5 mm distance from the body	1.482 W/Kg (10 g)

This device complies with the guidelines on exposure to radio frequency both when it is used in the normal position next to the ear and when it is positioned at least 5 mm away from the body. This device requires an adequate network connection in order to send data files or messages. On certain occasions, the transmission of data files or messages may be delayed until an adequate connection becomes available. Until the transmission has been completed, make sure you follow the instructions on the separation distance mentioned above.

Appendix F: Federal Communication Commission Interference Statement

This device Aquaris C complies with part 15 of the FCC Rules. Operation is subject to the following two conditions: (1) This device may not cause harmful interference, and (2) this device must accept any interference received, including interference that may cause undesired operation.

This device has been tested and found to comply with the limits for a Class B digital device, pursuant to Part 15 of the FCC Rules. These limits are designed to provide reasonable protection against harmful interference in a residential installation. This equipment generates, uses, and can radiate radio frequency energy, and, if not installed and used in accordance with the instructions, may cause harmful interference to radio communications. However, there is no guarantee that interference will not occur in a particular installation. If this equipment does cause harmful interference to radio or television reception, which can be determined by turning the equipment off and on, the user is encouraged to try to correct the interference by one or more of the following measures:

- Reorient or relocate the receiving antenna.
- Increase the separation between the equipment and receiver.
- Connect the equipment into an outlet on a circuit different from that to which the receiver is connected.
- Consult the dealer or an experienced radio/TV technician for help.



Operation on the 5.15 - 5.25 GHz frequency band is restricted to indoor use only. The FCC requires indoor use for the 5.15-5.25 GHz band to reduce the potential for harmful interference to co-channel Mobile Satellite Systems.

REGULATORY AGENCY IDENTIFICATIONS

For regulatory identification purposes, your product is assigned a model number of Aquaris C.

To view your FCC ID in your device you may also go to **Settings** > **About phone** > **Legal information** > **FCC ID**.

RF EXPOSURE INFORMATION (SAR)*

This device Aquaris C meets the government's requirements for exposure to radio waves.

This device is designed and manufactured not to exceed the emission limits for exposure to radio frequency (RF) energy set by the Federal Communications Commission of the U.S. Government.

The exposure standard for wireless device employs a unit of measurement known as the Specific Absorption Rate, or SAR. The SAR limit set by the FCC is 1.6 W/kg. Tests for SAR are conducted using standard operating positions accepted by the FCC with the device transmitting at its highest certified power level in all tested frequency bands. Although the SAR is determined at the highest certified power level, the actual SAR level of the device while operating can be well below the maximum value. This is because the device is designed to operate at multiple power levels so as to use only the power required to reach the network. In general, the closer you are to a wireless base station antenna, the lower the power output.

The highest SAR value for Aquaris C as reported to the FCC when tested for use at the ear is 1.00 W/kg (1g) and when tested for use close to the body, as described in this user guide, is 0.42 W/kg (1g). Body SAR measurements differ among device models, depending upon available accessories and FCC requirements.

While there may be differences between the SAR levels of various devices and at various positions, they all meet the government requirement.

The FCC has granted an Equipment Authorization for this model device, Aquaris C, with all reported SAR levels evaluated as in compliance with the FCC RF exposure guidelines. SAR information on this model device is on file with the FCC and can be found under the Display Grant section of www.fcc.gov/oet/ea/fccid after searching on FCC ID: 2AN87AQUARISC.

For body worn operation, this device has been tested and meets the FCC RF exposure guidelines for use with an accessory that contains no metal and be positioned a minimum of 10 mm from the body. Use of other accessories may not ensure compliance with FCC RF exposure guidelines. If you do not use a body-worn accessory and are not holding the device at the ear, position the handset a minimum of 10 mm from your body when the device is switched on.

Firmware version

BQ Aquaris C: 1.0.1_20180731-145

1.0

