

acer

User Guide



ICONIA TAB

© 2011. All Rights Reserved.

Acer ICONIA TAB User Guide

Model: A100 (Wi-Fi only models) and A101 (Wi-Fi+3G models)

First issue: 06/2011

Acer ICONIA TAB

Model number: _____

Serial number: _____

Date of purchase: _____

Place of purchase: _____

Table of contents

Table of contents

End user license agreement

Getting to know your tablet

Features and functions	5
Product registration	5

Setting Up

Unpacking your tablet	6
Getting to know your tablet	7

Using your tablet

Using the SIM card slot (only for Wi-Fi+3G models)	11
Charging your tablet	11
Turning on for the first time	12
Locking your tablet	13
Using the touchscreen	13
The Home screen	14
The onscreen keyboard	20
Editing text	22

Connecting devices to your tablet

Connecting to AC power	24
Inserting a microSD card (optional)	24
Connecting to a PC as a USB storage device	24
Connecting a Bluetooth device	25
Connecting to a television with HDMI	25
Connecting to the dock (optional)	26

Going online

Managing Wi-Fi connections	27
Browsing the Internet	27
Setting up Gmail (Google mail)	28
Composing an email	28
Setting up the Email application	29
Online applications	29

Acer content folders

Using the content folders	36
---------------------------------	----

Playing music and video

Multimedia playback	38
Media Server	42
Dolby Mobile	42

Managing contacts

Using the camera

Camera icons and indicators	46
Taking a photo	47
Shooting a video	48

Using a cellular data network (only for Wi-Fi+3G models)

Installing a SIM card	50
Adjusting connection settings	51
Internet sharing	52

Advanced settings

Sound	54
Screen	54
Putting your tablet in Airplane mode	55
Activating or deactivating connections	55
Adjusting Bluetooth settings	56
Connecting to a PC	56
Synchronization	56
Setting the date and time	57
Setting alarms	57
Changing language and text options	58
Managing applications	58
Updating your tablet's operating system	58
Resetting your tablet	58

Appendix

FAQ and troubleshooting	60
Other sources of help	61
Specifications	62
Safety	64

End user license agreement

IMPORTANT - READ CAREFULLY: THIS END USER LICENSE AGREEMENT ("AGREEMENT") IS A LEGAL AGREEMENT BETWEEN YOU (EITHER AN INDIVIDUAL OR A SINGLE ENTITY), AND ACER INC. INCLUDING ITS SUBSIDIARIES ("ACER") FOR THE SOFTWARE (WHETHER PROVIDED BY ACER OR BY ACER'S LICENSORS OR SUPPLIERS) THAT ACCOMPANIES THIS AGREEMENT, INCLUDING ANY ASSOCIATED MEDIA, PRINTED MATERIALS AND RELATED USER ELECTRONIC DOCUMENTATION WHICH MAY BE BRANDED "ACER" ("SOFTWARE"). AGREEMENTS RELATING TO ANY OTHER PRODUCT OR TOPIC ARE NEITHER INTENDED NOR SHOULD THEY BE IMPLIED. BY INSTALLING THE ACCOMPANYING SOFTWARE OR ANY PORTION THEREOF, YOU AGREE TO BE BOUND BY THE TERMS AND CONDITIONS OF THIS AGREEMENT. IF YOU DO NOT AGREE TO ALL OF THE TERMS AND CONDITIONS OF THIS AGREEMENT, DO NOT CONTINUE THE INSTALLATION PROCESS AND IMMEDIATELY DELETE ALL INSTALLED FILES, IF ANY, OF THE ACCOMPANYING SOFTWARE FROM YOUR DEVICE.

IF YOU DO NOT HAVE A VALIDLY-LICENSED COPY OF THE APPLICABLE SOFTWARE, YOU ARE NOT AUTHORIZED TO INSTALL, COPY OR OTHERWISE USE THE SOFTWARE, AND HAVE NO RIGHTS UNDER THIS AGREEMENT.

The Software is protected by U.S. and international copyright laws and conventions as well as other intellectual property laws and treaties. The Software is licensed, not sold.

GRANT OF LICENSE

Acer grants to you the following non-exclusive and non-transferable rights with respect to the Software. Under this Agreement, you may:

1. Install and use the Software only on a single designated device. A separate license is required for each device on which the Software will be used;
2. Make one copy of the Software solely for backup or archival purposes;
3. Make one hard copy of any electronic documents included in the Software, provided that you receive the documents electronically.

RESTRICTIONS

You may NOT:

1. Use or copy the Software except as provided in this Agreement;
2. Rent or lease the Software to any third party;
3. Modify, adapt, or translate the Software in whole or in part;
4. Reverse engineer, decompile, or disassemble the Software or create derivative works based upon the Software;
5. Merge the Software with any other program or modify the Software, except for your personal use; and
6. Sublicense or otherwise make the Software available to third parties, except that you may, after prior written notification to Acer, transfer the Software as a whole to a third party so long as you do not retain any copies of the Software and such third party accepts the terms of this Agreement.
7. Transfer your rights under this Agreement to any third parties.
8. Export the Software in contravention of applicable export laws and regulations, or (i) sell, export, re-export, transfer, divert, disclose technical data, or dispose of, any Software to any prohibited person, entity, or destination including, without limitation, Cuba, Iran, North Korea, Sudan and Syria; or (ii) use any Software for any use prohibited by the laws or regulations of the United States.

SUPPORT SERVICES

Acer is not obligated to provide technical or other support for the Software.

ACER LIVE UPDATE

Certain software contains elements that enable the use of the Acer Live Update service, which allows for updates for such software to be automatically downloaded and installed on your device. By installing the software, you hereby agree and consent that Acer (or its licensors) may automatically check the version of such software that you are using on your device and may provide upgrades to such software that may be automatically downloaded on to your device.

OWNERSHIP AND COPYRIGHT

Title, ownership rights and intellectual property rights in and to the Software and all copies thereof shall remain with Acer or Acer's licensors or suppliers (as applicable). You do not have or shall not gain any proprietary interest in the Software (including any modifications or copies made by or for you) or any related intellectual property rights. Title and related rights in the content accessed through the Software is the property of the applicable content owner and may be protected by applicable law. This license gives you no rights to such contents. You hereby agree

1. Not to remove any copyright or other proprietary notices from the Software;
2. To reproduce all such notices on any authorized copies you make; and
3. To use best efforts to prevent any unauthorized copying of the Software.

TRADEMARKS

This Agreement does not grant to you any rights in connection with any trademarks or service marks of Acer or of Acer's licensors or suppliers.

DISCLAIMER OF WARRANTIES

TO THE MAXIMUM EXTENT PERMITTED BY APPLICABLE LAW, ACER, ITS SUPPLIERS, AND ITS LICENSORS, PROVIDE THE SOFTWARE "AS IS" AND WITH ALL FAULTS, AND HEREBY DISCLAIM ALL OTHER WARRANTIES AND CONDITIONS, EITHER EXPRESS, IMPLIED OR STATUTORY, INCLUDING, BUT NOT LIMITED TO, ANY IMPLIED WARRANTIES, DUTIES OR CONDITIONS OF MERCHANTABILITY, OF FITNESS FOR A PARTICULAR PURPOSE, OF ACCURACY OR COMPLETENESS OF RESPONSES, OF RESULTS, OF WORKMANLIKE EFFORT, OF LACK OF VIRUSES, AND OF LACK OF NEGLIGENCE, ALL WITH REGARD TO THE SOFTWARE AND THE PROVISION OF OR FAILURE TO PROVIDE SUPPORT SERVICES. ALSO, THERE IS NO

WARRANTY OR CONDITION OF TITLE, QUIET ENJOYMENT, QUIET POSSESSION, CORRESPONDENCE TO DESCRIPTION OR NON-INFRINGEMENT WITH REGARD TO THE SOFTWARE.

EXCLUSION OF INCIDENTAL, CONSEQUENTIAL AND CERTAIN OTHER DAMAGES

TO THE MAXIMUM EXTENT PERMITTED BY APPLICABLE LAW, IN NO EVENT SHALL ACER, ACER'S SUPPLIERS, OR ACER'S LICENSORS, BE LIABLE FOR ANY SPECIAL, INCIDENTAL, INDIRECT, PUNITIVE, OR CONSEQUENTIAL DAMAGES WHATSOEVER (INCLUDING, BUT NOT LIMITED TO, DAMAGES FOR LOSS OF PROFITS OR CONFIDENTIAL OR OTHER INFORMATION, FOR BUSINESS INTERRUPTION, FOR PERSONAL INJURY, FOR LOSS OF PRIVACY, FOR FAILURE TO MEET ANY DUTY INCLUDING OF GOOD FAITH OR OF REASONABLE CARE, FOR NEGLIGENCE, AND FOR ANY OTHER PECUNIARY OR OTHER LOSS WHATSOEVER) ARISING OUT OF OR IN ANY WAY RELATED TO THE USE OF OR INABILITY TO USE THE SOFTWARE, THE PROVISION OF OR FAILURE TO PROVIDE SUPPORT SERVICES, OR OTHERWISE UNDER OR IN CONNECTION WITH ANY PROVISION OF THIS AGREEMENT, EVEN IN THE EVENT OF THE FAULT, TORT (INCLUDING NEGLIGENCE), STRICT LIABILITY, BREACH OF CONTRACT OR BREACH OF WARRANTY OF ACER OR ITS SUPPLIERS OR LICENSORS, AND EVEN IF ACER AND ITS SUPPLIERS AND LICENSORS HAVE BEEN ADVISED OF THE POSSIBILITY OF SUCH DAMAGES.

LIMITATION OF LIABILITY AND REMEDIES

NOTWITHSTANDING ANY DAMAGES THAT YOU MIGHT INCUR FOR ANY REASON WHATSOEVER (INCLUDING, WITHOUT LIMITATION, ALL DAMAGES REFERENCED ABOVE AND ALL DIRECT OR GENERAL DAMAGES), THE ENTIRE LIABILITY OF ACER, ITS SUPPLIERS, AND ITS LICENSORS, UNDER ANY PROVISION OF THIS AGREEMENT, AND YOUR EXCLUSIVE REMEDY FOR ALL OF THE FOREGOING, SHALL BE LIMITED TO THE AGGREGATE AMOUNT PAID BY YOU FOR THE SOFTWARE. THE FOREGOING LIMITATIONS, EXCLUSIONS AND DISCLAIMERS (INCLUDING DISCLAIMER OF WARRANTIES AND EXCLUSION OF INCIDENTAL, CONSEQUENTIAL AND CERTAIN OTHER DAMAGES ABOVE) SHALL APPLY TO THE MAXIMUM EXTENT PERMITTED BY APPLICABLE LAW, EVEN IF ANY REMEDY FAILS ITS ESSENTIAL PURPOSE; PROVIDED, HOWEVER, THAT BECAUSE SOME JURISDICTIONS DO NOT ALLOW THE EXCLUSION OR LIMITATION OR LIABILITY FOR CONSEQUENTIAL OR INCIDENTAL DAMAGES, THE ABOVE LIMITATION MAY NOT APPLY TO YOU.

TERMINATION

Without prejudice to any other rights, Acer may immediately terminate this Agreement without notice if you fail to comply with any terms and conditions of this Agreement.

In such event, you must:

1. Cease all use of the Software;
2. Destroy or return to Acer the original and all copies of the Software; and
3. Delete the Software from all devices on which it was resident.

All disclaimers of warranties and limitation of liability set forth in this Agreement shall survive termination of this Agreement.

GENERAL

This Agreement represents the complete agreement between you and Acer relating to this license for the Software and supersedes all prior agreements, communications, proposals and representations between the parties and prevails over any conflicting or additional terms of any quote, order, acknowledgement or similar communication. This Agreement may only be modified by a written document signed by both parties. If any provision of this Agreement is held by a court of competent jurisdiction to be contrary to law that provision will be enforced to the maximum extent permissible and the remaining provisions of this Agreement will remain in full force and effect.

ADDITIONAL PROVISIONS APPLICABLE TO THIRD PARTY SOFTWARE AND SERVICES

Software provided hereunder by Acer's licensors or suppliers ("Third Party Software") is made available to you for your personal, non-commercial use only. You may not use the Third Party Software in any manner that could damage, disable, overburden, or impair the services provided by Acer's licensors or suppliers hereunder ("Third Party Services"). Furthermore, you may not use the Third Party Software in any manner that could interfere with any other party's use and enjoyment of the Third Party Services, or the services and products of Acer's licensors' or suppliers' third party licensors. Your use of the Third Party Software and Third Party Services is also subject to additional terms and conditions and policies which can be accessed through our global website.

Privacy policy

During registration you will be asked to submit some information to Acer. Please refer to Acer's privacy policy at www.acer.com or your local Acer website.

Music recognition technology and related data are provided by Gracenote®. Gracenote®, Gracenote logo and logotype, and the "Powered by Gracenote" logo are either a registered trademark or a trademark of Gracenote, Inc. in the United States and/or other countries.

 XT9 and the XT9 logo are registered trademarks of Nuance Communications, Inc. or its subsidiaries in the United States of America and/or other countries.

Getting to know your tablet

Features and functions

Your new tablet offers leading, easy-to-access multimedia and entertainment features. You can:

- Connect to the Internet via Wi-Fi or, if your tablet includes 3G features, HSDPA+.
- Access your email while on the move.
- Keep in touch with your friends via your Contacts and social networking applications.
- Listen to rich, full-impact audio via Dolby Mobile.

Product registration

When using your product for the first time, it is recommended that you immediately register it. This will give you access to useful benefits, such as:

- Faster service from our trained representatives.
- Membership in the Acer community: receive promotions and participate in customer surveys.
- The latest news from Acer.

Hurry and register, as other advantages await you!

How to register

To register your Acer product, please visit www.acer.com. Click **Registration** and follow the simple instructions.

You can also register directly from your tablet by tapping the **Acer Registration** icon.

After we receive your product registration, you will be sent a confirmation email with important data that you should keep in a safe place.

Setting Up

Unpacking your tablet

Your new tablet comes packed in a protective box. Carefully unpack the box and remove the contents. If any of the following items is missing or damaged, contact your dealer immediately:

- Acer ICONIA TAB
- Poster / product and safety information / safety leaflet
- USB cable
- AC adapter
- Warranty card / ITW
- GPL notice

Getting to know your tablet

Front view

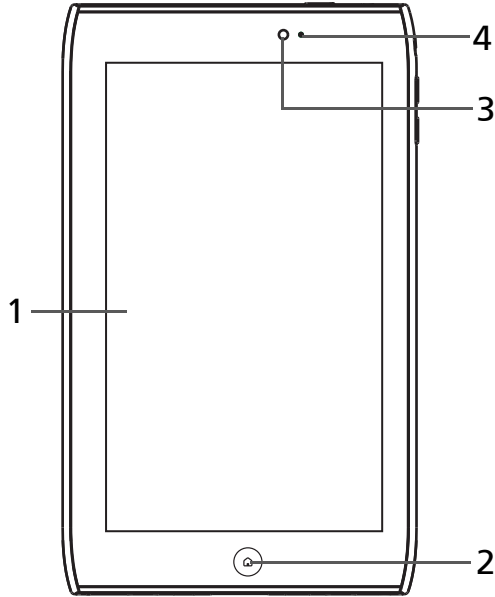

No.	Item	Description
1	Touchscreen	7-inch, 1024 x 600 pixel capacitive touchscreen.
2	Home button	Tap this icon to go directly to the Home screen.
3	Front-facing camera	A 2-megapixel camera for video chatting and self-portrait images.
4	Light sensor	Detects ambient light and automatically adjusts the screen brightness.

Back view

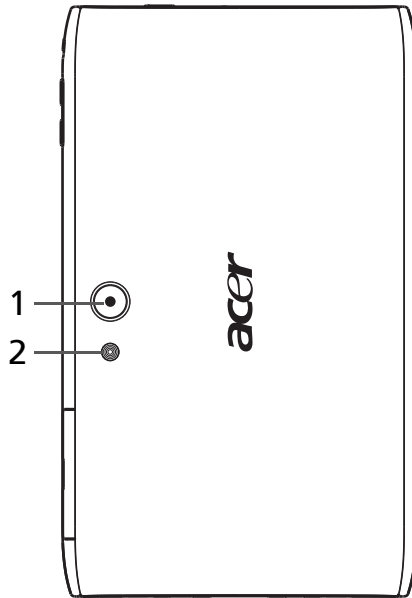

No.	Item	Description
1	5 MP camera	A 5-megapixel camera for taking high-resolution images.
2	LED flash	Lights to illuminate images.

Top view

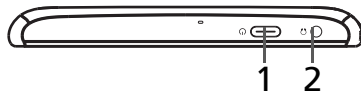

No.	Item	Description
1	Power button	Long press to turn the tablet on, press briefly to turn the screen on/off or enter sleep mode; press and hold to turn the tablet off.
2	3.5 mm headphone jack	Connects to stereo headphones.

Bottom view

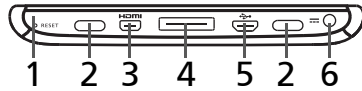

No.	Item	Description
1	Reset button	Insert a small thin object (such as a paperclip) to reset power to the tablet.
2	Speakers	Emits stereo audio.
3	Micro HDMI (Type D) connector	Connects to an HDMI cable with a Type D connector.
4	Docking port	Connect your tablet to the dock accessory.
5	Micro USB connector (Slave)	Connects to a computer with a USB cable.
6	DC-in jack	Connects to the DC power supply.

Side view

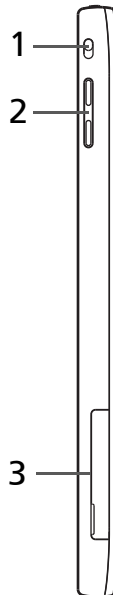

No.	Item	Description
1	Screen rotation lock switch	Use this switch to lock the screen rotation or allow the screen to match the tablet's orientation.
2	Volume control key	Increase and decrease the tablet volume.

No.	Item	Description
3	Card slot cover	<p>Insert a micro SD card into the slot under this cover.</p> <p>See “Inserting a microSD card (optional)” on page 24.</p> <p><i>An optional SIM card slot allows you to access the Internet if you have a cellular data subscription.</i></p>

Using your tablet

Using the SIM card slot (only for Wi-Fi+3G models)

Certain tablets include a SIM slot for internet access. To take full advantage of your tablet's Internet capabilities, you should install a SIM card with data subscription *before* turning on your tablet.

See "Installing a SIM card" on page 50.

Charging your tablet

For first-time use, you need to charge your tablet for four hours. After that you can recharge the battery as needed.

Connect the DC-in jack to your tablet and plug the AC adapter into any AC outlet.

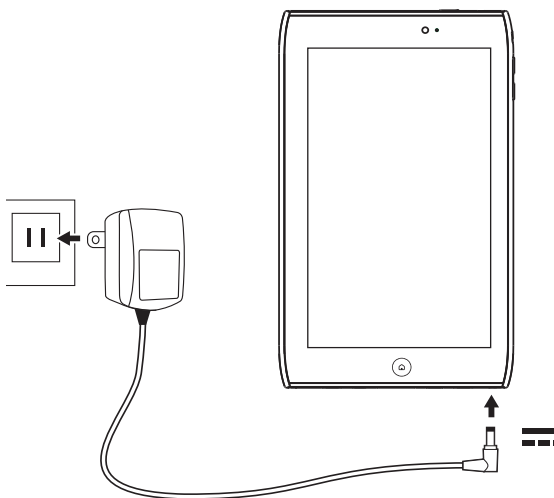

Note: It is normal for the tablet surface to become warm during charging or long periods of use.

Turning on for the first time

To turn on your tablet, press and hold the power button for two seconds. You will then be asked some questions before you can use your tablet.

To start, tap to select your language, then tap **Start**. Follow the rest of the instructions as they are displayed.

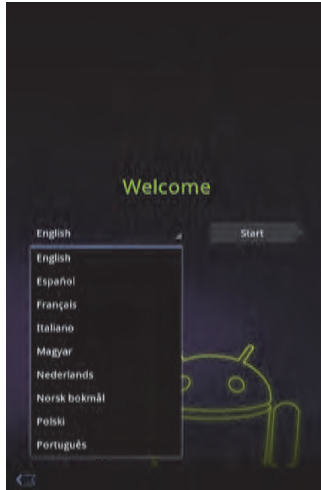

Sign in to or create a Google account

If you have Internet access, your tablet allows you to synchronize information with a Google account.

During the start-up process, you may create or sign in to an account, which will be used to synchronize your contact list, email, calendar and other information. If you do not yet have Internet access, or do not want to use this feature, then tap **Skip**.



Important: You must sign in to a Google Account to use Gmail, Google Talk, Google Calendar, and other Google Apps; to download applications from Android Market; to back up your settings to Google servers; and to take advantage of other Google services on your tablet.

If you want to restore existing settings from another device with Android 2.0 (or later) installed, you must sign in to your Google account during setup. If you wait until after setup is complete, your settings will not be restored.



Note: If you have multiple Google accounts, such as separate accounts for personal and business contacts, you can access and synchronize them from the Accounts settings section. See **"Multiple Google accounts"** on page 57.

Locking your tablet

If you will not use your tablet for a while, briefly press the power button to lock access. This saves power and ensures your tablet does not unintentionally use any services. Your tablet will lock automatically if it is not used after a while. To change the delay, tap **Apps > Settings > Screen > Timeout**.

Waking your tablet

If the screen is off and the tablet does not react to any taps on the screen, then it has been locked and is in sleep mode.

To wake your tablet, press the power button. Your tablet will display the Lock screen. Drag the lock symbol to the edge of the circle to unlock the tablet.



For additional security, you may set a code or number that must be entered to access the tablet, such as an unlock pattern (a set of dots that must be tapped in the correct order). Open the Home screen and tap **Apps > Settings > Location & security > Configure lock screen**.



.....
Note: If you forget an unlock pattern or PIN, please refer to “**Unlock pattern**” on page 61.
.....

Using the touchscreen

Your tablet uses a touchscreen for selecting items and entering information. Use your finger to tap the screen.

Tap: Touch the screen once to open items and select options.

Drag: Hold your finger on the screen and drag across the screen to select text and images.

Tap and hold: Tap and hold an item to see a list of actions available for that item. On the pop-up menu that appears, tap the action you want to perform.

Scroll: To scroll up or down the screen, simply drag your finger up or down the screen in the direction that you want to scroll.

The Home screen

When you start your tablet, or wake it from power saving, it will display the Home screen. This screen gives you quick access to information and simple controls with widgets or shortcuts. These display information such as the time and favorite bookmarks, or provide additional controls and direct access to applications. Some have been pre-installed on your tablet, while others may be downloaded from the Android Market.

The Home screen already features some useful controls and information.

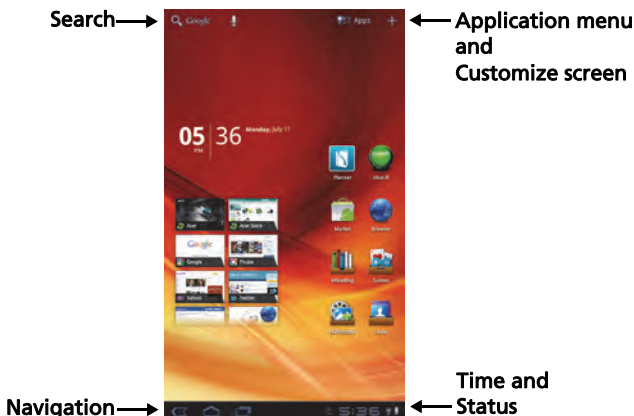

Search

To search for applications, files or for information on the Internet, tap the **Google / Search** icon in the top-left corner.



Simply enter the text you want to find. Tap the arrow or Enter key to search the Internet, or tap one of the suggestions, applications or files shown in the list.



Note: In order to search or browse the Internet, you must be connected to a cellular data (if available) or wireless network. See **“Going online” on page 27.**

Voice search

If voice search is available, tap the microphone and speak your search request. See **“Voice Search” on page 28.**



Navigation

To navigate through menus and options, three (or more) icons are shown in the bottom-left corner.



Back

Tap this icon to go to the previous page, or to go up one level in a menu. This icon may be replaced with the *hide* icon in certain cases (such as if the keyboard or list of recent applications is shown).



Home

Tap this icon to go directly to the Home screen.

Recent

Tap this icon to see recently opened applications. Tap an application to open it, or tap anywhere on the screen to return to the Home screen.

Settings

This icon is displayed in some applications. Tap this icon to open a list of options.



The extended Home screen

The Home screen extends to either side of the initial Home screen, giving you more room to add widgets or organize shortcuts. To view the extended Home screen, swipe your finger to the left or right.

A total of five pages are available, two to the left and two to the right. To change or add widgets on any of the screens see **"Personalizing the Home screen"** on page 19.



The application menu

The application menu displays applications installed on your tablet.

Two categories are available: **All** and **My apps**. **All** displays all applications that are installed on your tablet; **My apps** displays applications that you have installed from the Android Market.



Note: All images are for reference only. The applications installed on your tablet can be different from the applications shown in illustrations.

Applications are displayed in alphabetical order. If more applications are available, an outline of the second page will be shown on the side of the screen. Swipe the outline towards the center of the screen to switch pages.

Tap and hold an icon to add a shortcut to one of your Home screens. While a shortcut is selected, thumbnails of the Home screens are shown below the list of applications, simply drag the shortcut to a screen.

Status and notification area

Status and notification icons are shown in the bottom-right corner of the screen.

This area contains a variety of icons to inform you of your tablet's status. The icons on the right side of the clock indicate connectivity and battery status. The left side of the clock displays the event notification icons.



Time

Wireless
reception

Battery
charge
status

Tap the status icons to view more status information and a summary of events.



Tap the status area again to view more controls. While viewing a notification, tap the summary to see more information, if available. Some event summaries include controls, such as media controls if music is playing.



Status and notification icons





















Connection and battery status icons



















Note: Network connection icons are blue if you have an active Google account.

Icon	Description	Icon	Description
	Connected to a wireless network (waves indicate connection strength)		Battery is very low
	An open wireless network is available		Battery is low
	Bluetooth is on		Battery is partially drained
	Connected to a Bluetooth device		Battery is full
	Airplane mode (wireless connectivity disconnected)		Battery is charging

Notification icons

Icon	Description	Icon	Description
	Alarm is set		Speaker is silenced
	New Gmail message		Tablet microphone is off
	New Google Talk message		GPS is on
	Upcoming event		Receiving location data from GPS
	Song is playing		More status notifications
	SD card or USB storage is full		Syncing data
	Tablet is connected to PC via USB		Sync is on
	Application update available		Problem with sign-in or sync
	System update available		Uploading data
	Virtual private network (VPN) status		Downloading data (animated)
			Download finished

Cellular data status icons (only for Wi-Fi+3G models)

Icon	Description	Icon	Description
	Cellular signal strength		Roaming
	Connected to GPRS network		No signal
	GPRS in use		SIM card is invalid or not installed
	Connected to EDGE network		New/unread SMS/MMS
	EDGE in use		Problem with sending SMS/MMS
	Connected to 3G network		USB tethering is activated
	3G in use		Bluetooth tethering is activated
	Carrier data use threshold exceeded		Wireless tethering is activated
			Multiple tethering or hotspot connections are activated

Personalizing the Home screen

You may personalize your Home screen by adding or removing application shortcuts or widgets, and by changing the wallpaper.

Adding or removing shortcuts or widgets

To add shortcuts or widgets open the **Add to Home** screen: tap **(+)** next to **Apps** in the top-right corner of the Home screen. Alternatively, tap and hold anywhere on the Home screen.



Tap **Widgets** to see small applications that you can add to a Home screen. Widgets are small applications that display constantly-updated information or quick shortcuts to applications or special functions.

Tap **Applications** to open a list of shortcuts to applications and settings you can drag to a Home screen.

Tap **Wallpapers** to change the current wallpaper. You can choose from a set of pre-formatted wallpapers, images stored in the Gallery, or Live wallpapers featuring animated or interactive backgrounds.

Tap **More** to add icons, shortcuts, 'groups' of contacts or links to specific settings.

To move any item on the Home screen, tap and hold the item until it is selected. You may drag the item to any free area on the screen. To move the item to a different Home screen, drag it to the side of the screen, the Home screen will switch to the screen in that direction. Release the item when it is positioned correctly.

To remove an item from the Home screen, tap and hold the item until the trash icon appears in the top-right corner of the screen. Simply drag the item to the trash icon.

Adding shortcuts from the Application menu

You can add shortcuts to the Home screen directly from the Application menu. Open the Application menu then tap and hold an icon until an image of the Home screens appears. Drag the icon to a Home screen to create a shortcut.

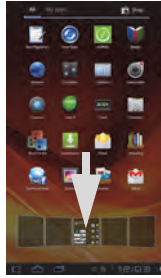

The onscreen keyboard

When you tap a text box to enter text, an onscreen keyboard will appear. Simply tap on keys to enter text.

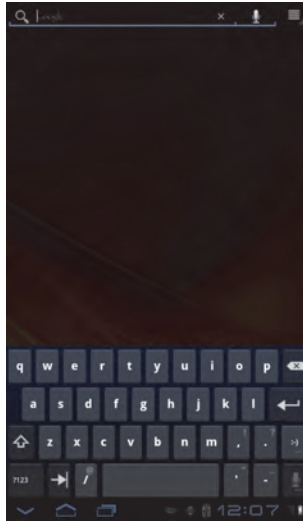

Tap the **123** button to see numbers and special characters, and then tap the **More** key to see more options. Tap and hold a key to select alternative characters (if available), such as letters with accents.

The layout of the keyboard varies slightly, depending on the application and information that is required.

Changing Android keyboard settings

To use a different keyboard language or change settings, tap the **Input options** key, then select either **Input languages** or **Android keyboard**



settings. These settings include Auto-correction and keyboard sounds and vibration.

Predictive text or auto correction

The Android keyboard can provide predictive text input. As you tap the letters of a word, a selection of words are displayed that continue the sequence of letters tapped, or are a close match allowing for errors. The word list changes after every key press. If the word you need is displayed, you can tap on it to insert it into your text.

To turn predictive text on or off with the Android keyboard, tap the **Input options** key, and then **Android keyboard settings**. Tap **Auto correction** or **Show correction suggestions** and select one of the options.

Changing the keyboard

To use a different keyboard type, tap the **Keyboard status** icon; this will open a menu listing the text input methods available on your tablet. Tap your preferred input method.



Typically three options are available: two types of **Android Keyboard** (keyboard and voice) and **XT9 Text Input**.

XT9 Text Input

The XT9 keyboard provides an alternative to the standard Android keyboard.

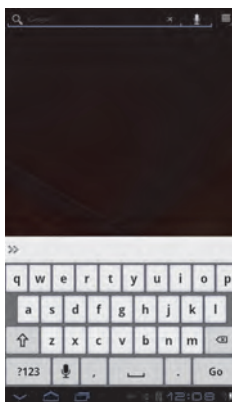

Tap the **?123** button to see numbers and special characters, and then tap the **ALT** key to see more options. Tap and hold a key to select alternative characters (if available), such as letters with accents.

Additional keys vary depending on the type of text you enter, e.g. a key to add a smiley is available when typing a text message. Like other keys, tap and hold to see if additional options are available.

Text assistance

The standard XT9 keyboard has various features that assist you to enter correct text. To use these features, tap the **Keyboard status** icon; this will open a menu

listing the text input methods available on your tablet. Tap the settings icon next to the **XT9 Text Input** entry.

Function	Description
Languages and settings	Set the languages that will be available. If you have selected more than one language, tap the globe in the text prediction bar to cycle through the languages. Tap and hold the globe to see a list of selected languages.
Preferences	Change your text input preferences.



Editing text

You can select and edit text in certain applications, such as text you have entered in text fields. Selected text can be cut or copied and later pasted within the same application, or to a different application.



Note: Certain applications may not support text selection, or only support it in certain areas. Other applications offer specialized commands to select text that is only available in that application.

Selecting text

To select text that you want to cut, copy, delete or replace:

1. Tap the text you want to select. If you can select this text, a cursor is inserted below the text.



Note: The cursor indicates where text you type or paste will be inserted.

2. Tap and hold the text or word you want to select.
The selected text is highlighted, with a tab at each end of the selection.

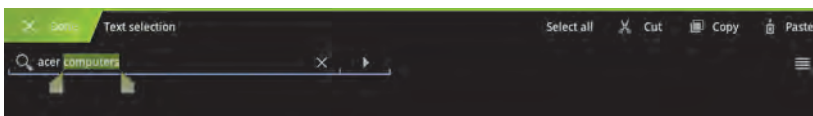

3. Drag either tab to expand or reduce the amount of selected text, or tap **Select all**.
4. To cut or copy the text, tap the **Cut** or **Copy** button.

Inserting text

To type new text or add text that you have copied:

1. Tap the text you want to select. If you can select this text, a cursor is inserted below the text.



Note: The cursor indicates where text you type or paste will be inserted.

2. If the cursor is not in the desired position, simply drag it to the correct position.
If you previously copied (see below) text, a *Paste* button appears briefly above the cursor. Tap the button to paste the text.

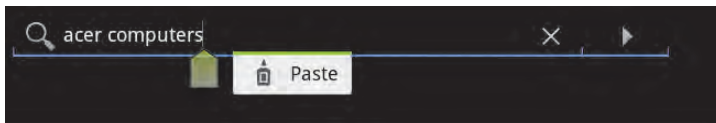

3. Modify the text: Type, paste or delete text.
4. Tap Enter on the keyboard, or tap the **Close Keyboard** button.

Connecting devices to your tablet

Connecting to AC power

See "Charging your tablet" on page 11.

Inserting a microSD card (optional)

You may install a microSD card to expand your device's storage space.



.....
Note: Your tablet only supports microSD cards that use the FAT or FAT32 file system.
.....

1. Open the card slot cover.
2. Insert the microSD card as shown. Ensure that the microSD card is inserted all the way into the card slot.
3. Replace the card slot cover.

Check card capacity in the **External SD card** section of **Apps > Settings > Storage**.

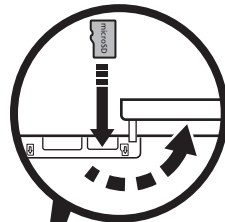

Transferring files between a microSD card and your PC

Remove the card from the tablet and use a card reader or USB adapter to access the card as an external storage device.



.....
Note: Check that your tablet is not using the microSD card before removing it from the tablet. Take care when removing the card, the slot is spring-loaded.
.....

Connecting to a PC as a USB storage device

Download and install the latest USB driver on your computer before connecting your tablet to the computer. Visit www.acer.com for the latest drivers: Select **Support, Download, Tablet**. Select your tablet model, and then the **Driver** tab, select **USB** and accept the download.

This allows you to transfer your personal data to or from your PC, using your PC's file explorer.

Plug the micro USB connector to your tablet, and plug the other end of the USB cable into a USB port on your PC.

After a short delay, your tablet's internal memory will be visible as an external drive in your PC's file explorer.

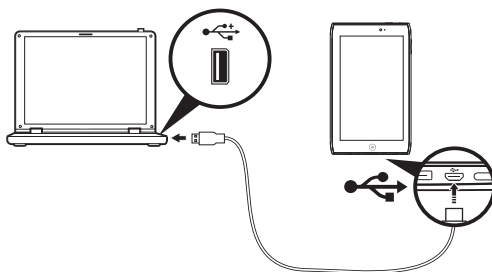

Connecting a Bluetooth device

Only A2DP stereo headsets (without microphone) are supported. Please check for updates to the tablet's software which may add support for additional Bluetooth devices.

For Bluetooth settings, tap **Apps > Settings > Wireless & networks > Bluetooth settings**.

Tap **Find nearby devices** to scan for available devices.



.....
Note: Please check for updates to the tablet's software that may add support for additional Bluetooth devices. See **"Updating your tablet's operating system"** on page 58.
.....

Connecting to a television with HDMI

Connect an *micro HDMI* (Type D) cable to your tablet then plug the other end of the cable into a TV or monitor with an HDMI port.

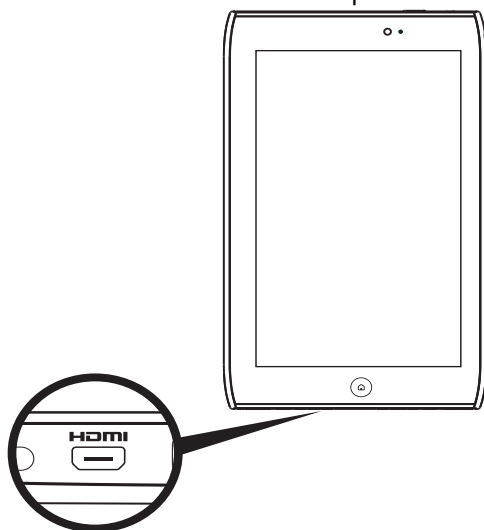



Note: When using the micro HDMI port to connect the tablet to an external device, the tablet's screen will switch orientation to landscape to mimic the aspect ratio of the external device.

Connecting to the dock (optional)

The optional dock holds your tablet and allows you to easily charge the battery with a single connection.

The dock provides extra ports that replace your tablet's built-in ports while it is docked. Please check the dock's specifications for the exact features provided.

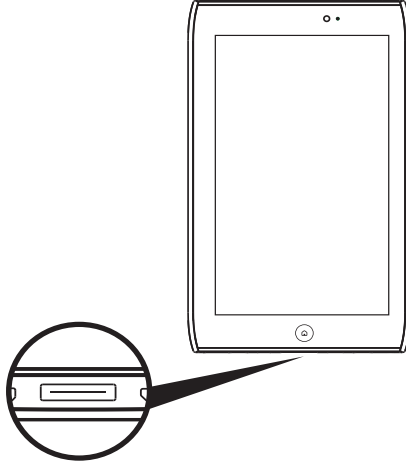

Warning! The screen will remain locked in landscape mode when the tablet is connected to the dock.

Going online

Managing Wi-Fi connections

If you did not connect to a Wi-Fi network when you first started your tablet, or want to connect to a new network, tap **Apps > Settings > Wireless & networks > Wi-Fi settings** to manage your connection settings. Alternatively, tap the Wi-Fi status icon in the bottom-right corner of the screen.

If Wi-Fi is not on, tap **Turn on Wi-Fi**, and wait for your tablet to detect nearby networks. Tap the name of your network and enter a security password, if needed.

Browsing the Internet

In order to browse the Internet with your tablet, you must be connected to a network with a connection to the Internet.

Using the browser

To start browsing, tap a bookmark from the bookmark widget on the Home screen, or open the Application menu and select **Browser**. To enter a website address, tap the address box at the top of the page. Enter the address using the keyboard and tap **Enter** or the Go arrow.

To view your browsing history, bookmarks or frequently visited sites, open the browser then tap the bookmark icon in the top-right corner.



You may open multiple tabs. When a page is open, press the small tab with a (+). Simply tap one of the tabs across the top of the screen to switch pages.

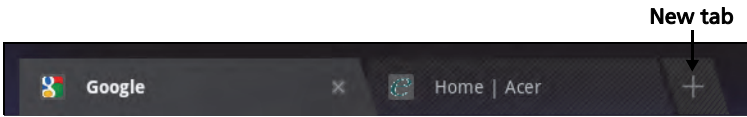

Pinch to zoom in or out of pages. Tap and hold an item on a page to open a contextual menu.

Voice Search

With voice actions, you can send emails, find directions to locations, search the Internet and even send a note to yourself using your voice. Tap the microphone on the Home screen or open **Voice Search** from the applications tab. When the **Speak now** prompt is displayed, state your command or query.

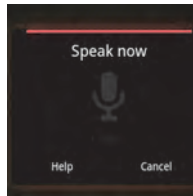

.....
Note: Voice Search is available only in selected regions.
.....

Setting up Gmail (Google mail)

1. Make sure your tablet is connected to the Internet.
2. From the Applications menu tap **Gmail**.

If you did not enter a Gmail account address and password when you first started your tablet, follow the instructions.



.....
Note: You need to activate a Google account before you can use Gmail.
.....

Composing an email

1. Make sure your tablet is connected to the Internet.
2. Open the application menu and tap **Gmail**.
3. Press the **Menu** button and then tap **Compose**.
4. Enter the recipient's email address, the subject and message.
5. When you are finished composing your message, tap **Send**.

Setting up the Email application

The Email application enables you to access email from most popular email providers. Most accounts can be set up in two steps. Open the application menu and then tap **Email** to start setting up your email access.

If necessary, enter your email address and tap **Manual setup** to enter the parameters manually. Tap **Next** to finish the setup process.

The combined inbox feature of your tablet allows you to view emails from multiple accounts in a single inbox.

Online applications

Your tablet provides a variety of preinstalled applications. Many of these require some form of Internet access.

These applications may include:

- **Acer Sync:** Sync your data between your tablet, your computer and the Google servers.
- **Acer Planner:** View your emails, agenda items, and memos in one location.
- **SocialJogger:** View updates to your social networks in one location.
- **Maps:** Get easy-to-follow directions using Google Maps.
- **Talk*:** Chat with your friends, with text, sound and video.
- **Navigation*:** Turn-by-turn navigation with live traffic, multiple visible layers and text-to-speech take you where you want to go.
- **Latitude:** View where your friends are on Google Maps.
- **Places:** View places of interest and local businesses on Google Maps.
- **YouTube*:** View the most viewed and most discussed video clips on YouTube.
- **Books:** Download books from featured bookstores.
- **MusicA:** Let your tablet listen to music and access the MusicA database to find the track name and artist.



.....
* **Note:** Applications installed may vary according to your region.
.....

Acer Sync

Acer Sync lets you synchronize your contacts, calendar, photos and video clips between your tablet, computer and corresponding Google services.

Setting up Acer Sync on your computer

Acer Sync must be installed on your computer before it can be used. Follow the steps below to install Acer Sync on your computer.

1. On your computer visit <http://support.acer.com> and select your device.
2. From the device support page, download and run the Acer Sync application on your computer.

3. Follow the instructions on your computer screen to configure Acer Sync and start the synchronization.

Configuring Acer Sync on your tablet

1. Tap **Apps > Acer Sync**.
2. Tap the settings icon in the top-right corner.
3. Select **Settings** from the menu.



Acer Planner

Acer Planner helps you to manage events and work efficiently.

Tap **Planner**.



Acer Planner will automatically link to your email account that can be setup via the Email application. See **“Setting up the Email application”** on page 29.

Within the Acer Planner you will see four tabs: **Today**, **Agenda**, **Note**, and **Priority**.

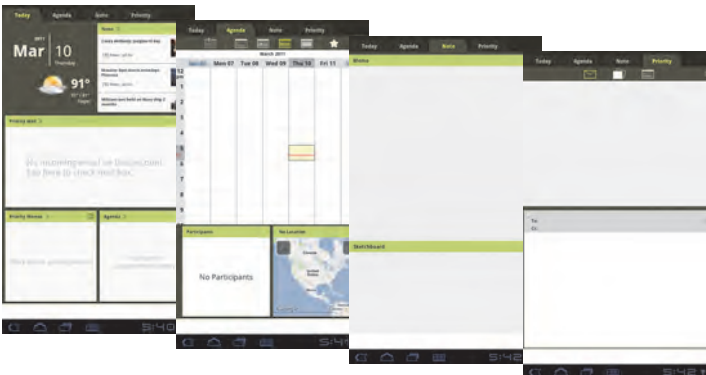
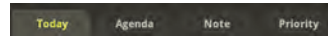

Planner Today

Tap the **Today** tab to see an overview of your priority mail, priority memos, local weather, your agenda for the current day, and the current day's news.

Tap on an item to view its details. You can also tap the (+) to the right of Priority Memos or Agenda to add an item.

Planner Agenda

Tap the **Agenda** tab to access your agenda.

At the top of the Agenda screen you can click on the different icons to change the view from hourly, daily, weekly, or monthly.

The bottom frame in the Agenda screen can be flicked left or right to show the participants, the location, memos, sketches, and related email associated with the agenda item.

To add a new agenda item, tap the (+) on the top-right corner.

Planner Note

Tap the **Note** tab to access your memos and sketches.

Tap on a memo or sketch to enlarge or edit it. To add a new memo or sketch tap the (+) next to the appropriate item.

Planner Priority

Tap on the **Priority** tab to access a prioritized view of your emails, memos, and agenda items.

SocialJogger

SocialJogger combines your social network updates in one location, allowing you to quickly follow what your friends are doing across several platforms.

From the application menu, tap SocialJogger to launch the program.

Select **Sign in** to enter your account information. When you are finished press **Start**.

Slide the disc, located on the right, up and down to cycle through the status updates.

Tap on a status to view more details and make a comment.

Tap the left and right arrows, located on the top, to cycle between the categories: My Page, Photos, Links and any added pages.

Tap the **Menu** button to access account settings, refresh the page, auto play, and add or remove custom pages.

Adobe Flash Player

Adobe Flash Player is not installed on your tablet. If you want to use Flash content on in your browser, you can visit the Android Market (see below) to easily download and install Adobe Flash Player.

Android Market



Note: The Android Market may not be available in all countries and regions.



Note: You must activate a Google account before using the Android Market.

Tap **Market** from the home screen or application menu to open the Android Market. Here you can obtain a variety of add-on programs and applications to enhance the functionality of your tablet.

You may also browse for books that you may read with Books or another reader application.

The first time you access the Android Market, you must read and accept the Terms of Service.

You can browse the market by category or tap the search icon to search for a specific application.

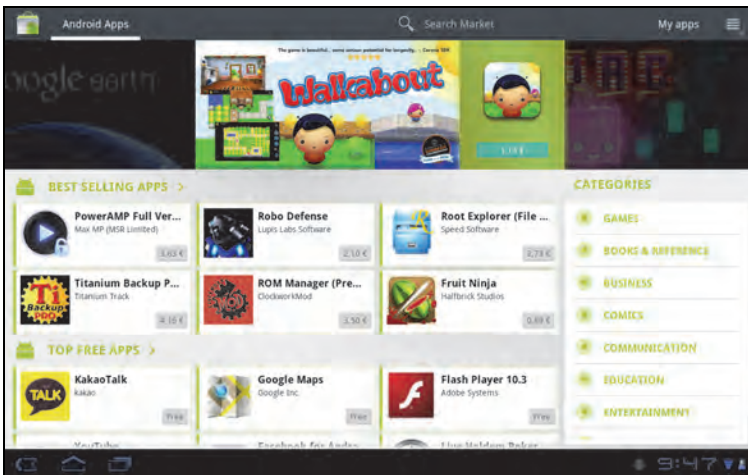

Once you have selected an application, tap the **DOWNLOAD** button to download and install the application. You will be told which services (contact information, wireless access, GPS, etc.) the application requires access in order to function correctly. If none of these services seem unusual, tap **OK** to proceed with the installation.

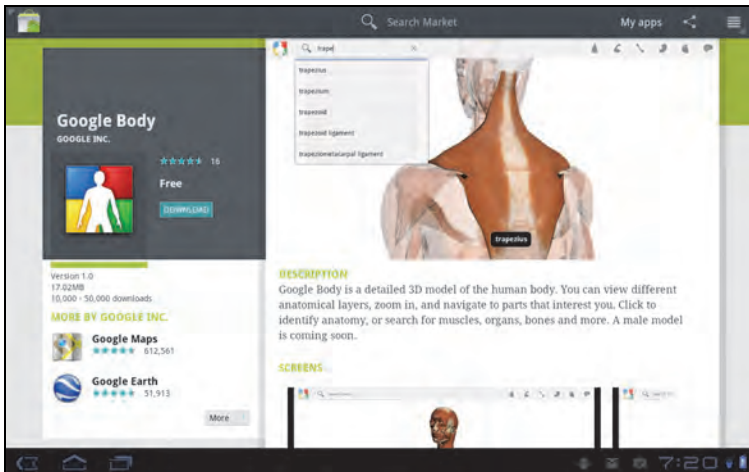

You may keep track of the download progress from the status area.



.....
Important: Some applications may require payment before you can download them. You will need to have a Google Checkout account in order to pay for these applications.
.....

Using downloaded applications

Once you've downloaded and installed an application, you may find it in the **My apps** or **All** sections of the Application menu.

Certain applications also provide widgets, or only provide a widget (with no application icon). Widgets can be found in the Widget section when personalizing your Home screen. See "Personalizing the Home screen" on page 19.

Uninstalling downloaded applications

Once you've downloaded and installed an application, you may uninstall the application by pressing and holding the application icon and dragging it to the trash can located on the top-right corner of the screen.

Alternatively, you can go to **Settings** from the application menu and select **Applications > Manage applications**. Tap the application you wish to uninstall, tap **Uninstall** and confirm the uninstall.

Google Talk



.....
Note: Google Talk may not be available in all countries and regions.
.....



.....
Note: You need to activate a Google account before you can use Google Talk.
.....

Tap **Talk** from application menu to open Google Talk. Here you can see a list of your contacts connected to Google Talk services. Tap on a contact to open a chat session. After you have connected, you can open a video chat session.



Use the front-facing camera so the person you call can see you while you can see them on the screen; hold your tablet in portrait mode to improve the camera position.

Books

The Books application allows you to purchase, store and read books on your tablet. Tap the **Books** shortcut in the Application menu, or the eReading content folder, to open the Books application.

Viewing your books

All books stored on your tablet may be seen on the Books application main screen. If you have many books, swipe the screen left to see them.

Simply tap a book to open it. Rotate your tablet to the best angle to read the book.

Adding books

You may either add books that you already own, or download new books directly to your tablet.

To download books, click on the Shop icon in the top right of the screen. A new web browser window will open to the Google ebookstore.

To add books you already own, see **“Transferring files between a microSD card and your PC”** on page 24 or **“Connecting to a PC as a USB storage device”** on page 24.

Reading a book

Simply swipe across a page to change the page. More options, such as searching the book, or jumping to a different chapter are available by clicking on the appropriate icon in the top-right of the screen.

Acer content folders

Your tablet includes content folders that allow you to easily organize and access your favorite applications.

Choose one of the four categories on the Home screen or application menu: **eReading**, **Games**, **Multimedia** or **Social**.



Tap the shortcut to open a screen containing applications from that category.

Using the content folders

Each category already contains shortcuts to essential applications. Simply tap a shortcut to open the application. The shelves along the bottom of the screen may contain links to portals that allow you to download related applications from trustworthy publishers.



Selecting a content folder

The folder shortcuts on the home screen or Application menu give you direct access to any of the four categories. If you have opened a category, you can easily change category by swiping the screen to the left or right.

Adding

You can add applications to any content folder. Tap **(+)** in the top right corner and select one or more applications from the list. Tap **OK** to add shortcuts for the selected applications.

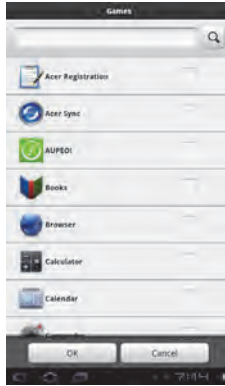

You may view up to twenty shortcuts on a single screen. If you add more than twenty shortcuts, swipe the screen up to see additional shortcuts.

Moving or removing

Tap and hold an item to select it. Drag it to a new position to change the order, or to the trash can in the top right corner to remove the shortcut from the screen.

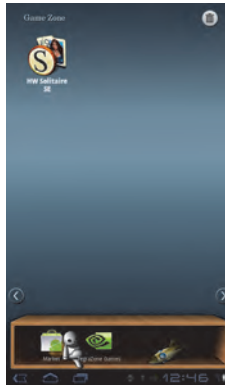

Note: Certain preloaded applications may not be removed.

Playing music and video

Multimedia playback

Your tablet comes supplied with a variety of programs that you can use to enjoy multimedia content.

Music

Use **Music** to listen to music and other audio files that you download or copy from your computer.



Tap **Apps > Music** to open the application.



Tap the **Shuffle All** cover to play a random selection, or swipe through the albums and tap to view a list of tracks. Tap the play symbol or a track to start playback. Tap the Music icon to return to the previous view.

To change how your music is displayed, tap the arrow next to **New and recent**.

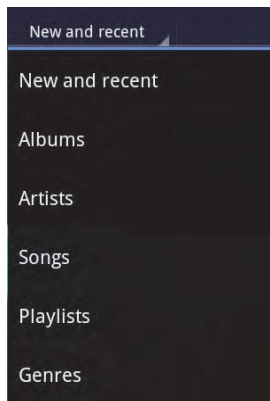

Depending on your selection, your music library is displayed as a grid of album covers or a list of tracks.



Note: You can return to the Home page while playing music; a Music icon is displayed with the notification icons. Tap this icon to control playback.



Acer clear.fi

clear.fi automatically connects all of the devices on your home network (your smartphone, notebook, all-in-one PC, HD media player, home storage, etc.) and gathers media files from those devices, then categorizes them as Videos, Photos, or Music. This lets you easily manage, store, share and enjoy your media from any device, in any room, at home. In addition, you can connect to your Facebook, Flickr and YouTube accounts via clear.fi to check out photos and videos, as well as publish your own media to those sites.



Note: To use clear.fi, your devices need be on the same network (wired or wireless) with clear.fi-installed software.



Note: When using an external USB storage device to access media files, the device may not be recognized for a few minutes.

Tap **clear.fi**.



Acer clear.fi will automatically detect devices that are connected to the network and are also running Acer clear.fi. These devices are displayed at the bottom of the screen, with your tablet as the default device on the leftmost side. Tap any of the connected devices and then tap **Photo**, **Video**, or **Music** to browse media files on that connected device.

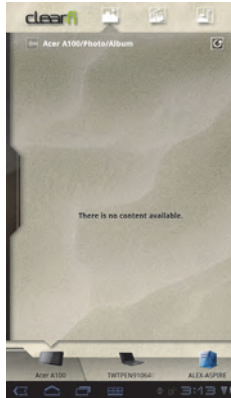

Drag the bar to the left for more viewing options.

clear.fi photos

Tap the photo album to view the thumbnails. Tap and hold an album or photo thumbnail to view the menu panel.

You can view photos found on any of the connected devices and save them.

Tap and hold a photo thumbnail, then tap and hold any of the connected devices showing an arrow. Select **Play** or **Save**.

To upload a photo to Facebook, or Flickr via Acer Photo Uploader, or to paired devices using Bluetooth, tap and hold a photo thumbnail, then tap **Share**.

clear.fi videos

Tap a folder under Collection to view the thumbnails. Tap and hold a folder or video thumbnail to view the menu panel.



You can play videos found on any of the connected devices and save them. Tap and hold a video thumbnail, then tap and hold any of the connected devices showing an arrow. Select **Play** or **Save**.



.....
Note: The Acer clear.fi video player only plays MP4 files. Please check for updates to the tablet's software which may add support for other types of video. See **"Updating your tablet's operating system"** on page 58.
.....

To send video files, for example, to paired devices using Bluetooth or to YouTube, tap and hold a photo thumbnail, then tap **Share**.

clear.fi music

Tap a folder to list the audio files. Tap and hold a folder or audio file to view the menu panel.

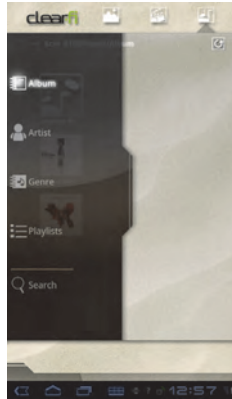

You can listen to any audio file found on any of the connected devices and save them. Tap and hold an audio thumbnail, then tap and hold any of the connected devices showing an arrow. Select **Play** or **Save**.

To send audio files as an email attachment using Google Mail, or to paired devices using Bluetooth, tap and hold a photo thumbnail, then tap **Share**.

Sharing media content with clear.fi

To choose which media content will be shared from your tablet you will need to modify the Media Server settings, See **"Media Server"** on page 42.



.....
Note: Acer clear.fi follows the DLNA 1.5 standard to communicate with other media devices, so it can work with devices that are also DLNA 1.5 certified, regardless of brand.
.....

nemoPlayer

Open nemoPlayer from the Application menu to play media you have stored on your tablet.



nemoPlayer enables you to listen to music, view video clips and pictures in all the formats supported by your tablet. See **"Multimedia"** on page 62.

Media Server

Your tablet can act as a digital media server using UPnP technology. This means that you can use it to send media content to other UPnP-enabled home entertainment devices that are connected to a home wireless network.

To set up the media server, open the application menu and tap **Media Server**.

You will need to enable **Share contents** before you can start using the service.

You may select to share **Video**, **Photo** or **Music**. Tap a category to control which files are shared.

Dolby Mobile

To access Dolby Mobile settings go to the application menu and tap **Settings > Dolby Mobile**. Here you can switch Dolby Mobile on or off, set Treble, Natural Bass, Music EQ and Video EQ.

Managing contacts

Your tablet features an address book that allows you to save contacts to the internal memory, SIM card or your Google account.

Tap **Contacts** from the application menu to view your contacts.

If you don't have any contacts stored on your tablet, you can sync with your Google account contacts, import contacts from a contact data file (vCard or csv) or add a new contact.



If you have activated a Google account that includes contacts, your contacts will be synchronized automatically. See **"Synchronization"** on page 56.

Importing contacts

Tap the Menu button and select Import/Export. Tap the option that describes where your contacts are stored. When the contacts are found, confirm to import the contacts in a new group.



Adding a new contact

Tap **New** to add a new contact. You will be asked which account you want to use to store the contact. If you select the name of your tablet it will be stored in the tablet's internal memory, and not synchronized with other accounts.

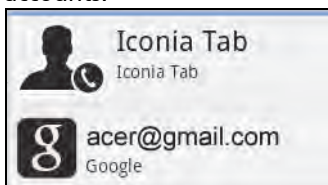

You may now edit the new contact entry.

Editing a contact

If you have opened an new or existing contact you can enter information about the contact:

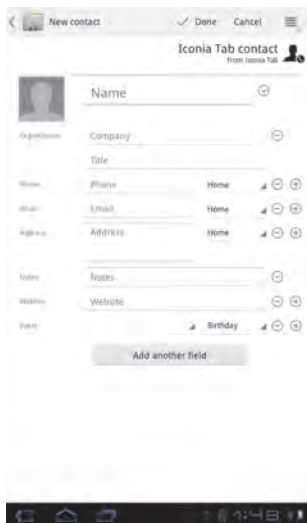

Simply tap on a box and type the appropriate information. Click on the arrow next to the name entry to see options, such as adding a name prefix or phonetic name.

To enter multiple entries, such as separate entries for mobile and home phone numbers, tap **(+)** to create a second entry. Tap the minus sign to remove an entry.

Tap **Add another field** for more categories.

To assign an image to your contact, tap the silhouette and select an image from your tablet's picture gallery (select **Gallery** if requested). You may also take and crop a new photo.

Tap **Done** to finish and save the contact.



Tip: Set each phone number to match the type of network as this can determine some functions, i.e. certain applications only recognise 'Mobile' numbers as they require a function only available on a mobile network.

Opening a contact

To see the information stored for a contact, tap on the contact's name in the list on the left.

Tap on an entry (such as an email address) to open the application linked to that type of entry. For example, tap an email address to open the **Gmail** application.

To add or change information, tap the pencil icon.

Tap **Done** to save changes, or **Cancel** to discard them.



Starred contacts

You may quickly access your favorite contacts by adding a *star*. First open the contact, then tap the star next to the contact's name. Tap **All contacts** and select **Starred** to see only your favorite contacts.

Editing a contact on your computer

If you have synchronized your Google account and contacts, you can use your computer to access and edit your contact list. Open the Internet browser on your computer and go to **contacts.google.com**. Sign in to your account then select and edit contacts from the list; the next time your tablet synchronizes with your computer, these changes will also be made to your tablet's contact list.



.....
Warning! Back up your contacts before making any changes. Tap the Menu button and select Import/Export. You may then Export your contact list to your tablet's internal memory, or other options depending on installed applications.
.....



Using the camera

Your tablet features two cameras: a 5-megapixel digital camera and flash mounted on the rear and a 2-megapixel digital camera mounted on the front. This section will take you through all the steps in taking photos and videos with your tablet.

.....
Note: Photos and videos can only be saved to internal memory or a microSD card, not an external USB device. It is recommended that you insert a microSD card into the microSD slot before using the camera.
.....

.....
Tip: The recommended use for the front-facing camera is for video chat. Use the camera so the person you call can see you while you can see them on the screen.
Normally, the video chat software you are using will provide controls for switching between the front and rear facing cameras.
.....

To activate the camera, open the application menu and tap **Camera**.



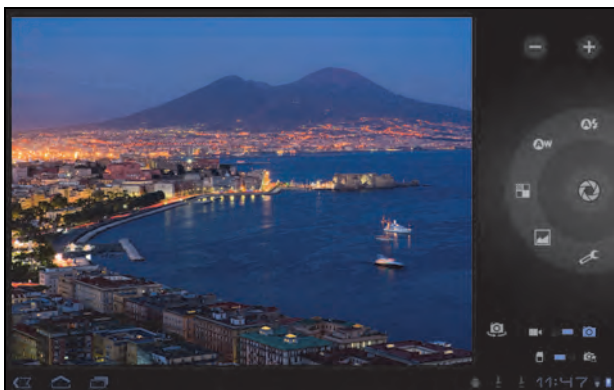









Camera icons and indicators



.....
Note: Not all controls are available when using the front-facing camera.
.....

In the camera window, the controls on the right allow you to zoom, change settings, switch between internal and SD card memory, switch between the front and rear camera, or select camera or camcorder.

After you have taken a photo, a thumbnail in the bottom-left allows you to view the gallery of pictures or videos.

Icon	Description
	Zoom out You may only zoom out after you have zoomed in.
	Zoom in Crop and enlarge the center of the screen.
	Take photo After taking a photo, tap the thumbnail in the bottom-left corner to view the photo in the Gallery.
	Flash mode Choose when to use the flash: Auto, On or Off
	White balance Change the color balance to match the lighting: Auto, Incandescent, Daylight or Fluorescent.
	Color effect Choose an effect to change the colors in your photos: None, Mono, Sepia, Negative, Solarize or Posterize.
	Scene mode Choose a mode to match the type of scene to capture: Auto, Action, Portrait, Landscape, Night, Night portrait, Theatre, Beach, Snow, Sunset, Steady photo, Fireworks.
	Camera settings Activate or change special settings: Store location, Focus mode, Exposure, Picture size, Picture quality, Restore defaults.
	Switch camera Switch between the rear and front cameras.
	Camcorder mode Switches to the camcorder (video recorder).
	Camera mode Switches to the camera.
	Internal memory Saves photos to the tablet's internal memory (this is the default).
	Memory card Saves photos to the memory card in the microSD card slot (only available if a microSD card has been inserted).

Taking a photo

1. Ensure the options described above are set to your preferences.
2. Frame your subject and steady your tablet.
3. Zoom in or out as needed.



Note: When using zoom, the image on the screen does not represent the quality of the final image.

4. Tap the camera icon to take the photo.

After taking a photo, tap the thumbnail in the bottom-left corner to view the photo in the Gallery.

Shooting a video



Note: Not all controls are available when using the front-facing camera.

Tap the camcorder icon to switch to camcorder mode.

Most camcorder settings are the same as the camera settings; if a setting is not described below, then check the camera description.



Icon	Description
	Start / stop recording
	Flash mode Turns the flash on or off.
	Video quality Choose the quality (resolution) of the video: High, Low, YouTube.
	Note: YouTube uses the High quality setting, but is limited to 15 minutes.
	Time lapse interval Shoot a slow motion 'time lapse' video, set the interval between single frames in this menu.

1. Ensure the options described above are set to your preferences.

2. Frame your subject and steady your tablet and zoom in or out as needed.
3. Tap the record icon to begin recording.
4. Tap the record icon to stop recording.



.....
Note: Zoom is only available in certain resolutions.
.....

Supported formats

Type	Formats
Image	JPEG
Video	H.264BP
Audio	AAC-LC

Viewing photos and videos

After you have taken your photo or video, it is automatically saved; normally to internal memory.

After taking a photo or video, you can view it in the Gallery by tapping the thumbnail in the bottom-left corner of the screen. Alternatively, open the application menu and tap **Gallery**, then **Camera**. Select the photo or video you want to view (videos are marked with a small play symbol).

From the Gallery you can share the file directly using various services. Tap **Menu** and then **Share**.



.....
Note: Share options vary depending on the file type.
.....

Using a cellular data network (only for Wi-Fi+3G models)

'3G', or data over a cellular network, is only available on models equipped with a SIM card slot, or through a separate 3G modem (not supplied - available from your mobile Internet provider, check for compatibility).



Important: Please check the information provided by your mobile internet provider. Not all options and settings described in this section will be available, and different applications may be provided.

Installing a SIM card

Certain tablets include a SIM slot for Internet access. To take full advantage of your tablet's Internet capabilities, you should install a SIM card with data subscription *before* turning on your tablet.

1. Turn off the tablet by pressing and holding the power button.
2. Insert the SIM card as shown.

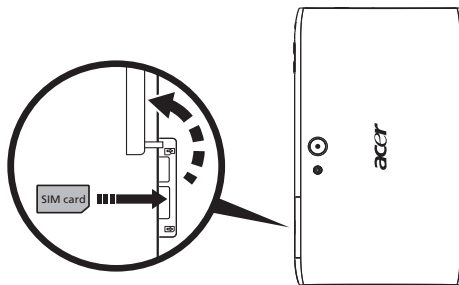

3. Replace the card slot cover.



Note: Ensure that the SIM card is inserted all the way into the card slot.



Caution: Turn off your tablet before installing or removing a SIM card. You may damage the card or your tablet if the power is still on.

Activating a new SIM card and PIN

If you are using a SIM card for the first time, it may require activation. Contact your network operator for details on how to do this.

When you install a SIM card for the first time, you may need to enter a PIN.

Important: Depending on your settings, you may be required to enter your PIN each time you switch on the cellular data function.
.....

SIM card lock

Your tablet may come with a SIM card lock, i.e., you will only be able to use the SIM card provided by your network operator.

To cancel the SIM lock, contact your network provider.

Note: If you need to turn the 3G network on or off see **“Putting your tablet in Airplane mode” on page 55** and **“Activating or deactivating connections” on page 55**.
.....

Adjusting connection settings

Open the Application menu and tap **Apps > Settings > Wireless & networks** to manage your connection settings.

In addition to Wi-Fi and Bluetooth options, if your tablet includes 3G features, some additional options are available:

Item	Description
Tethering & portable hotspot	Shares your tablet’s mobile data connection via USB or as a portable Wi-Fi hotspot.
Mobile networks	Sets your options for connecting to mobile networks.
Internet sharing	Shares your mobile data connection with the connected computer.

Mobile Internet settings

Tap **Apps > Settings > Wireless & networks > Mobile networks** to adjust your network settings. You can turn the data connection on or off when roaming, restrict the connection to 2G networks only, specify a network operator and define access point names.

Selecting a network

Your tablet will automatically detect your carrier/network settings when you insert a new SIM card. However, you may prefer to manually select a network. This is often a good idea when roaming.

Tip: When you are traveling, manually selecting a network may help to reduce your roaming charges. Check with your service provider for the network offering the most competitive rates at your destination.
.....

Disable data when roaming

You can prevent your tablet from transmitting data over other carriers' mobile networks when you are traveling and leave an area that is covered by your carrier's networks. This is useful for controlling expenses if your mobile data contract doesn't include data roaming.

1. Tap **Apps > Settings > Wireless & networks > Mobile networks**.
2. Tap **Data roaming** to disable it (remove the green tick).

Limit your data connection to slower networks

If your tablet connects to 3G mobile networks, you can extend your battery life by limiting your data connections to slower, 2G networks (GPRS or EDGE). When you are connected to a 2G network, you may want to postpone activities that transmit a lot of data, such as sending, uploading, or downloading pictures or video, until you are connected to a faster mobile or other wireless network.

1. Tap **Apps > Settings > Wireless & networks > Mobile networks**.
2. Tap **Use only 2G networks**.

Creating a new access point

When you need to add another GPRS/3G/EDGE connection on your tablet, obtain the access point name and settings (including username and password if required) from your service provider.

1. Tap **Apps > Settings > Wireless & networks > Mobile networks > Access Point Names**.
2. Tap an existing APN, or tap **New APN**.
3. Enter the APN settings. Tap an item to adjust it.
4. When you have finished tap **Save**.
5. If you want to use the new or edited APN, tap the APN in the list.



.....
Important: Some providers and countries do not allow the use of a tablet as a modem over HSDPA. Please check with your provider before attempting to do so.
.....

Internet sharing

Tethering via USB

If you wish to share your mobile Internet connection with a computer, you can connect your tablet to a PC using the supplied micro USB cable.

1. Plug the USB sync cable into the micro USB port on your tablet.
2. Plug the USB client connector into an available USB port on your computer.
3. Alternatively, you can tap **Apps > Settings > Wireless & networks > Tethering & portable hotspot** and then tap **USB tethering**.

Wi-Fi hotspot

You can turn your tablet into a portable Wi-Fi hotspot to share your mobile Internet connection with up to eight clients.

1. Tap **Apps > Settings > Wireless & networks > Tethering & portable hotspot**.
2. Tap **Portable Wi-Fi hotspot** and **Portable Wi-Fi hotspot settings**.
3. Tap **Configure Wi-Fi hotspot** to set the Network SSID and adjust security settings (such as adding a password).
4. Tap **Save** to finish.

Advanced settings

To access Settings from the Application menu. Tap **Apps > Settings**.

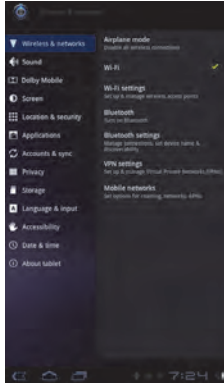

Sound

Adjust the volume of your tablet using the volume buttons on the side of the tablet. Alternatively, you can adjust your tablet sound settings by tapping **Apps > Settings > Sound**.

Item	Description
Volume	Sets volume for Media, Alarm, and Notifications.
Notification ringtone	Sets a ringtone for Notifications.
Audible touch tones	Plays tones when using the dial pad.
Audible selection	Plays a sound whenever a screen selection is made.
Screen lock sounds	Plays a sound when locking and unlocking the screen.
Haptic feedback	Vibrates when pressing soft keys and on certain UI interactions.

Screen

You can adjust your tablet screen settings by tapping **Apps > Settings > Screen**.

Item	Description
Brightness	Adjusts screen brightness.
Animation	Enables window animations.
Timeout	Sets a delay before the screen will be turned off.

Putting your tablet in Airplane mode

You can enter Airplane mode (also known as flight mode) to turn off network and Bluetooth functions and use your tablet during a flight. Check with your airline to make sure this is permitted onboard.

Switch your tablet off during takeoff and landing as it may interfere with aircraft electronic systems.



Note: When Airplane mode is active, the  icon is displayed in the status area.

Turn Airplane mode on or off by tapping **Settings > Wireless & networks > Airplane mode**.

Activating or deactivating connections

Open the Application menu and tap **Apps > Settings > Wireless & networks** to manage your connection settings.

Each connection will have a green check when turned on.

Alternatively, you can tap on the right side of the status bar to manage connection settings.

Adjusting connection settings

This section will show you how to adjust detailed settings for your data, Wi-Fi and Bluetooth connections.

Item	Description
Airplane mode	Disables all wireless connections so you can safely use this device onboard an aircraft.
Wi-Fi	Turns the Wi-Fi function on or off.
Wi-Fi settings	Sets up and manages your wireless access points.
Bluetooth	Turns the Bluetooth function on or off.
Bluetooth settings	Manages your Bluetooth connections, sets a device name and discoverability.
VPN settings	Sets up and manages Virtual Private Networks.

If your tablet includes 3G features, some additional options are available:

Item	Description
Tethering & portable hotspot	Shares your tablet's mobile data connection via USB or as a portable Wi-Fi hotspot.
Mobile networks	Sets your options for connecting to mobile networks.
Internet sharing	Shares your mobile data connection with the connected computer.

Adjusting Bluetooth settings

You can use Bluetooth to exchange information between your tablet and other mobile devices.

Bluetooth connections

For all Bluetooth settings, tap **Apps > Settings > Wireless & networks > Bluetooth settings**. Here you can switch Bluetooth on or off, set a device name and discoverability. Tap **Find nearby devices** to scan for available devices.

To connect to a device, tap the device in the list of available devices. You may be asked to enter a PIN on both devices to establish the connection.



.....
Note: Only A2DP stereo headsets (without microphone) are supported.
Please check for updates to the tablet's software which may add support for additional Bluetooth devices.
.....

Connecting to a PC

If you wish to transfer information between your tablet and your computer, you can connect your tablet to a PC using the supplied micro USB cable. Plug the USB sync cable into the micro USB port on your tablet. Plug the USB client connector into an available USB port on your computer.



.....
Note: You may need to install drivers on your computer before your tablet can be used with your computer.
.....

You will now be able to see your tablet's internal memory as a drive in your computer's file explorer.

Synchronization

You can configure synchronization options for many applications on your tablet. You can also configure what types of data you synchronize for each account.

Some applications, such as Contacts, Gmail, and Calendar, can sync data from multiple accounts. Others sync data only from the first Google Account you sign in to on your tablet, or from an account associated specifically with that application.

For some applications, such as Contacts or Calendar, all changes that you make on your tablet are made to the synchronised copy on the Internet. Other applications only copy information from account on the Internet; the information on your tablet cannot be changed directly, you must change the information stored in the Internet account.

Tap **Apps > Settings > Accounts & sync** to access the synchronization settings.

To manage synchronization of individual accounts, tap an account name.

Some applications, such as Gmail and Calendar, have their own synchronization settings. Open the application and tap the *Menu* button (four bars) and then tap **Accounts**.



Auto-sync

To have your tablet auto-sync, make sure **Background data** and **Auto-sync** are enabled.

- If *Background data* is enabled, applications can transmit and receive data when you are not using them.
- If *Auto-sync* is enabled, all changes are automatically transferred between your tablet and Internet accounts.

Acer Sync

Acer Sync allows you to easily synchronize your contacts, calendar, photos and videos between your tablet, PC and corresponding Google services. You must install the Acer Sync program on your computer; download and install Acer Sync and Acer PIM for the PC from the mobile.acer.com website.

Multiple Google accounts

If you have multiple Google accounts, such as separate accounts for personal and business contacts, you can access and synchronize them from the Accounts settings section. Tap **Apps > Settings > Accounts & sync**. Tap **Add account** in the top-right corner and select **Google**.

Setting the date and time

To set the date and time, tap **Apps > Settings > Date & time**.



.....
Tip: If you travel frequently or live in an area that uses daylight saving time, and have mobile network access, activate **Automatic date & time** from this menu. Your tablet will set the date and time based on information it receives from the network.
.....

Setting alarms

There are two predefined alarms on your tablet by default. To add or edit alarm settings, tap **Clock** in the application menu and tap **Set alarm**.

Tap **Add alarm** to create a new alarm, or tap the check box next to a preset alarm to turn it on or off.

Tap a preset alarm to edit it. You can:

- Turn the alarm on or off.
- Set the alarm time.
- Set which days to repeat the alarm.
- Set a ringtone.
- Enable or disable vibrate.
- Give it a label (i.e., a name).

Changing language and text options

Set your location and language input preferences by opening the application menu and going to **Apps > Settings > Language & input**.

Managing applications

You can allow programs from **Unknown sources** to be installed and **Manage applications**.

Closing an application

To close an active application, go to **Settings > Applications > Manage applications**. Tap the **Running** tab, then tap the program you wish to close. Select **Force stop** to close the program.

Uninstalling an application

You can remove programs installed on your tablet to free up extra storage memory. Tap and hold a program icon from the application menu and drag it into the **Uninstall** area in the top-right corner.



.....
Note: You cannot uninstall applications that were pre-loaded on your tablet.
.....

Alternatively, you can go to **Apps > Settings** and select **Applications > Manage applications**. Tap the application you wish to uninstall, tap **Uninstall** and confirm the uninstall.



.....
Warning! You should only remove programs if you are familiar with the Android operating system.
.....

Updating your tablet's operating system

Your tablet can download and install system updates, adding support for new devices or expanding software options.

To check for updates, tap **Apps > Settings > About tablet > System update > Check now**.



.....
Note: Downloading new firmware can take up to 40 minutes, depending on your network speed.
.....

Resetting your tablet

You may have to perform a reset if your tablet fails to respond when buttons are pressed or the screen is tapped.

To reset your tablet use a small thin object (such as a paperclip) to press the recessed reset button.

Clean boot

A clean boot will restore your tablet to the factory settings.



.....
Warning! This will erase all your personal information, any contacts stored on your tablet and any programs you installed.
.....

Open **Settings** from the application menu, then tap **Privacy > Factory data reset**; click **Reset tablet** and then **Erase everything** to format your tablet.



.....
Note: If you are experiencing problems with your tablet, please read "**FAQ and troubleshooting**" on **page 60** before performing a clean boot.
.....

Appendix

FAQ and troubleshooting

This section lists frequently asked questions that may arise during the use of your tablet, and gives easy answers and solutions to these questions.

Aspect	Question	Answer
Audio	Why is there no sound coming from the device?	If the headset is plugged into the device, the speaker is automatically shut off. Disconnect the headset. Check that the device volume setting is not muted. Check that the volume control is not at its lowest setting.
Multimedia files	Why can't I view my picture files?	You may be trying to view an image format that is not supported. Refer to "Multimedia" on page 62 for more information.
	Why can't I view my video files?	You may be trying to view a video format that is not supported. Refer to "Multimedia" on page 62 for more information.
	Why can't I play my music files?	You may be trying to play a file that is not supported. Refer to "Multimedia" on page 62 for more information.
System information and performance	How do I check the OS version of my device?	Tap Apps > Settings > About tablet to check the OS version (Kernel/build number) and other hardware and software information.
Power	I couldn't turn on the device.	The battery power may be depleted. Recharge the device. Refer to "Charging your tablet" on page 11 for more information.
Storage	How do I check memory status?	To check storage status, go to Settings > Storage .

Aspect	Question	Answer
Unlock pattern	I forgot my unlock pattern.	<p>After a certain number of wrong entries, you will be presented with an option to reset your pattern. Tap Forgot pattern? and enter your Google account username and password.</p> <p>ⓘ Note: You must have an active Google account on the tablet. </p> <p>Alternatively, you can clean boot the tablet and erase all data. See “Clean boot” on page 59.</p>
Heat	The tablet heats up when charging or operating for a long period.	<p>It is normal for the device to heat up when charging. When charging is complete, it will return to its normal temperature.</p> <p>It is also normal for the tablet to heat up during long periods of use, such as watching a video or playing a game.</p> <p>All Acer tablets are factory-tested before release.</p>

Other sources of help

For information on:	Refer to:
Up-to-date information regarding your tablet	www.acer.com
Service enquiries	support.acer.com

Specifications

Performance

- NVIDIA® Tegra™ 2 mobile processor
 - Dual-core ARM® Cortex™-A9
- System memory:
 - 1 GB of RAM
 - 8 or 16 GB of flash memory
- Android™ operating system

Display

- 7" WSVGA TFT-LCD capacitive multi-touch screen
- 1024 x 600 resolution
- 262K color support

Multimedia

- Micro (Type D) HDMI output
- CD-quality stereo output
- Stereo speakers
- Single microphone with noise and echo cancellation
- Dolby Mobile

Formats supported:

Type	Formats
Audio recording	AAC-LC, AMR-WB
Audio playback	AAC-LC, AAC, AAC+ (Not raw AAC), AMR-NB, AMR-WB, MP3, OGG Vorbis, WAV
Video recording	H.264 BP, MPEG-4 SP, H.263
Video playback	H.264 BP, H.264 MP, H.264 HP, MPEG-4 SP, H.263
Image	JPEG, GIF, PNG, BMP

USB ports

- Micro USB port (slave)

Power

- DC power-in (12 V, 1.5 A)

Connectivity

- Bluetooth 2.1+EDR & A2DP support
- Wi-Fi 802.11b/g/n WLAN (802.11n -> 2.4 GHz only)
- GPS

3G support (only available on Wi-Fi+3G models)

- aGPS
- GSM 850 / 900 / 1800 / 1900
- UMTS 850 / 900 / 1900 / 2100
- HSDPA 7.2 Mbps / HSUPA 5.76 Mbps / EDGE / GPRS
- Optional HSDPA 21 Mbps

Camera

- Front camera
 - 2-megapixel
 - Fixed focus
- Rear camera
 - 5-megapixel
 - Flash
 - Auto focus

Expansion

- microSD memory card slot (up to 32 GB)

Battery

- Rechargeable high density Li-ion batteries: 1530 mAh x 2 (11.3 Wh)



.....
Note: Length of battery operation will depend on power consumption which is based on system resource use. For example, constantly using the backlight or using power-demanding applications will shorten battery life between charges.
.....

Dimensions

Height	195 mm
Width	117 mm
Thickness	13.1 mm

Environment

Temperature

Operating: 0 °C to 45 °C

Non-operating: -20 °C to 60 °C

Humidity (non-condensing)

Operating: 20% to 80%

Non-operating: 20% to 80%

Safety

Prevention of hearing loss



.....
Warning! Permanent hearing loss may occur if earphones or headphones are used at high volume for prolonged periods of time.
.....

This device has been tested to comply with the Sound Pressure Level requirement laid down in the applicable EN 50332-1 and/or EN 50332-2 standards.



.....
Note: For France, mobile headphones or earphones for this device have been tested to comply with the Sound Pressure requirement laid down in the applicable NF EN 50332-1:2000 and/or NF EN 50332-2:2003 standards as required by French Article L. 5232-1.
.....

A pleine puissance, l'écoute prolongée du baladeur peut endommager l'oreille de l'utilisateur.

Listening precautions

To protect your hearing, follow these precautions.

- Increase the volume gradually until you can hear clearly and comfortably.
- Do not increase the volume level after your ears have adjusted.
- Do not listen to music at high volumes for extended periods.
- Do not increase the volume to block out noisy surroundings.
- Decrease the volume if you can't hear people speaking near you.

Radio Frequency Interference



.....
Warning! For safety reasons, turn off all wireless or radio transmitting devices when using your device under the following conditions. These devices may include, but are not limited to: wireless LAN (WLAN), Bluetooth and/or 3G.
.....

Remember to follow any special regulations in force in any area, and always switch off your device when its use is prohibited or when it may cause interference or danger. Use the device only in its normal operating positions. To successfully transmit data files or messages, this device requires a good quality connection to the network. In some cases, transmission of data files or messages may be delayed until such a connection is available. Ensure that the above separation distance instructions are followed until the transmission is completed. Parts of the device are magnetic. Metallic materials may be attracted to the device, and persons with hearing aids should not hold the device to the ear with the hearing aid. Do not place credit cards or other

magnetic storage media near the device, because information stored on them may be erased.

Medical devices

Operation of any radio transmitting equipment, including wireless phones, may interfere with the functionality of inadequately protected medical devices.

Consult a physician or the manufacturer of the medical device to determine if they are adequately shielded from external RF energy or if you have any questions. Switch off your device in health care facilities when any regulations posted in these areas instruct you to do so. Hospitals or health care facilities may be using equipment that could be sensitive to external RF transmissions.

Pacemakers

Pacemaker manufacturers recommend that a minimum separation of 15.3 cm (6") be maintained between wireless devices and a pacemaker to avoid potential interference with the pacemaker. These recommendations are consistent with the independent research by and recommendations of Wireless Technology Research. Persons with pacemakers should do the following:

- Always keep the device more than 15.3 cm (6") from the pacemaker.
- Not carry the device near your pacemaker when the device is switched on. If you suspect interference, switch off your device, and move it.

Hearing aids

Some digital wireless devices may interfere with some hearing aids. If interference occurs, consult your service provider.

Vehicles

RF signals may affect improperly installed or inadequately shielded electronic systems in motor vehicles such as electronic fuel injection systems, electronic antiskid (antilock) braking systems, electronic speed control systems, and air bag systems. For more information, check with the manufacturer, or its representative, of your vehicle or any equipment that has been added. Only qualified personnel should service the device, or install the device in a vehicle. Faulty installation or service may be dangerous and may invalidate any warranty that may apply to the device. Check regularly that all wireless equipment in your vehicle is mounted and operating properly. Do not store or carry flammable liquids, gases, or explosive materials in the same compartment as the device, its parts, or enhancements. For vehicles equipped with an air bag, remember that air bags inflate with great force. Do not place objects, including installed or portable wireless equipment in the area over the air bag or in the air bag deployment area. If in-vehicle wireless equipment is improperly installed, and the air bag inflates, serious injury could result. Using your device while flying in aircraft is prohibited. Switch off your device before boarding an aircraft. The use of wireless teledevices in an aircraft may be dangerous to the operation of the aircraft, disrupt the wireless telephone network, and may be illegal.

Potentially explosive environments

Switch off your device when in any area with a potentially explosive atmosphere and obey all signs and instructions. Potentially explosive atmospheres include areas where you would normally be advised to turn off your vehicle engine. Sparks in such areas could cause an explosion or fire resulting in bodily injury or even death. Switch off the device at refueling points such as near gas pumps at service stations. Observe restrictions on the use of radio equipment in fuel depots, storage, and distribution areas; chemical plants; or where blasting operations are in progress. Areas with a potentially explosive atmospheres are often, but not always, clearly marked. They include below deck on boats, chemical transfer or storage facilities, vehicles using liquefied petroleum gas (such as propane or butane), and areas where the air contains chemicals or particles such as grain, dust or metal powders.

Follow any restrictions. Do not use the device where blasting is in progress.

Emergency calls

(only for models supporting phone function)



.....
Important: Wireless products, including this device, operate using radio signals, wireless networks, landline networks, and user-programmed functions. Because of this, connections in all conditions cannot be guaranteed. You should never rely solely on any wireless device for essential communications like medical emergencies.
.....

If certain features are in use, you may first need to turn those features off before you can make an emergency call. Consult this guide or your service provider for more information.

When making an emergency call, give all the necessary information as accurately as possible. Your wireless device may be the only means of communication at the scene of an accident. Do not end the call until given permission to do so.

Operation environment

Make sure that the device:

- Is away from magnetic fields or any device generating static electricity.
- Is kept at least 30 centimetres (one foot) away from a mobile phone.
- Is not in a dusty or damp environment.
- Is not used near water. Never spill liquids of any kind on or into your device.
- Cables are not strained and that there is no risk of people walking or tripping over them.
- Other devices do not crush the cables.
- Always unplug your device from the power outlet before cleaning it.
- Do not use liquid or aerosol cleaners, use a damp cloth instead.
- Never spray cleaning product directly on the screen.

- If you spill liquid on your device, switch it off immediately, unplug the AC adapter. Do not attempt to service your device yourself, as opening or removing covers may expose you to dangerous voltage or other risks. Refer all servicing to qualified service personnel.

Unplug your device from the wall outlet and refer servicing to qualified service personnel when:

- The power cord or plug is damaged, cut or frayed.
- Liquid was spilled into the product.
- The product was exposed to rain or water.
- The product has been dropped or the case has been damaged.
- The product exhibits a distinct change in performance, indicating a need for service.



.....
Note: Adjust only those controls that are covered by the operating instructions, since improper adjustment of other controls may result in damage and will often require extensive work by a qualified technician to restore the product to normal condition.

Battery information

This product uses a Lithium-ion battery. Do not use it in a humid, wet and/or corrosive environment. Do not put, store or leave your product in or near a heat source, in a high temperature location, in strong direct sunlight, in a microwave oven or in a pressurized container, and do not expose it to temperatures over 60 °C (140 °F). Failure to follow these guidelines may cause the battery to leak acid, become hot, explode or ignite and cause injury and/or damage. Do not pierce, open or disassemble the battery. If the battery leaks and you come into contact with the leaked fluids, rinse thoroughly with water and seek medical attention immediately. For safety reasons, and to prolong the lifetime of the battery, charging will not occur at low (below 0 °C/32 °F) or high (over 40 °C/104 °F) temperatures.

The full performance of a new battery is achieved only after two or three complete charge and discharge cycles. The battery can be charged and discharged many times, but it will eventually wear out. When normal use and standby times are noticeably shorter than normal, contact your reseller. Use only manufacturer approved batteries, and recharge your battery only with manufacturer approved chargers designated for this device.

Unplug the charger from the electrical plug and the device when not in use. If left unused, a fully charged battery will lose its charge over time. If the battery is completely discharged, it may take a few minutes before the charging indicator appears on the display or before the device can be used.

Use the battery only for its intended purpose. Never use any charger or battery that is damaged.

Do not short-circuit the batteries under any condition. Accidental short-circuiting can occur when a metallic object such as a coin, clip, or pen causes direct connection of the positive (+) and negative (-) terminals of the battery.

These look like metal strips on the battery. This might happen, for example, when you carry a spare battery in your pocket or purse. Short-circuiting the terminals may damage the battery or the connecting object.

Leaving the battery or any device with embedded batteries in hot or cold places, such as in a closed car in summer or winter conditions, will reduce the capacity and lifetime of the battery. Always try to keep the battery between 15 °C and 25 °C (59 °F and 77 °F). A device with a hot or cold battery may not work temporarily, even when the battery is fully charged. Battery performance is particularly limited in temperatures well below freezing.

Do not dispose of battery or devices with embedded batteries in a fire as they may explode. Batteries may also explode if damaged. Dispose of batteries according to local regulations. Please recycle when possible. Do not dispose as household waste.

- Avoid leaving this device or battery in your car in high temperatures.
- Avoid dropping this device or battery. It can cause damage.
- Contact your service provider or reseller to have them checked if this device or battery get wet or damaged from dropping or high temperature.

Replacing the battery

Use original products for quality assurance and safeguards. If the battery cannot be removed and replaced, contact your dealer.



.....
Warning! Use of a non-original battery or charger may present a risk of fire, explosion, leakage, or other hazard.
.....



.....
Warning! Batteries may explode if not handled properly. Do not disassemble or dispose of them near fire. Keep them away from children. Follow local regulations when disposing of used batteries.
.....

IEEE1625 statement (only for Wi-Fi+3G models)

- Do not disassemble or open, crush, bend or deform, puncture, or shred.
- Do not modify or remanufacture, attempt to insert foreign objects into the battery, immerse or expose to water or other liquids, or expose to excessive heat, fire, or other hazard. Only use the battery in the system for which it was specified.
- Only use the battery with a charging system that has been qualified with the system per this standard.
- Use of an unqualified battery or charger may present a risk of fire, explosion, leakage, or other hazard.
- Do not short-circuit a battery or allow metallic or conductive objects to contact the battery terminals.
- Replace the battery only with another battery that has been qualified with the system per this standard.

- Use of an unqualified battery may present a risk of fire, explosion, leakage, or other hazard.
- Promptly dispose of used batteries in accordance with local regulations.
- Battery usage by children should be supervised.
- Avoid dropping the host or battery. If the host or battery is dropped, especially on a hard surface, and the end user suspects damage, take it to a service center for inspection.
- Improper battery use may result in a fire, explosion, leakage, or other hazard.
- Storage and operating conditions, including temperature, shall be specified.

Driving safety

Using this device while driving may cause distraction. Stop using it if you can't concentrate on driving. Input information about your destination and route prior to your drive. Do not input data or engage in text messaging while driving. Keep your eyes on the road while driving. Listen to the audible turn-by-turn directions, if available. Also, using a mobile device or accessory may be prohibited or restricted in certain areas. Always obey the laws and regulations on the use of these products.

GPS and aGPS (for certain models only)

- Your device may use Global Positioning System (GPS) signals for location-based applications. GPS uses satellites controlled by the U.S. government that are subject to changes implemented in accordance with the Department of Defense policy and the Federal Radio Navigation Plan. These changes may affect the performance of location technology on your device.
- Your device may also use Assisted Global Positioning System (aGPS), which obtains information from a cellular network to improve GPS performance. aGPS uses your wireless service provider's network and therefore airtime, data charges, and/or additional charges may apply in accordance with your service plan. Contact your wireless service provider for details.
- Devices enabled with GPS or aGPS technology transmit location-based information. This location-based information may be shared with third parties, including your wireless service provider, application providers, and other third parties providing service.

Emergency calls

- When you make an emergency call, the cellular network may activate the aGPS technology in your mobile device to tell the emergency responders your approximate location.
- aGPS has limitations and might not work in your area. Therefore:
 - Always tell the emergency responder your location to the best of your ability, and
 - Remain on the device for as long as the emergency responder instructs you.

- Get better performance by going outside and away from underground locations, covered vehicles, structures with metal or concrete roofs, tall buildings, and foliage.
- Indoor performance might improve if move closer to windows, but some windows sun shielding films can block satellite signals.
- Get better performance by moving away from radios, entertainment equipment, and other electronic devices.

Keep away from children

- Keep your device and its accessories away from small children, a choking hazard may exist for small, detachable parts.
- Improper use may cause loud sounds, possibly causing hearing injury.
- Improperly handled this device or batteries could overheat and cause a burn.

Glass parts

Some parts of your device may be made of glass. This glass could break if the product is dropped on a hard surface or receives a substantial impact. If glass breaks, do not touch or attempt to remove. Stop using your device until the glass is replaced by a qualified service center.

Seizures/Blackouts/Eyestrain

A small percentage of people may be susceptible to blackouts or seizures (even if they have never had one before) when exposed to flashing lights or light patterns such as when playing games or watching video. If you have experienced seizures or blackouts or have a family history of such occurrences, you should consult a physician before playing games or watching videos on your device. Discontinue use and consult a physician if any of the following symptoms occur: convulsion, eye or muscle twitching, loss of awareness, involuntary movements, or disorientation. It is always a good idea to hold the screen away from your eyes, leave the light on in the room, take a not-less-than-15-minute break every hour, and stop use it if you are tired.

Repetitive motion

When you repetitively perform actions such as pressing keys or entering finger-written characters, you may experience occasional discomfort in your hands, arms, shoulders, neck, or other parts of your body. If you continue to have discomfort during or after such use, stop use and see a physician.

Use of connectors and ports

Never force a connector into a port. Check for obstructions on the port. If the connector and port don't join with reasonable ease, they probably don't match. Make sure that the connector matches the port and that you have positioned the connector correctly in relation to the port.

Information from World Health Organization

Present scientific information does not indicate the need for any special precautions for the use of mobile device. If you are concerned, you may want to limit your own or your children's RF exposure by limiting the length of calls or

by using handsfree devices to keep mobile devices away from your head and body.

Source: WHO Fact Sheet 193

Further information: www.who.int/peh-emf

Consumer information on wireless device

The U.S. Food and Drug Administration (FDA) has published a series of Questions and Answer for consumers relating to radio frequency (RF) exposure from wireless phone devices: www.fda.gov/Radiation-EmittingProducts/RadiationEmittingProductsandProcedures/HomeBusinessandEntertainment/CellPhones/default.htm

Additional information on the safety of RF exposures:

FCC RF Safety program: www.fcc.gov/oet/rfsafety

Environmental Protection Agency (EPA): www.epa.gov/radiation

International Commission on Non-Ionizing Radiation Protection: www.icnirp.de

Export Law Assurances

This product, including any software or technical data contained in or accompanying the product, may be subject to import and export regulations of the European Union, the United States of America, Canada and other countries/regions. The Government of those countries/regions may restrict the exportation or re-exportation of this product to certain destinations. For further information refer to European Council Regulation (EC) 1334/2000, contact the U.S. Department of Commerce or the Canadian Department of Foreign Affairs and International Trade, and other local government authorities.

Protection of personal information

Erase personal data before disposing of the product. To delete data, perform a master reset. Deleting data from the device memory does not ensure that it cannot be recovered.

Disposal and recycling information



Do not throw this electronic device into the trash when discarding.

To minimize pollution and ensure utmost protection of the global environment, please recycle. For more information on the Waste from Electrical and Electronics Equipment (WEEE) regulations, visit www.acer-group.com/public/Sustainability/sustainability01.htm

RoHS compliance

This product is in compliance with Directive 2002/95/EC of the European Parliament and of the Council of 27 January 2003, on the restriction of the use of certain hazardous substances in electrical and electronic equipment (RoHS) and its amendments.

Disposal of your device packaging and product guide should be in accordance with national collection and recycling requirements. Contact your regional authorities for more details.

LCD pixel statement

The LCD unit is produced with high-precision manufacturing techniques. Nevertheless, some pixels may occasionally misfire or appear as black or red dots. This has no effect on the recorded image and does not constitute a malfunction.

Radio device regulatory notice



.....
Note: Regulatory information below is for models with wireless LAN and/or Bluetooth only.
.....

General

This product complies with the radio frequency and safety standards of any country or region in which it has been approved for wireless use. Depending on configuration, this product may or may not contain wireless radio devices (such as wireless LAN and/or Bluetooth modules). Information below is for products with such devices.

Wireless operation channels for different domains

N. America	2.412-2.462 GHz	Ch01 through Ch11
Japan	2.412-2.484 GHz	Ch01 through Ch14
Europe ETSI	2.412-2.472 GHz	Ch01 through Ch13

This equipment is in compliance with the essential requirements and other relevant provisions of Directive 1999/5/EC.

France: Restricted wireless frequency bands

Some areas of France have a restricted frequency band. The worst case maximum authorized power indoors is:

- 10 mW for the entire 2.4 GHz band (2400 MHz - 2483.5 MHz)
- 100 mW for frequencies between 2446.5 MHz and 2483.5 MHz



.....
Note: Channels 10 through 13 inclusive operate in the band 2446.6 MHz to 2483.5 MHz.
.....

There are few possibilities for outdoor use: On private property or on the private property of public persons, use is subject to a preliminary authorization procedure by the Ministry of Defense, with maximum authorized power of 100 mW in the 2446.5 - 2483.5 MHz band. Use outdoors on public property is not permitted in the departments listed below, for the entire 2.4 GHz band:

- Maximum authorized power indoors is 100 mW

- Maximum authorized power outdoors is 10 mW

Departments in which the use of the 2400 - 2483.5 MHz band is permitted with an EIRP of less than 100 mW indoors and less than 10 mW outdoors:

01 Ain Orientales	25 Doubs	59 Nord	75 Paris
02 Aisne	26 Drome	60 Oise	82 Tarn et Garonne
03 Allier	32 Gers	61 Orne	84 Vaucluse
05 Hautes Alpes	36 Indre	63 Puy Du Dome	88 Vosges
08 Ardennes	37 Indre et Loire	64 Pyrenees Atlantique	89 Yonne
09 Ariège	41 Loir et Cher	66 Pyrenees	90 Territoire de Belfort
11 Aude	45 Loret	67 Bas Rhin	94 Val de Marne
12 Aveyron	50 Manche	68 Haut Rhin	
16 Charente	55 Meuse	70 Haute Saone	
24 Dordogne	58 Nievre	71 Saone et Loire	

This requirement is likely to change over time, allowing you to use your wireless LAN card in more areas within France. Please check with ART for the latest information (www.art-telecom.fr).



Note: Your WLAN Card transmits less than 100 mW, but more than 10 mW.

List of National Codes

This equipment may be operated in the following countries:

Country	ISO 3166 2 letter code	Country	ISO 3166 2 letter code	Country	ISO 3166 2 letter code	Country	ISO 3166 2 letter code
Austria	AT	Germany	DE	Malta	MT	United Kingdom	GB
Belgium	BE	Greece	GR	Netherlands	NT	Iceland	IS
Cyprus	CY	Hungary	HU	Poland	PL	Liechtenstein	LI
Czech Republic	CZ	Ireland	IE	Portugal	PT	Norway	NO
Denmark	DK	Italy	IT	Slovakia	SK	Switzerland	CH
Estonia	EE	Latvia	LV	Slovenia	SL	Bulgaria	BG
Finland	FI	Lithuania	LT	Spain	ES	Romania	RO
France	FR	Luxembourg	LU	Sweden	SE	Turkey	TR

FCC regulations

This mobile device complies with part 15 of the FCC Rules. Operation is subject to the following two conditions:

1. This device may not cause harmful interference, and
2. this device must accept any interference received, including interference that may cause undesired operation.

This mobile device has been tested and found to comply with the limits for a Class B digital device, pursuant to Part 15 of the FCC Rules. These limits are designed to provide reasonable protection against harmful interference in a residential installation. This equipment generates, uses and can radiated radio frequency energy and, if not installed and used in accordance with the

instructions, may cause harmful interference to radio communications. However, there is no guarantee that interference will not occur in a particular installation. If this equipment does cause harmful interference to radio or television reception, which can be determined by turning the equipment off and on, the user is encouraged to try to correct the interference by one or more of the following measures:

- Reorient or relocate the receiving antenna.
- Increase the separation between the equipment and receiver.
- Connect the equipment into an outlet on a circuit different from that to which the receiver is connected.
- Consult the dealer or an experienced radio/TV technician for help.

Changes or modifications not expressly approved by the party responsible for compliance could void the user's authority to operate the equipment.

RF exposure warning

The equipment complies with FCC RF exposure limits set forth for an uncontrolled environment.

The antenna(s) used for this transmitter must not be co-located or operating in conjunction with any other antenna or transmitter.

For Canada

Operation is subject to the following two conditions:

1. This device may not cause interference.
2. This device must accept any interference, including interference that may cause undesired operation of the device.

This Class B digital apparatus complies with Canadian ICES-003.

This Category II radiocommunication device complies with Industry Canada Standard RSS-310.

Le présent appareil est conforme aux CNR d'Industrie Canada applicables aux appareils radio exempts de licence. L'exploitation est autorisée aux deux conditions suivantes :

1. L'appareil ne doit pas produire de brouillage, et
2. L'utilisateur de l'appareil doit accepter tout brouillage radioélectrique subi, même si le brouillage est susceptible d'en compromettre le fonctionnement.

Cet appareil numérique de la classe B est conforme à la norme NMB-003 du Canada.

Ce dispositif de radiocommunication de catégorie II respecte la norme CNR-310 d'Industrie Canada.

Regulatory information

Compliant with Russian regulatory certification.



NCC 警語

經型式認證合格之低功率射頻電機、非經許可、公司、商號或使用者均不得擅自變更頻率、加大功率或變更原設計之特性及功能。

低功率射頻電機之使用不得影響飛航安全及干擾合法通信；經發現有干擾現象時、應立即停用、並改善至無干擾時方得繼續使用。

前項合法通信、指依電信法規定作業之無線電通信。

低功率射頻電機須忍受合法通信或工業、科學及醫療用電波輻射性電機設備之干擾。

* 減少電磁波影響、請妥善使用。（* 僅限電話手機機種）

Lithium-ion / Li-polymer battery warning



ATTENZIONE! Rischio di esplosione della batteria se sostituita in modo errato. Sostituire la batteria con un una di tipo uguale o equivalente consigliata dalla fabbrica. Non disperdere le batterie nell'ambiente.



VORSICHT! Explosionsgefahr bei unsachgemäßen Austausch der Batterie. Ersatz nur durch denselben oder einem vom Hersteller empfohlenem ähnlichen Typ. Entsorgung gebrauchter Batterien nach Angaben des Herstellers.



ADVARSEL! Lithiumbatteri - Eksplosionsfare ved fejlagtig håndtering. Udskiftning må kun ske med batteri af samme fabrikat og type. Levér det brugte batteri tilbage til leverandøren.



WARNING! Explosionsfara vid felaktigt batteribyte. Använd samma batterityp eller en ekvivalent typ som rekommenderas av apparattillverkaren. Kassera använt batteri enligt fabrikantens instruktion.



VAROITUS! Paristo voi räjähtää, jos se on virheellisesti asennettu. Vaihda paristo ainoastaan laitevalmistajan suosittelemaan tyyppiin. Hävitä käytetty paristo valmistajan ohjeiden mukaisesti.



ATTENTION ! Il y a danger d'explosion s'il y a remplacement incorrect de la batterie. Remplacer uniquement avec une batterie du même type ou d' un type équivalent recommandé par le constructeur. Mettre au rebut les batteries usagées conformément aux instructions du fabricant.



ADVARSEL! Eksplosjonsfare ved feilaktig skifte av batteri. Benytt samme batteritype eller en tilsvarende type anbefalt av apparatfabrikanten. Brukte batterier kasseres i henhold til fabrikantens instruksjoner.

RF exposure information (SAR)

This device meets the government's requirements for exposure to radio waves.

This device is designed and manufactured not to exceed the emission limits for exposure to radio frequency (RF) energy set by the Federal Communications Commission of the U.S. Government.

The exposure standard for wireless devices employs a unit of measurement known as the Specific Absorption Rate, or SAR. The SAR limit set by the FCC is 1.6 W/kg.

Tests for SAR are conducted using standard operating positions accepted by the FCC with the device transmitting at its highest certified power level in all tested frequency bands. Although the SAR is determined at the highest certified power level, the actual SAR level of the device while operating can be well below the maximum value. This is because the device is designed to operate at multiple power levels so as to use only the power required to reach the network. In general, the closer you are to a wireless base station antenna, the lower the power output.



Important: Body-worn measurements differ among device models, depending upon available enhancements and FCC requirements.

While there may be differences between the SAR levels of various devices and at various positions, they all meet the government requirements.

The FCC has granted an Equipment Authorization for this model device with all reported SAR levels evaluated as in compliance with the FCC RF exposure guidelines. SAR information on this model of device is on file with the FCC and can be found under the Display Grant section of www.fcc.gov/oet/ea/fccid after searching on FCC ID: HLZTMDMA100.

For body worn operation, this device has been tested and meets the FCC RF exposure guidelines for use with accessories that contain no metal and that position the device a minimum of 0 cm from the body when the device is switched on.

Certificate Information (SAR)

This device meets the EU requirements (1999/519/EC) on the limitation of exposure of the general public to electromagnetic fields by way of health protection.

The limits are part of extensive recommendations for the protection of the general public. These recommendations have been developed and checked by independent scientific organizations through regular and thorough evaluations of scientific studies. To guarantee the safety of all persons, regardless of age and health, the limits include a significant safety buffer.

Before radio devices can be put in circulation, their agreement with European laws or limits must be confirmed; only then may the CE symbol be applied.

The unit of measurement for the European Council's recommended limit for mobile devices is the "Specific Absorption Rate" (SAR). This SAR limit is 2.0 W/kg, averaged over 10 g of body tissue. It meets the requirements of the International Commission on Non-Ionizing Radiation Protection (ICNIRP). The maximum SAR value is calculated at the highest output level in all frequency bands of the mobile device.

For body worn operation, this device has been tested and meets the ICNIRP exposure guidelines and was included in the European Standard EN 62311 and EN 62209-2 for use with accessories that contain no metal and that position the device a minimum of 1.5 cm from the body when the device is switched on. Use of other accessories may not ensure compliance with ICNIRP exposure guidelines.

During use, the actual SAR level is usually much lower than the maximum value, because the mobile device works in different output levels. It only transmits with as much output as is required to reach the network. In general the following applies: The closer you are to a base station, the lower the transmission output of your mobile device.

Certification marks and Compliance

Region	Certification and Compliance
E.U.	   

Model	FCC ID	IC ID
A100	HLZTMDMA100	1754F-TMDMA100

You can view certification logos on your device: open **Settings** > **About tablet** > **Legal information** > **Certification Logo**.

For users in Canada

Important note

IC radiation exposure statement

This EUT is compliance with SAR for general population/uncontrolled exposure limits in IC RSS-102 and had been tested in accordance with the measurement methods and procedures specified in IEEE 1528. This equipment should be installed and operated with minimum distance 0 cm between the radiator and your body.

This device and its antenna(s) must not be co-located or operating in conjunction with any other antenna or transmitter.



.....
Note: The country code selection feature is disabled for products marketed in the US/Canada.

For users in Thailand

This telecommunication equipment conforms to the requirements of the National Telecommunications Commission.

Declaration of Conformity

We, Acer Incorporated,
of 8F., No. 88, Sec. 1, Xintai 5th Rd., Xizhi Dist, New Taipei City, 22181, Taiwan

Declare under sole responsibility that the product:

Model: A100

Description: Tablet Computer

To which this declaration relates, is in conformity with the following standards and/or other normative documents:

- EN 300 328 V1.7.1
- EN 300 440-1 V1.6.1 ; EN300 440-2 V1.4.1
- EN 301 489-1 V1.8.1 ; EN 301489-3 V1.4.1 ; EN 301489-17 V2.1.1
- EN 55022:2006/A1:2007 Class B ; EN 55024:1998/A1:2001/A2:2003
- EN 60950-1: 2006+A11:2009
- EN 50332-2: 2003
- EN62311:2008; EN62209-2:2010

We hereby declare that the above named product is in conformance to all the essential requirements of the R&TTE Directive (99/5/EC) issued by the Commission of the European Community.

The conformity assessment procedure referred to in Article 10 and detailed in Annex [IV] of directive 1999/5/EC has been followed related to Articles:

- R&TTE Article 3.1 (a) Health and Safety
- R&TTE Article 3.1 (b) EMC
- R&TTE Article 3.2 Spectrum Usage

with the involvement of the following Notified Body:

CETECOM, Untertuerkheimer Str. 6 – 10 66117 Saarbruecken

Identification mark: 0682 (Notified Body) CE

The technical documentation relevant to the above equipment will be held at:

Acer Incorporated

8F., No. 88, Sec. 1, Xintai 5th Rd., Xizhi Dist, New Taipei City, 22181, Taiwan

Authorized person:



Name: Harriot SL Lee